

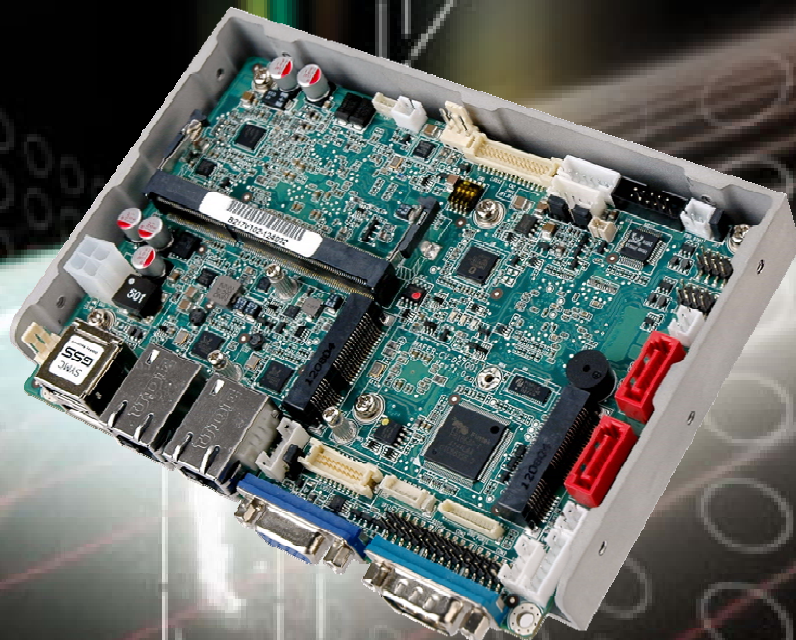

IEI Technology Corp.



**MODEL:**

**WAFFER-CV-D25501/N26001**

**3.5" SBC with Intel® Atom™ D2550/N2600 Processor,  
DDR3, VGA/Dual LVDS, Dual PCIe GbE, USB 2.0,  
PCIe Mini, SATA 3Gb/s, Audio and RoHS**

## **User Manual**

Rev. 1.03 – 11 December, 2012



# Revision

Date	Version	Changes
11 December, 2012	1.03	Added CN6 connector information
23 November, 2012	1.02	Updated the note for the Intel® GMA driver limitation
13 August, 2012	1.01	Added a note for the Intel® GMA driver limitation
26 June, 20	1.00	Initial release

# Copyright

---

## **COPYRIGHT NOTICE**

The information in this document is subject to change without prior notice in order to improve reliability, design and function and does not represent a commitment on the part of the manufacturer.

In no event will the manufacturer be liable for direct, indirect, special, incidental, or consequential damages arising out of the use or inability to use the product or documentation, even if advised of the possibility of such damages.

This document contains proprietary information protected by copyright. All rights are reserved. No part of this manual may be reproduced by any mechanical, electronic, or other means in any form without prior written permission of the manufacturer.

## **TRADEMARKS**

All registered trademarks and product names mentioned herein are used for identification purposes only and may be trademarks and/or registered trademarks of their respective owners.

# Table of Contents

<b>1 INTRODUCTION.....</b>	<b>1</b>
1.1 INTRODUCTION.....	2
1.2 MODEL VARIATIONS .....	2
1.3 CONNECTORS .....	3
1.4 DIMENSIONS.....	4
1.5 DATA FLOW .....	6
1.6 TECHNICAL SPECIFICATIONS .....	7
<b>2 PACKING LIST.....</b>	<b>9</b>
2.1 ANTI-STATIC PRECAUTIONS .....	10
2.2 UNPACKING PRECAUTIONS.....	10
2.3 PACKING LIST.....	11
2.4 OPTIONAL ITEMS .....	12
<b>3 CONNECTORS .....</b>	<b>13</b>
3.1 PERIPHERAL INTERFACE CONNECTORS.....	14
3.1.1 WAFER-CV-D25501/N26001 Layout .....	14
3.1.2 Peripheral Interface Connectors .....	15
3.1.3 External Interface Panel Connectors.....	16
3.2 INTERNAL PERIPHERAL CONNECTORS .....	16
3.2.1 5 V SATA Power Connectors.....	16
3.2.2 12 V Power Connector.....	17
3.2.3 Audio Connector .....	17
3.2.4 Backlight Inverter Connectors.....	18
3.2.5 Battery Connector.....	19
3.2.6 Digital Input/Output (DIO) Connector.....	20
3.2.7 Fan Connectors.....	21
3.2.8 Keyboard/Mouse Connector .....	22
3.2.9 LVDS1 Connector .....	23
3.2.10 LVDS2 Connector .....	24
3.2.11 LVDS2 Backlight Control Connector.....	26

## WAFER-CV-D25501/N26001 3.5" Motherboard

3.2.12	PCIe Mini Card Slots.....	26
3.2.13	Power & HDD LED Connector.....	28
3.2.14	Power Button Connector.....	29
3.2.15	Reset Button Connector.....	30
3.2.16	RS-232 Serial Port Connectors.....	30
3.2.17	RS-422/485 Serial Port Connector.....	31
3.2.18	SATA Drive Connectors.....	32
3.2.19	USB Connectors.....	33
3.3	EXTERNAL PERIPHERAL INTERFACE CONNECTOR PANEL.....	34
3.3.1	Ethernet Connectors.....	34
3.3.2	Serial Port Connector (COM1).....	35
3.3.3	USB Connectors.....	36
3.3.4	VGA Connector.....	36
<b>4</b>	<b>INSTALLATION.....</b>	<b>38</b>
4.1	ANTI-STATIC PRECAUTIONS.....	39
4.2	INSTALLATION CONSIDERATIONS.....	39
4.3	SO-DIMM INSTALLATION.....	41
4.4	JUMPER SETTINGS.....	42
4.4.1	AT/ATX Power Selection Jumper.....	42
4.4.2	Clear CMOS Jumper.....	43
4.4.3	LVDS1 Voltage Selection.....	44
4.4.4	LVDS2 Voltage Selection.....	45
4.4.5	LVDS2 Panel Type Selection Jumper.....	46
4.5	CHASSIS INSTALLATION.....	47
4.5.1	Airflow.....	47
4.5.2	Motherboard Installation.....	48
4.6	INTERNAL PERIPHERAL DEVICE CONNECTIONS.....	48
4.6.1	Audio Kit Installation.....	48
4.6.2	LVDS LCD Installation.....	49
4.6.3	Full-size PCIe Mini Card Installation.....	51
4.6.4	Half-size PCIe Mini Card Installation.....	53
4.6.5	SATA Drive Connection.....	54
4.6.6	Single RS-232 Cable.....	55
4.6.7	Keyboard/Mouse Y-cable Connector.....	56

4.7 EXTERNAL PERIPHERAL INTERFACE CONNECTION .....	58
4.7.1 LAN Connection.....	58
4.7.2 Serial Device Connection .....	59
4.7.3 USB Connection (Dual Connector).....	60
4.7.4 VGA Monitor Connection .....	60
4.8 HEAT SINK ENCLOSURE.....	62
<b>5 BIOS.....</b>	<b>64</b>
5.1 INTRODUCTION.....	65
5.1.1 Starting Setup.....	65
5.1.2 Using Setup .....	65
5.1.3 Getting Help.....	66
5.1.4 Unable to Reboot after Configuration Changes .....	66
5.1.5 BIOS Menu Bar.....	66
5.2 MAIN.....	67
5.3 ADVANCED .....	68
5.3.1 ACPI Settings .....	68
5.3.2 RTC Wake Settings .....	69
5.3.3 CPU Configuration.....	71
5.3.4 IDE Configuration .....	72
5.3.5 USB Configuration.....	73
5.3.6 F81866 Super IO Configuration.....	74
5.3.6.1 Serial Port n Configuration .....	74
5.3.7 F81866 H/W Monitor.....	78
5.3.7.1 Smart Fan Mode Configuration .....	79
5.3.8 Serial Port Console Redirection .....	80
5.3.9 iEi Feature .....	83
5.4 CHIPSET .....	84
5.4.1 Host Bridge Configuration .....	84
5.4.1.1 Intel IGD Configuration.....	85
5.4.2 South Bridge Configuration.....	87
5.5 BOOT.....	88
5.6 SECURITY.....	90
5.7 EXIT .....	90
<b>6 SOFTWARE DRIVERS .....</b>	<b>92</b>

## WAFER-CV-D25501/N26001 3.5" Motherboard

6.1 AVAILABLE SOFTWARE DRIVERS .....	93
6.2 STARTING THE DRIVER PROGRAM .....	93
6.3 CHIPSET DRIVER INSTALLATION.....	95
6.4 GRAPHICS DRIVER INSTALLATION.....	99
6.5 LAN DRIVER INSTALLATION.....	103
6.6 AUDIO DRIVER INSTALLATION .....	105
<b>A BIOS OPTIONS .....</b>	<b>108</b>
<b>B ONE KEY RECOVERY .....</b>	<b>111</b>
B.1 ONE KEY RECOVERY INTRODUCTION .....	112
<i>B.1.1 System Requirement.....</i>	<i>113</i>
<i>B.1.2 Supported Operating System.....</i>	<i>114</i>
B.2 SETUP PROCEDURE FOR WINDOWS .....	115
<i>B.2.1 Hardware and BIOS Setup .....</i>	<i>116</i>
<i>B.2.2 Create Partitions .....</i>	<i>116</i>
<i>B.2.3 Install Operating System, Drivers and Applications.....</i>	<i>120</i>
<i>B.2.4 Build-up Recovery Partition.....</i>	<i>121</i>
<i>B.2.5 Create Factory Default Image.....</i>	<i>123</i>
B.3 AUTO RECOVERY SETUP PROCEDURE .....	128
B.4 SETUP PROCEDURE FOR LINUX .....	133
B.5 RECOVERY TOOL FUNCTIONS .....	136
<i>B.5.1 Factory Restore .....</i>	<i>138</i>
<i>B.5.2 Backup System.....</i>	<i>139</i>
<i>B.5.3 Restore Your Last Backup.....</i>	<i>140</i>
<i>B.5.4 Manual.....</i>	<i>141</i>
B.6 RESTORE SYSTEMS FROM A LINUX SERVER THROUGH LAN .....	142
<i>B.6.1 Configure DHCP Server Settings .....</i>	<i>143</i>
<i>B.6.2 Configure TFTP Settings .....</i>	<i>144</i>
<i>B.6.3 Configure One Key Recovery Server Settings.....</i>	<i>145</i>
<i>B.6.4 Start the DHCP, TFTP and HTTP .....</i>	<i>146</i>
<i>B.6.5 Create Shared Directory.....</i>	<i>146</i>
<i>B.6.6 Setup a Client System for Auto Recovery .....</i>	<i>147</i>
B.7 OTHER INFORMATION .....	150
<i>B.7.1 Using AHCI Mode or ALi M5283 / VIA VT6421A Controller.....</i>	<i>150</i>
<i>B.7.2 System Memory Requirement .....</i>	<i>152</i>



**C TERMINOLOGY ..... 153**

**D DIGITAL I/O INTERFACE..... 157**

    D.1 INTRODUCTION..... 158

    D.2 DIO CONNECTOR PINOUTS ..... 158

    D.3 ASSEMBLY LANGUAGE SAMPLES..... 159

*D.3.1 Enable the DIO Input Function ..... 159*

*D.3.2 Enable the DIO Output Function..... 159*

**E WATCHDOG TIMER..... 160**

**F HAZARDOUS MATERIALS DISCLOSURE..... 163**

    F.1 HAZARDOUS MATERIALS DISCLOSURE TABLE FOR IPB PRODUCTS CERTIFIED AS  
    ROHS COMPLIANT UNDER 2002/95/EC WITHOUT MERCURY ..... 164



# List of Figures

Figure 1-1: WAFER-CV-D25501/N26001 .....	2
Figure 1-2: Connectors .....	3
Figure 1-3: WAFER-CV-D25501/N26001 Dimensions (mm).....	4
Figure 1-4: External Interface Panel Dimensions (mm).....	5
Figure 1-5: Data Flow Diagram.....	6
Figure 3-1: Connectors and Jumpers.....	14
Figure 3-2: 5 V SATA Power Connector Locations .....	16
Figure 3-3: 12 V Power Connector Location.....	17
Figure 3-4: Audio Connector Location .....	18
Figure 3-5: Backlight Inverter Connector Locations.....	19
Figure 3-6: Battery Connector Location.....	20
Figure 3-7: Digital I/O Connector Location .....	21
Figure 3-8: Fan Connector Locations.....	22
Figure 3-9: Keyboard/Mouse Connector Location .....	23
Figure 3-10: LVDS1 Connector Location .....	24
Figure 3-11: LVDS2 Connector Location .....	25
Figure 3-12: LVDS2 Backlight Control Connector Location .....	26
Figure 3-13: PCIe Mini Card Slot Locations.....	27
Figure 3-14: Power & HDD LED Connector Location.....	28
Figure 3-15: Power Button Connector Location.....	29
Figure 3-16: Reset Button Connector Location.....	30
Figure 3-17: RS-232 Serial Port Connector Locations.....	31
Figure 3-18: RS-422/485 Connector Location.....	32
Figure 3-19: SATA Drive Connector Locations .....	32
Figure 3-20: USB Connector Locations.....	33
Figure 3-21: External Peripheral Interface Connector .....	34
Figure 3-22: RJ-45 Ethernet Connector.....	35
Figure 3-23: COM1 Pinout Locations.....	36
Figure 3-24: VGA Connector .....	37
Figure 4-1: SO-DIMM Installation .....	41

Figure 4-2: AT/ATX Power Selection Jumper Location .....	43
Figure 4-3: Clear CMOS Jumper Location .....	44
Figure 4-4: LVDS1 Voltage Selection Jumper Location .....	45
Figure 4-5: LVDS2 Voltage Selection Jumper Location .....	46
Figure 4-6: LVDS2 Panel Type Selection Switch Location.....	47
Figure 4-7: Audio Kit Cable Connection.....	49
Figure 4-8: LVDS Connector.....	50
Figure 4-9: Backlight Inverter Connection.....	51
Figure 4-10: Remove the Retention Screw for the Full-size PCIe Mini Card .....	52
Figure 4-11: Insert the Full-size PCIe Mini Card into the Socket at an Angle.....	52
Figure 4-12: Secure the Full-size PCIe Mini Card.....	53
Figure 4-13: Remove the Retention Screws for the Half-size PCIe Mini Card.....	53
Figure 4-14: Insert the Half-size PCIe Mini Card into the Socket at an Angle .....	54
Figure 4-15: Secure the Half-size PCIe Mini Card .....	54
Figure 4-16: SATA Drive Cable Connection.....	55
Figure 4-17: Single RS-232 Cable Installation .....	56
Figure 4-18: Keyboard/mouse Y-cable Connection .....	57
Figure 4-19: LAN Connection .....	58
Figure 4-20: Serial Device Connector.....	59
Figure 4-21: USB Connector.....	60
Figure 4-22: VGA Connector .....	61
Figure 4-23: Heat Sink Retention Screws .....	63
Figure 6-1: Start Up Screen .....	94
Figure 6-2: Drivers .....	94
Figure 6-3: Chipset Driver Screen.....	95
Figure 6-4: Chipset Driver Welcome Screen.....	96
Figure 6-5: Chipset Driver License Agreement .....	97
Figure 6-6: Chipset Driver Read Me File .....	97
Figure 6-7: Chipset Driver Setup Operations .....	98
Figure 6-8: Chipset Driver Installation Finish Screen.....	99
Figure 6-9: Graphics Driver Welcome Screen .....	100
Figure 6-10: Graphics Driver License Agreement.....	101
Figure 6-11: Graphics Driver Read Me File .....	101
Figure 6-12: Graphics Driver Setup Operations .....	102
Figure 6-13: Graphics Driver Installation Finish Screen .....	102

## WAFER-CV-D25501/N26001 3.5" Motherboard

Figure 6-14: LAN Driver Welcome Screen .....	103
Figure 6-15: LAN Driver Installation .....	104
Figure 6-16: LAN Driver Installation Complete.....	104
Figure 6-17: Audio Driver Installation File Extraction.....	105
Figure 6-18: Audio Driver Welcome Screen.....	106
Figure 6-19: Audio Driver Installation.....	106
Figure 6-20: Audio Driver Installation Complete .....	107
Figure B-1: IEI One Key Recovery Tool Menu .....	112
Figure B-2: Launching the Recovery Tool .....	117
Figure B-3: Recovery Tool Setup Menu .....	117
Figure B-4: Command Prompt .....	118
Figure B-5: Partition Creation Commands.....	119
Figure B-6: Launching the Recovery Tool .....	121
Figure B-7: Manual Recovery Environment for Windows .....	121
Figure B-8: Building the Recovery Partition.....	122
Figure B-9: Press Any Key to Continue .....	122
Figure B-10: Press F3 to Boot into Recovery Mode.....	123
Figure B-11: Recovery Tool Menu .....	123
Figure B-12: About Symantec Ghost Window.....	124
Figure B-13: Symantec Ghost Path .....	124
Figure B-14: Select a Local Source Drive .....	125
Figure B-15: Select a Source Partition from Basic Drive .....	125
Figure B-16: File Name to Copy Image to .....	126
Figure B-17: Compress Image.....	126
Figure B-18: Image Creation Confirmation .....	127
Figure B-19: Image Creation Complete .....	127
Figure B-20: Image Creation Complete .....	127
Figure B-21: Press Any Key to Continue .....	128
Figure B-22: Auto Recovery Utility .....	129
Figure B-23: Disable Automatically Restart.....	129
Figure B-24: Launching the Recovery Tool .....	130
Figure B-25: Auto Recovery Environment for Windows .....	130
Figure B-26: Building the Auto Recovery Partition.....	131
Figure B-27: Factory Default Image Confirmation .....	131
Figure B-28: Image Creation Complete .....	132



Figure B-29: Press any key to continue ..... 132

Figure B-30: IEI Feature ..... 133

Figure B-31: Partitions for Linux..... 134

Figure B-32: System Configuration for Linux..... 135

Figure B-33: Access menu.lst in Linux (Text Mode)..... 135

Figure B-34: Recovery Tool Menu ..... 136

Figure B-35: Recovery Tool Main Menu ..... 137

Figure B-36: Restore Factory Default..... 138

Figure B-37: Recovery Complete Window ..... 138

Figure B-38: Backup System..... 139

Figure B-39: System Backup Complete Window ..... 139

Figure B-40: Restore Backup ..... 140

Figure B-41: Restore System Backup Complete Window ..... 140

Figure B-42: Symantec Ghost Window ..... 141

Figure B-43: Disable Automatically Restart..... 148

# List of Tables

<b>Table 1-1: WAFER-CV-D25501/N26001 Model Variations .....</b>	<b>2</b>
<b>Table 1-2: WAFER-CV-D25501/N26001 Specifications .....</b>	<b>8</b>
<b>Table 2-1: Packing List.....</b>	<b>12</b>
<b>Table 2-2: Optional Items .....</b>	<b>12</b>
<b>Table 3-1: Peripheral Interface Connectors .....</b>	<b>15</b>
<b>Table 3-2: Rear Panel Connectors .....</b>	<b>16</b>
<b>Table 3-3: 5 V SATA Power Connector Pinouts .....</b>	<b>17</b>
<b>Table 3-4: 12 V Power Connector Pinouts .....</b>	<b>17</b>
<b>Table 3-5: Audio Connector Pinouts .....</b>	<b>18</b>
<b>Table 3-6: Backlight Inverter Connector Pinouts .....</b>	<b>19</b>
<b>Table 3-7: Battery Connector Pinouts .....</b>	<b>20</b>
<b>Table 3-8: Digital I/O Connector Pinouts.....</b>	<b>21</b>
<b>Table 3-9: Fan Connector Pinouts .....</b>	<b>22</b>
<b>Table 3-10: Keyboard/Mouse Connector Pinouts .....</b>	<b>23</b>
<b>Table 3-11: LVDS1 Connector Pinouts.....</b>	<b>24</b>
<b>Table 3-12: LVDS2 Connector Pinouts.....</b>	<b>25</b>
<b>Table 3-13: LVDS2 Backlight Control Connector Pinouts.....</b>	<b>26</b>
<b>Table 3-14: PCIe Mini Card Slot Pinouts .....</b>	<b>28</b>
<b>Table 3-15: Power &amp; HDD LED Connector Pinouts .....</b>	<b>29</b>
<b>Table 3-16: Power Button Connector Pinouts .....</b>	<b>29</b>
<b>Table 3-17: Reset Button Connector Pinouts .....</b>	<b>30</b>
<b>Table 3-18: RS-232 Serial Port Connector Pinouts .....</b>	<b>31</b>
<b>Table 3-19: RS-422/485Connector Pinouts .....</b>	<b>32</b>
<b>Table 3-20: SATA Drive Connector Pinouts.....</b>	<b>33</b>
<b>Table 3-21: USB Connector Pinouts .....</b>	<b>34</b>
<b>Table 3-22: LAN Pinouts .....</b>	<b>34</b>
<b>Table 3-23: RJ-45 Ethernet Connector LEDs .....</b>	<b>35</b>
<b>Table 3-24: RS-232 Serial Port (COM 1) Pinouts .....</b>	<b>35</b>
<b>Table 3-25: USB Port Pinouts.....</b>	<b>36</b>
<b>Table 3-26: VGA Connector Pinouts.....</b>	<b>37</b>



<b>Table 4-1: Jumpers .....</b>	<b>42</b>
<b>Table 4-2: AT/ATX Power Selection Jumper Settings.....</b>	<b>43</b>
<b>Table 4-3: Clear CMOS Jumper Settings.....</b>	<b>43</b>
<b>Table 4-4: LVDS1 Voltage Selection Jumper Settings.....</b>	<b>44</b>
<b>Table 4-5: LVDS2 Voltage Selection Jumper Settings.....</b>	<b>45</b>
<b>Table 4-6: LVDS2 Panel Resolution .....</b>	<b>47</b>
<b>Table 5-1: BIOS Navigation Keys .....</b>	<b>66</b>

# BIOS Menus

---

BIOS Menu 1: Main .....	67
BIOS Menu 2: Advanced .....	68
BIOS Menu 3: ACPI Settings .....	69
BIOS Menu 4: RTC Wake Settings .....	70
BIOS Menu 5: CPU Configuration .....	71
BIOS Menu 6: IDE Configuration .....	72
BIOS Menu 7: USB Configuration .....	73
BIOS Menu 8: Super IO Configuration.....	74
BIOS Menu 9: Serial Port n Configuration Menu .....	74
BIOS Menu 10: F81866 H/W Monitor .....	78
BIOS Menu 11: Smart Fan Mode Configuration .....	80
BIOS Menu 12: Serial Port Console Redirection .....	81
BIOS Menu 13: IEI Feature .....	83
BIOS Menu 14: Chipset .....	84
BIOS Menu 15: Host Bridge Configuration .....	85
BIOS Menu 16: Intel IGD Configuration.....	85
BIOS Menu 17: Southbridge Chipset Configuration .....	87
BIOS Menu 18: Boot .....	88
BIOS Menu 19: Security .....	90
BIOS Menu 20:Exit.....	91

Chapter

1

# Introduction

---



## 1.1 Introduction

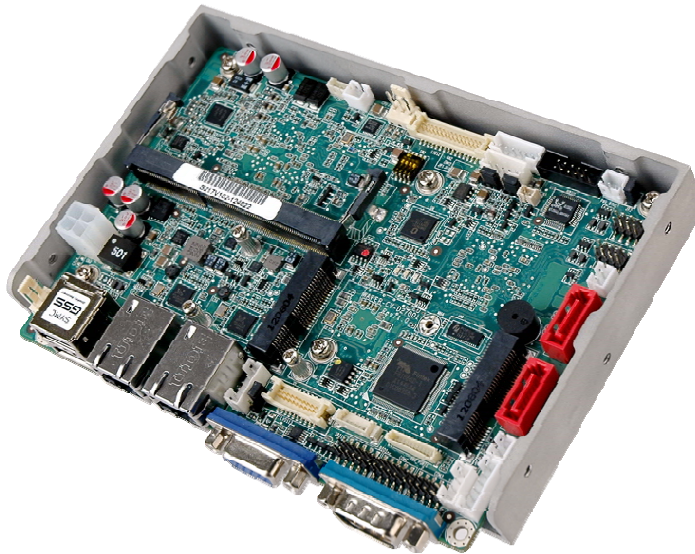

**Figure 1-1: WAFER-CV-D25501/N26001**

The WAFER-CV-D25501/N26001 3.5" motherboard is an Intel® Atom™ D2550/N2600 processor platform that supports one 1066 MHz or 800 MHz DDR3 SO-DIMM memory. The WAFER-CV-D25501/N26001 supports VGA display output and comes with two LVDS connectors supporting 24-bit or 18-bit LVDS screens. Maximum six USB ports, two SATA 3Gb/s connectors, two PCIe Mini card slots, four COM ports, and one audio connector provide flexible expansion options.

## 1.2 Model Variations

The model variations of the WAFER-CV-D25501/N26001 are listed below.

Model No.	CPU
WAFER-CV-D25501-R10	Intel® Atom™ D2550 1.86 GHz
WAFER-CV-N26001-R10	Intel® Atom™ N2600 1.6 GHz

**Table 1-1: WAFER-CV-D25501/N26001 Model Variations**

## WAFER-CV-D25501/N26001 3.5" Motherboard

### 1.3 Connectors

The connectors on the WAFER-CV-D25501/N26001 are shown in the figure below.

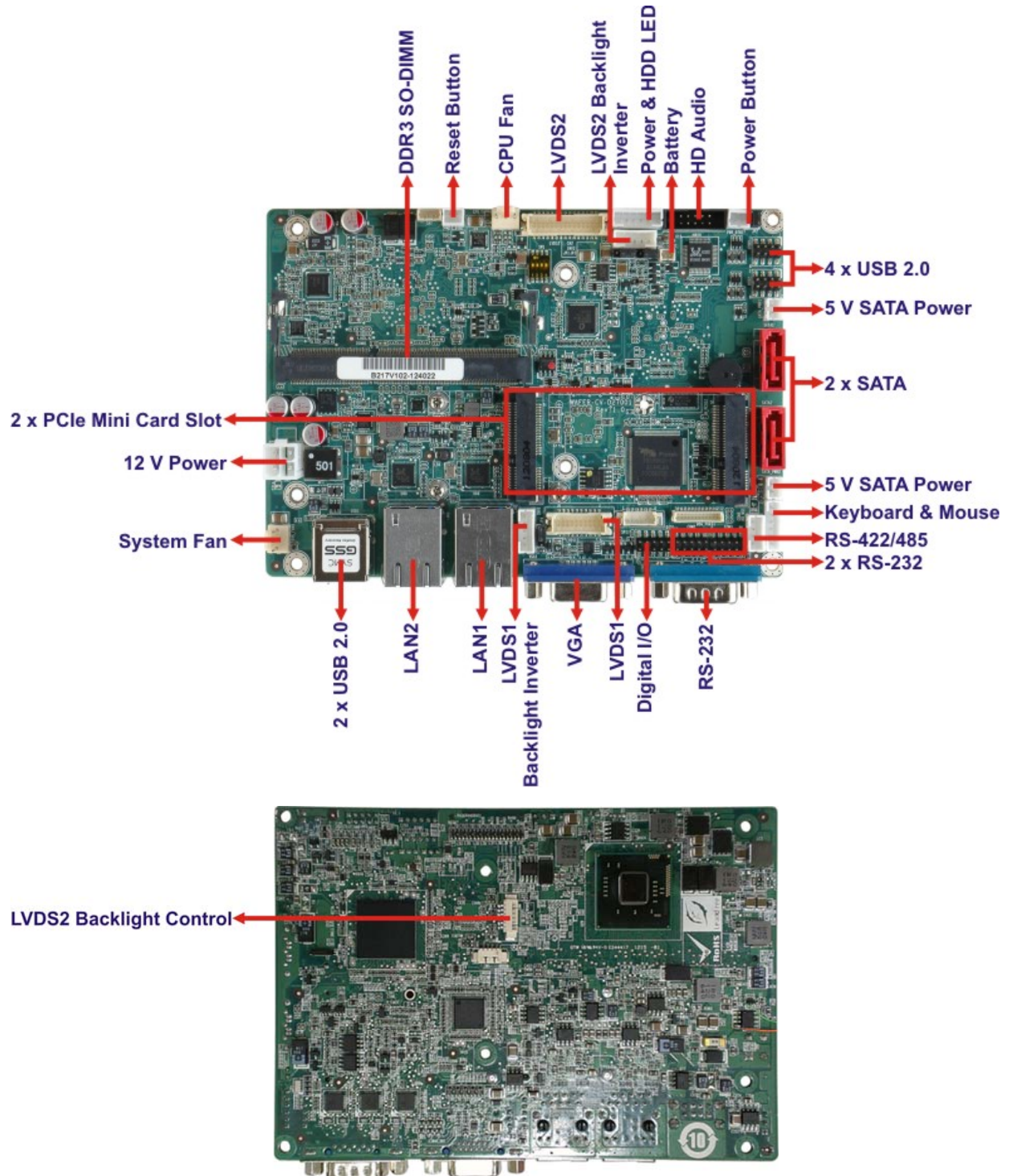

Figure 1-2: Connectors

### 1.4 Dimensions

The main dimensions of the WAFER-CV-D25501/N26001 are shown in the diagram below.

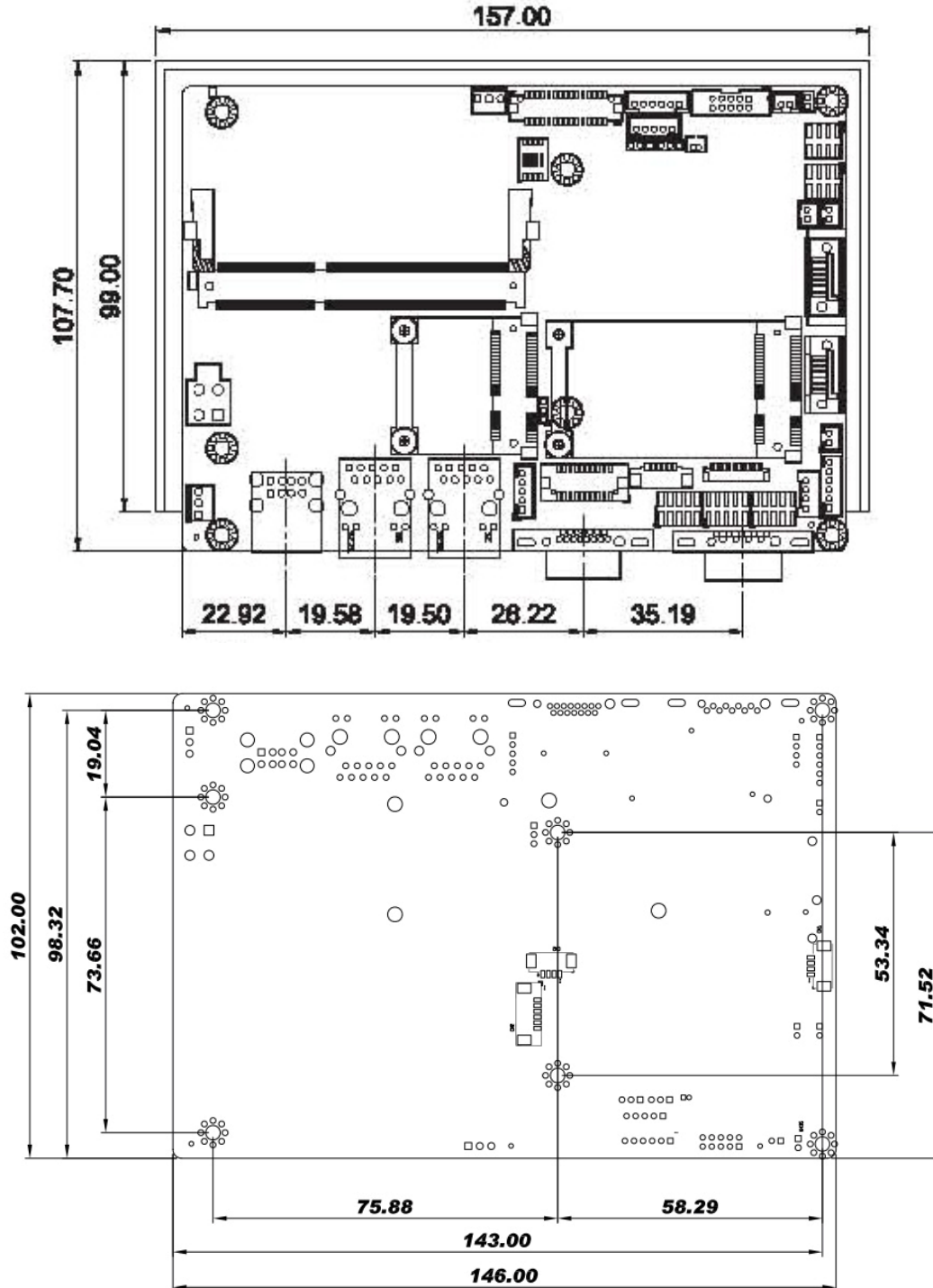
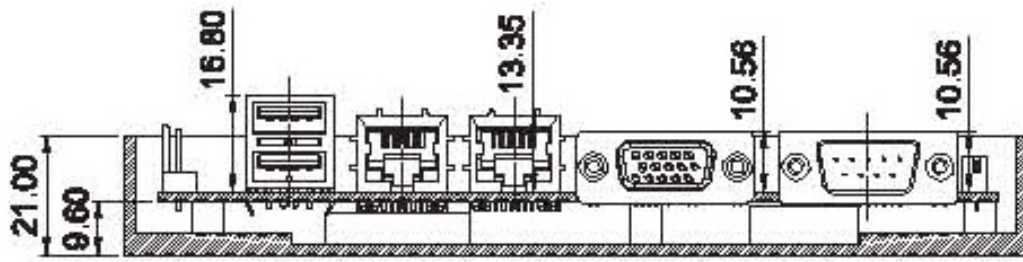

Figure 1-3: WAFER-CV-D25501/N26001 Dimensions (mm)

**WAFER-CV-D25501/N26001 3.5" Motherboard**



**Figure 1-4: External Interface Panel Dimensions (mm)**

### 1.5 Data Flow

Figure 1-5 shows the data flow between the system chipset, the CPU and other components installed on the motherboard.

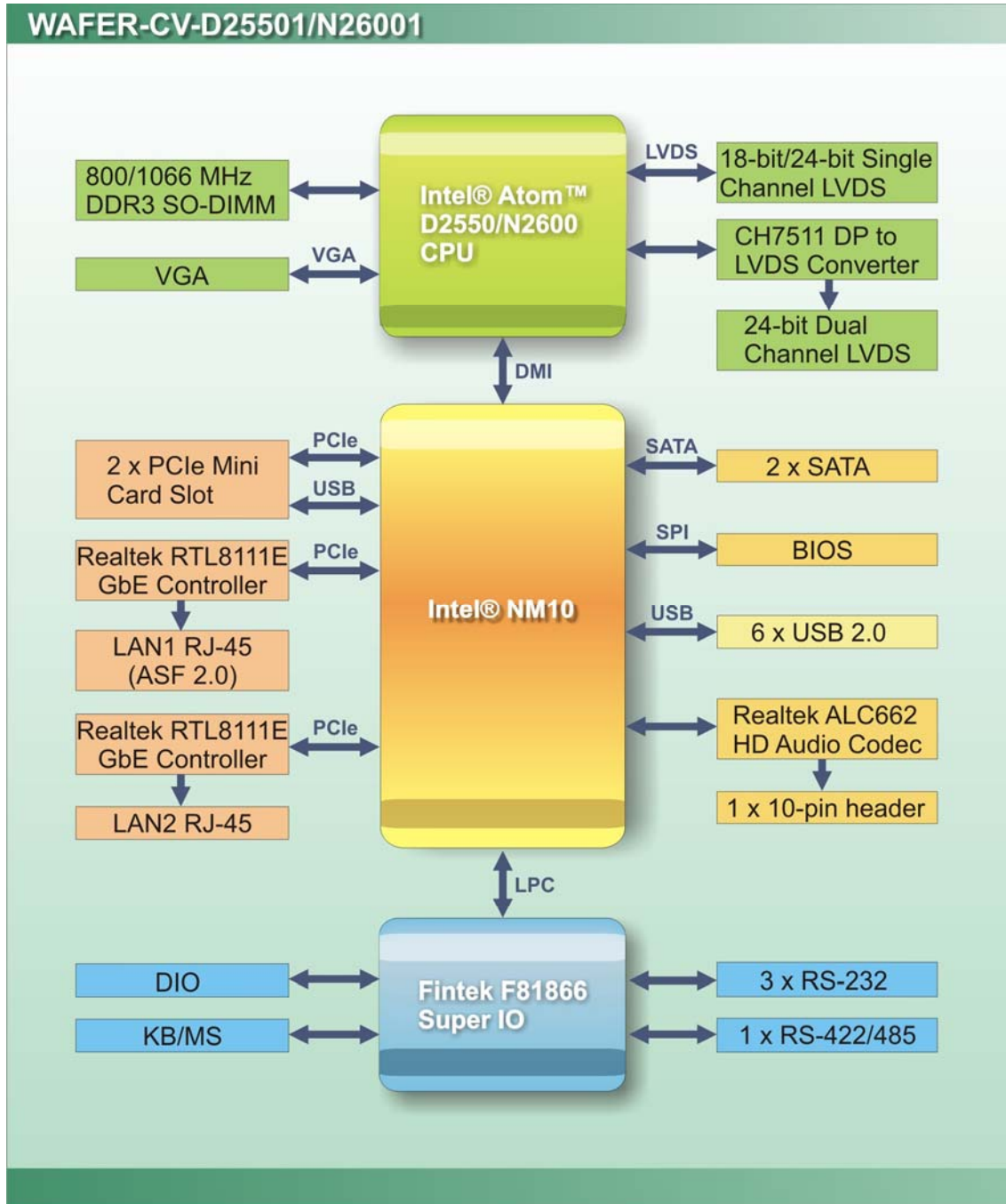

Figure 1-5: Data Flow Diagram

## WAFER-CV-D25501/N26001 3.5" Motherboard

### 1.6 Technical Specifications

The WAFER-CV-D25501/N26001 technical specifications are listed below.

Specification/Model	WAFER-CV-D25501	WAFER-CV-N26001
<b>Form Factor</b>	3.5"	
<b>System CPU</b>	Intel® Atom™ D2550 1.86 GHz	Intel® Atom™ N2600 1.6 GHz
<b>System Chipset</b>	Intel® NM10	
<b>Memory</b>	One 1066 MHz DDR3/DDR3L (1.35V) SO-DIMM support (up to 4 GB)	One 800 MHz DDR3/DDR3L (1.35V) SO-DIMM support (up to 2 GB)
<b>Graphics Engine</b>	Intel® GMA 3650 with a 640 MHz graphics core	Intel® GMA 3600 with a 400 MHz graphics core
<b>Display</b>	Dual display supported One VGA One LVDS1 is integrated in the Intel® Atom™ D2550/N2600 processor One LVDS2 is driven by the Chrontel CH7511 DP to LVDS converter	
	24-bit single-channel LVDS1 with up to 1440x900 resolution	18-bit single-channel LVDS1 with up to 1366x768 resolution
	24-bit dual-channel LVDS2 with up to 1920x1200 resolution	24-bit dual-channel LVDS2 with up to 1600x1200 resolution
<b>Ethernet</b>	Dual Realtek RTL8111E PCIe GbE controller (LAN1 with ASF 2.0 support)	
<b>BIOS</b>	UEFI BIOS	
<b>Super I/O Controller</b>	Fintek F81866	
<b>Watchdog Timer</b>	Software programmable supports 1~255 sec. system reset	
<b>Expansion</b>	One full-size PCIe Mini card slot with mSATA support One half-size PCIe Mini card slot	
<b>Audio</b>	Realtek ALC662 HD Audio codec	
<b>COM</b>	Three RS-232 (one by external connector; two by on-board pin headers) One RS-422/485 by internal 4-pin wafer connector	
<b>Digital I/O</b>	One 8-bit digital input/output connector (4-bit input/4-bit output)	

Specification/Model	WAFER-CV-D25501	WAFER-CV-N26001
<b>Fan</b>	One 3-pin CPU fan connector One 3-pin system fan connector	
<b>Keyboard/mouse</b>	One internal pin-header connector	
<b>SATA</b>	Two SATA 3Gb/s ports with 5V power	
<b>USB</b>	Six USB 2.0/1.1 devices supported: Two by external connectors Four by on-board pin headers	
<b>Power Supply</b>	12 V only AT and ATX support One internal 4-pin (2x2) power connector	
<b>Power Consumption</b>	12V @ 1.53 A (1.86 GHz Intel® Atom™ D2550 with 1 GB 1066 MHz DDR3 SO-DIMM memory)	12V @ 1.15 A (1.6 GHz Intel® Atom™ N2600 with 1 GB 1066 MHz DDR3 SO-DIMM memory)
<b>Operating Temperature</b>	-20°C ~ 60°C with free air -20°C ~ 70°C with force air	-20°C ~ 70°C with free air -20°C ~ 75°C with force air
<b>Storage Temperature</b>	-30°C ~ 80°C	-30°C ~ 85°C
<b>Humidity (Operating)</b>	5% ~ 95% (non-condensing)	
<b>Dimensions (LxW)</b>	146 mm x 102 mm	
<b>Weight (GW/NW)</b>	600 g/250 g	

**Table 1-2: WAFER-CV-D25501/N26001 Specifications**

Chapter

2

# Packing List

---



## 2.1 Anti-static Precautions

---



### WARNING!

Static electricity can destroy certain electronics. Make sure to follow the ESD precautions to prevent damage to the product, and injury to the user.

---

Make sure to adhere to the following guidelines:

- **Wear an anti-static wristband:** Wearing an anti-static wristband can prevent electrostatic discharge.
- **Self-grounding:** Touch a grounded conductor every few minutes to discharge any excess static buildup.
- **Use an anti-static pad:** When configuring any circuit board, place it on an anti-static mat.
- **Only handle the edges of the PCB:** Don't touch the surface of the motherboard. Hold the motherboard by the edges when handling.

## 2.2 Unpacking Precautions

When the WAFER-CV-D25501/N26001 is unpacked, please do the following:

- Follow the antistatic guidelines above.
- Make sure the packing box is facing upwards when opening.
- Make sure all the packing list items are present.

## WAFER-CV-D25501/N26001 3.5" Motherboard







### 2.3 Packing List







#### NOTE:

If any of the components listed in the checklist below are missing, do not proceed with the installation. Contact the IEI reseller or vendor the WAFER-CV-D25501/N26001 was purchased from or contact an IEI sales representative directly by sending an email to [sales@iei.com.tw](mailto:sales@iei.com.tw).

The WAFER-CV-D25501/N26001 is shipped with the following components:



Quantity	Item and Part Number	Image
1	WAFER-CV-D25501/N26001 motherboard	
1	SATA and power cable (P/N: 32801-000201-100-RS)	
1	Audio cable (P/N: 32000-072100-RS)	
1	RS-232 cable (P/N: 32205-002700-100-RS)	
1	KB/MS cable (P/N: 32000-023800-RS)	
1	Power cable (P/N: 32100-087100-RS)	

Quantity	Item and Part Number	Image
1	Mini jumper pack	
1	One Key Recovery CD	
1	Utility CD	
1	Quick Installation Guide	

**Table 2-1: Packing List**

## 2.4 Optional Items

The following are optional components which may be separately purchased:

Item and Part Number	Image
Dual USB cable (wo bracket) (P/N: 32001-008600-100-RS)	
RS-422/485 cable (200 mm) (P/N: 32205-003800-100-RS)	

**Table 2-2: Optional Items**

Chapter

**3**

# Connectors

---

### 3.1 Peripheral Interface Connectors

This chapter details all the jumpers and connectors.

#### 3.1.1 WAFER-CV-D25501/N26001 Layout

The figure below shows all the connectors and jumpers.

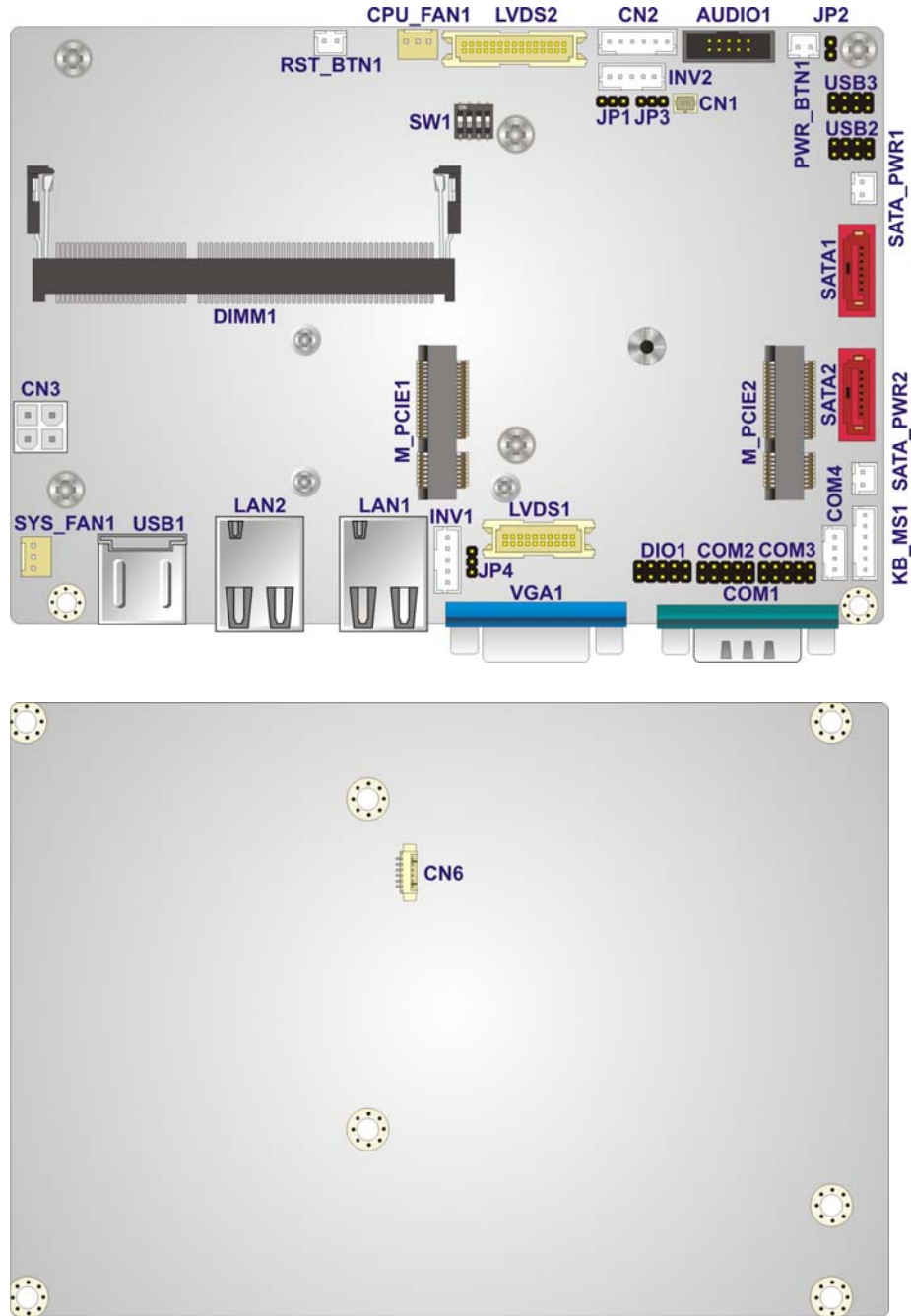

Figure 3-1: Connectors and Jumpers

### 3.1.2 Peripheral Interface Connectors

The table below lists all the connectors on the board.

Connector	Type	Label
5 V SATA power connectors	2-pin wafer	SATA_PWR1, SATA_PWR2
12 V power connector	4-pin Molex power connector	CN3
Audio connector	10-pin box header	AUDIO1
Backlight inverter connectors	5-pin wafer	INV1, INV2
Battery connector	2-pin wafer	CN1
Digital Input/Output (DIO) connector	10-pin header	DIO1
Fan connectors	3-pin wafer	CPU_FAN1, SYS_FAN2
Keyboard and mouse connector	6-pin wafer	KB_MS1
LVDS connectors	20-pin/30-pin crimp	LVDS1, LVDS2
LVDS2 backlight control connector	6-pin wafer	CN6
PCIe Mini card slots	52-pin PCIe Mini	M_PCIE1, M_PCIE2
Power & HDD LED connector	6-pin header	CN2
Power button connector	2-pin wafer	PWR_BTN1
Reset button connector	2-pin wafer	RST_BTN1
RS-232 serial port connectors	10-pin header	COM2, COM3
RS-422/485 serial port connector	4-pin wafer	COM4
Serial ATA (SATA) drive connectors	7-pin SATA	SATA1, SATA2
USB 2.0 connectors	8-pin header	USB2, USB3

**Table 3-1: Peripheral Interface Connectors**

### 3.1.3 External Interface Panel Connectors

The table below lists the connectors on the external I/O panel.

Connector	Type	Label
Dual USB port	Dual USB port	USB1
Ethernet connectors	RJ-45	LAN1, LAN2
RS-232 serial port connector	Male DB-9	COM1
VGA connector	15-pin female	VGA1

**Table 3-2: Rear Panel Connectors**

## 3.2 Internal Peripheral Connectors

The section describes all of the connectors on the WAFER-CV-D25501/N26001.

### 3.2.1 5 V SATA Power Connectors

**CN Label:** SATA\_PWR1, SATA\_PWR2

**CN Type:** 2-pin wafer

**CN Location:** See Figure 3-2

**CN Pinouts:** See Table 3-3

Use the 5 V SATA power connectors to connect to SATA device power connection.

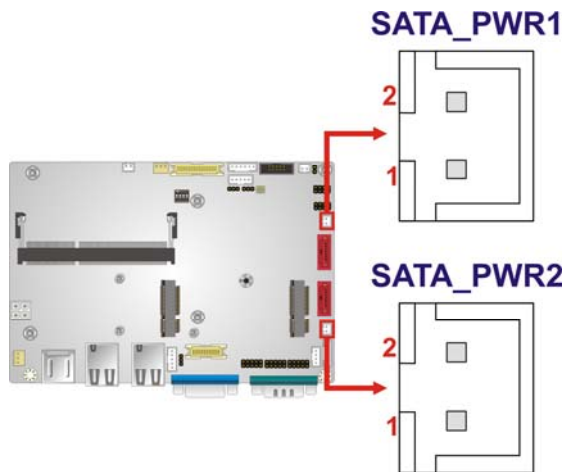

**Figure 3-2: 5 V SATA Power Connector Locations**

## WAFER-CV-D25501/N26001 3.5" Motherboard

Pin No.	Description
1	+5V
2	Ground

**Table 3-3: 5 V SATA Power Connector Pinouts**

### 3.2.2 12 V Power Connector

- CN Label:** CN3
- CN Type:** 4-pin Molex power connector
- CN Location:** See **Figure 3-3**
- CN Pinouts:** See **Table 3-4**

The ATX power connector connects to an ATX power supply.

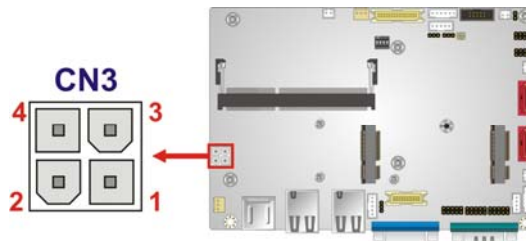

**Figure 3-3: 12 V Power Connector Location**

Pin	Description
1	GND
2	GND
3	+12V
4	+12V

**Table 3-4: 12 V Power Connector Pinouts**

### 3.2.3 Audio Connector

- CN Label:** AUDIO1
- CN Type:** 10-pin box header
- CN Location:** See **Figure 3-4**
- CN Pinouts:** See **Table 3-5**



The 10-pin audio connector is connected to external audio devices including speakers and microphones for the input and output of audio signals to and from the system.

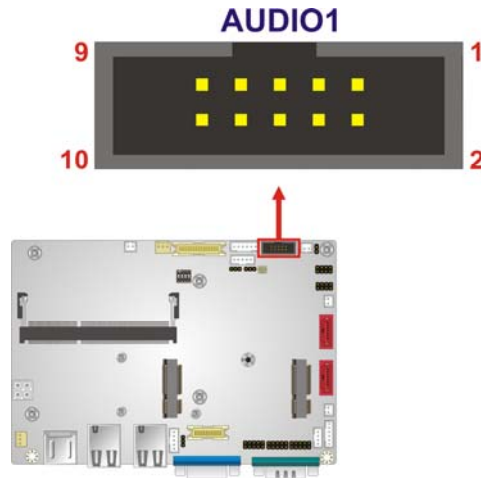

**Figure 3-4: Audio Connector Location**

Pin	Description	Pin	Description
1	Line-out_R	2	Line-in_R
3	AUD_GND	4	AUD_GND
5	Line-out_L	6	Line-in_L
7	AUD_GND	8	AUD_GND
9	MIC1_R	10	MIC1_L

**Table 3-5: Audio Connector Pinouts**

### 3.2.4 Backlight Inverter Connectors

- CN Label:** INV1, INV2
- CN Type:** 5-pin wafer
- CN Location:** See **Figure 3-5**
- CN Pinouts:** See **Table 3-6**

The backlight inverter connectors provide the backlights on the LCD display connected to the WAFER-CV-D25501/N26001 with +12V of power.

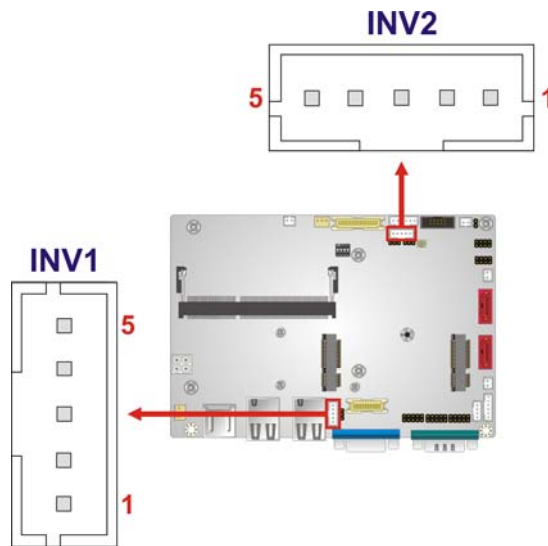

Figure 3-5: Backlight Inverter Connector Locations

Pin	Description
1	LCD_BKLTCTL
2	GROUND
3	+12V
4	GROUND
5	LCD_BKLEN

Table 3-6: Backlight Inverter Connector Pinouts

### 3.2.5 Battery Connector



**CAUTION:**

Risk of explosion if battery is replaced by an incorrect type. Only certified engineers should replace the on-board battery.

Dispose of used batteries according to instructions and local regulations.

**CN Label:** CN1

**CN Type:** 2-pin wafer

**CN Location:** See **Figure 3-6**

**CN Pinouts:** See **Table 3-7**

This is connected to the system battery. The battery provides power to the system clock to retain the time when power is turned off.

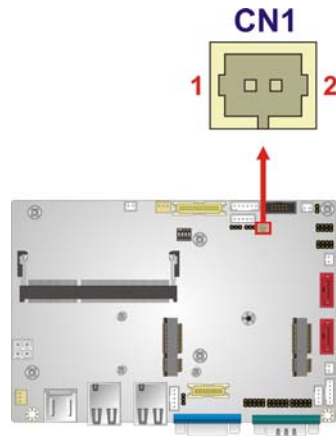

**Figure 3-6: Battery Connector Location**

Pin	Description
1	Battery+
2	GND

**Table 3-7: Battery Connector Pinouts**

### 3.2.6 Digital Input/Output (DIO) Connector

**CN Label:** DIO1

**CN Type:** 10-pin header

**CN Location:** See **Figure 3-7**

**CN Pinouts:** See **Table 3-8**

The digital input/output connector is managed through a Super I/O chip. The DIO connector pins are user programmable.

## WAFER-CV-D25501/N26001 3.5" Motherboard

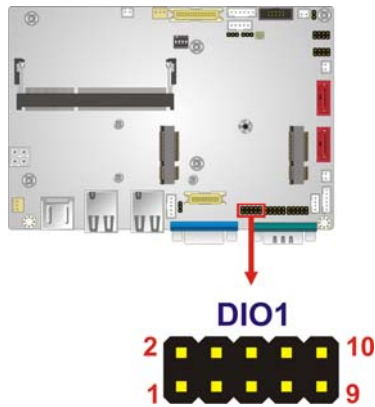

**Figure 3-7: Digital I/O Connector Location**

Pin	Description	Pin	Description
1	GND	2	VCC
3	Output 3	4	Output 2
5	Output 1	6	Output 0
7	Input 3	8	Input 2
9	Input 1	10	Input 0

**Table 3-8: Digital I/O Connector Pinouts**

### 3.2.7 Fan Connectors

**CN Label:** CPU\_FAN1, SYS\_FAN1

**CN Type:** 3-pin wafer

**CN Location:** See **Figure 3-8**

**CN Pinouts:** See **Table 3-9**

The fan connectors attach to the CPU/system cooling fans.

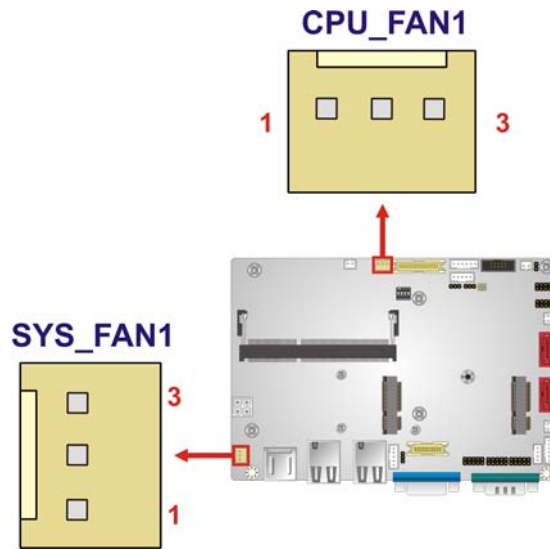

**Figure 3-8: Fan Connector Locations**

PIN NO.	DESCRIPTION
1	GND
2	+12 V
3	Fan Speed Detect

**Table 3-9: Fan Connector Pinouts**

### 3.2.8 Keyboard/Mouse Connector

- CN Label:** KB\_MS1
- CN Type:** 6-pin wafer
- CN Location:** See **Figure 3-9**
- CN Pinouts:** See **Table 3-10**

The keyboard and mouse connector can be connected to a standard PS/2 cable or PS/2 Y-cable to add keyboard and mouse functionality to the system.

## WAFER-CV-D25501/N26001 3.5" Motherboard

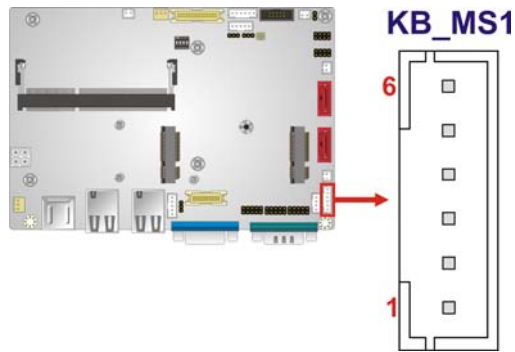

**Figure 3-9: Keyboard/Mouse Connector Location**

Pin	Description
1	+5 V KB DATA
2	MS DATA
3	MS CLK
4	KB DATA
5	KB CLK
6	GROUND

**Table 3-10: Keyboard/Mouse Connector Pinouts**

### 3.2.9 LVDS1 Connector

- CN Label:** LVDS1
- CN Type:** 20-pin crimp
- CN Location:** See **Figure 3-10**
- CN Pinouts:** See **Table 3-11**

The 20-pin LVDS LCD connector can be connected to an 18-bit/24-bit single-channel LVDS panel.

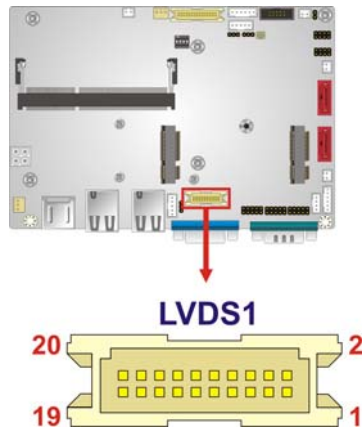
**Figure 3-10: LVDS1 Connector Location**

Pin	Description	Pin	Description
1	GND	2	GND
3	LVDS_DATA0	4	LVDS_DATA0#
5	LVDS_DATA1	6	LVDS_DATA1#
7	LVDS_DATA2	8	LVDS_DATA2#
9	LVDS_CLK	10	LVDS_CLK#
11	LVDS_DATA3	12	LVDS_DATA3#
13	GND	14	GND
15	LDDC_DATA	16	LDDC_CLK
17	VCC_LCD	18	VCC_LCD
19	VCC_LCD	20	VCC_LCD

**Table 3-11: LVDS1 Connector Pinouts**

### 3.2.10 LVDS2 Connector

- CN Label:** LVDS2
- CN Type:** 30-pin crimp
- CN Location:** See **Figure 3-11**
- CN Pinouts:** See **Table 3-12**

The 30-pin LVDS LCD connector can be connected to a 24-bit dual-channel LVDS panel.

# WAFER-CV-D25501/N26001 3.5" Motherboard

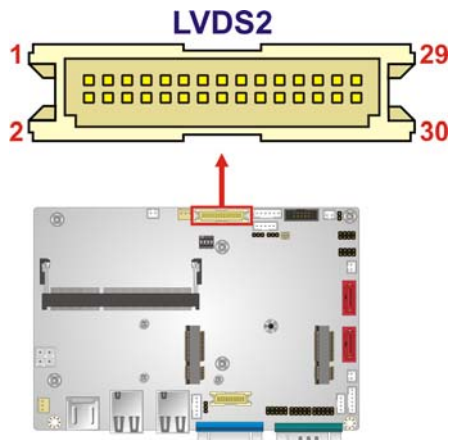

**Figure 3-11: LVDS2 Connector Location**

Pin	Description	Pin	Description
1	GND	2	GND
3	LVDS_DATA0	4	LVDS_DATA0#
5	LVDS_DATA1	6	LVDS_DATA1#
7	LVDS_DATA2	8	LVDS_DATA2#
9	LVDS_CLK1	10	LVDS_CLK1#
11	LVDS_DATA3	12	LVDS_DATA3#
13	GND	14	GND
15	LVDS_DATA4	16	LVDS_DATA4#
17	LVDS_DATA5	18	LVDS_DATA5#
19	LVDS_DATA6	20	LVDS_DATA6#
21	LVDS_CLK2	22	LVDS_CLK2#
23	LVDS_DATA7	24	LVDS_DATA7#
25	GND	26	GND
27	VCC_LCD	28	VCC_LCD
29	VCC_LCD	30	VCC_LCD

**Table 3-12: LVDS2 Connector Pinouts**



### 3.2.11 LVDS2 Backlight Control Connector

- CN Label:** CN6
- CN Type:** 6-pin wafer
- CN Location:** See **Figure 3-12**
- CN Pinouts:** See **Table 3-13**

This connector allows control of the LVDS2 panel backlight.

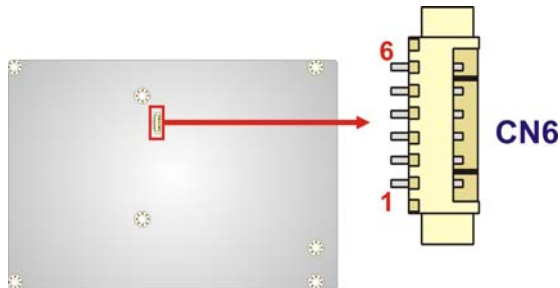

**Figure 3-12: LVDS2 Backlight Control Connector Location**

Function	Pin	Description
Panel power button	1	PWRDN
	2	GND
Panel brightness +	3	BLUP
	4	GND
Panel brightness -	5	BLDN
	6	GND

**Table 3-13: LVDS2 Backlight Control Connector Pinouts**

### 3.2.12 PCIe Mini Card Slots

- CN Label:** M\_PCIE1, M\_PCIE2
- CN Type:** 52-pin PCIe Mini card slot
- CN Location:** See **Figure 3-13**
- CN Pinouts:** See **Table 3-14**

The **M\_PCIE2** slot can be connected to a full-size PCIe Mini card while the **M\_PCIE1** slot can be connected to a half-size PCIe Mini card.

# WAFER-CV-D25501/N26001 3.5" Motherboard



## NOTE:

The **M\_PCIE2** slot supports mSATA devices.

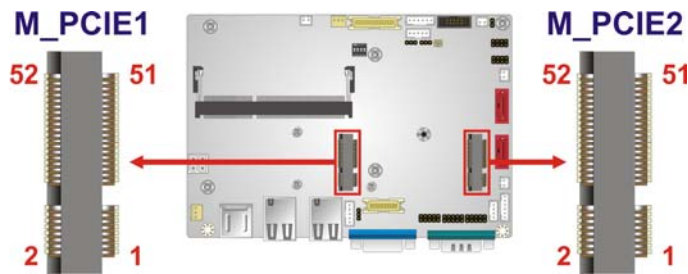

**Figure 3-13: PCIe Mini Card Slot Locations**

Pin	Description	Pin	Description
1	PCIE_WAKE#	2	VCC3
3	N/C	4	GND
5	N/C	6	1.5V
7	N/C	8	N/C
9	GND	10	N/C
11	PCIE_CLK#	12	N/C
13	PCIE_CLK	14	N/C
15	GND	16	N/C
17	N/C	18	GND
19	N/C	20	N/C
21	GND	22	PCIRST#
23	PCIE_RXN	24	VCC3
25	PCIE_RXP	26	GND
27	GND	28	1.5V
29	GND	30	SMBCLK
31	PCIE_TXN	32	SMBDATA
33	PCIE_TXP	34	GND
35	GND	36	USBD-

Pin	Description	Pin	Description
37	GND	38	USBD+
39	VCC3	40	GND
41	VCC3	42	N/C
43	GND	44	N/C
45	N/C	46	N/C
47	N/C	48	1.5V
49	N/C	50	GND
51	N/C	52	VCC3

**Table 3-14: PCIe Mini Card Slot Pinouts**

### 3.2.13 Power & HDD LED Connector

- CN Label:** CN2
- CN Type:** 6-pin wafer
- CN Location:** See **Figure 3-14**
- CN Pinouts:** See **Table 3-15**

The LED connector connects to an HDD indicator LED and a power LED on the system chassis to inform the user about HDD activity and the power on/off status of the system.

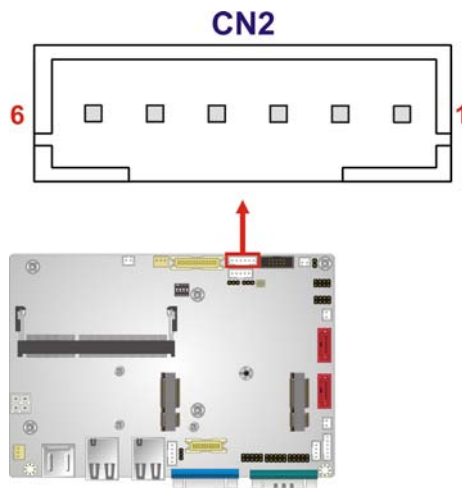

**Figure 3-14: Power & HDD LED Connector Location**

## WAFER-CV-D25501/N26001 3.5" Motherboard

Pin	Description
1	+5V
2	GND
3	Power LED+
4	Power LED-
5	HDD LED+
6	HDD LED-

**Table 3-15: Power & HDD LED Connector Pinouts**

### 3.2.14 Power Button Connector

**CN Label:** PWR\_BTN1

**CN Type:** 2-pin wafer

**CN Location:** See **Figure 3-15**

**CN Pinouts:** See **Table 3-16**

The power button connector is connected to a power switch on the system chassis to enable users to turn the system on and off.

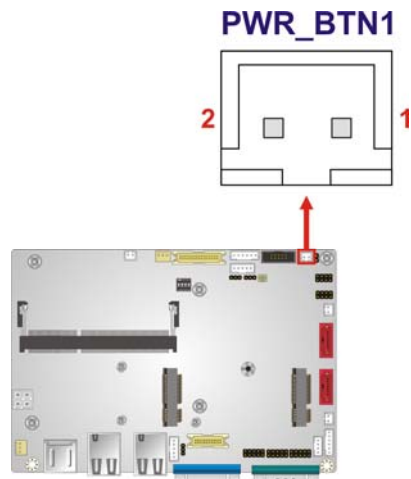

**Figure 3-15: Power Button Connector Location**

Pin	Description
1	PWR_BTN+
2	PWR_BTN-

**Table 3-16: Power Button Connector Pinouts**

### 3.2.15 Reset Button Connector

- CN Label:** RST\_BTN1
- CN Type:** 2-pin wafer
- CN Location:** See **Figure 3-16**
- CN Pinouts:** See **Table 3-17**

The reset button connector is connected to a reset switch on the system chassis to enable users to reboot the system when the system is turned on.

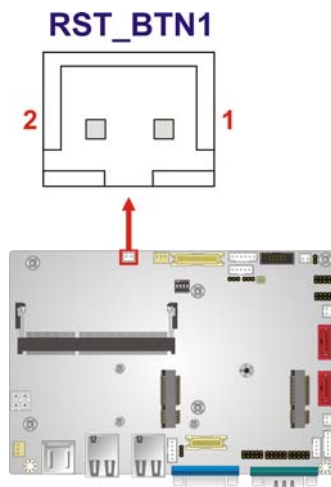

**Figure 3-16: Reset Button Connector Location**

Pin	Description
1	RESET+
2	RESET-

**Table 3-17: Reset Button Connector Pinouts**

### 3.2.16 RS-232 Serial Port Connectors

- CN Label:** COM2, COM3
- CN Type:** 10-pin header
- CN Location:** See **Figure 3-17**
- CN Pinouts:** See **Table 3-18**

Each of these connectors provides RS-232 connections.

## WAFER-CV-D25501/N26001 3.5" Motherboard

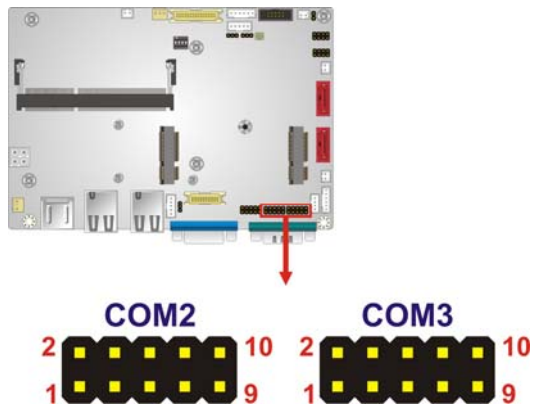

Figure 3-17: RS-232 Serial Port Connector Locations

Pin	Description	Pin	Description
1	DCD	2	DSR
3	RXD	4	RTS
5	TXD	6	CTS
7	DTR	8	RI
9	GND	10	GND

Table 3-18: RS-232 Serial Port Connector Pinouts

### 3.2.17 RS-422/485 Serial Port Connector

**CN Label:** COM4  
**CN Type:** 4-pin wafer  
**CN Location:** See Figure 3-18  
**CN Pinouts:** See Table 3-19



#### NOTE:

These pins are shared with those on the main serial port. Use either the pins on the main connector, or on this connector, but not both.

This connector provides RS-422 or RS-485 communications.

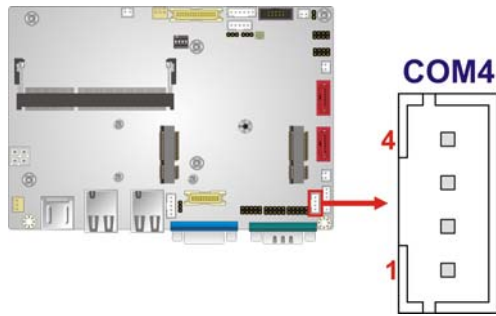

**Figure 3-18: RS-422/485 Connector Location**

Pin	Description	Pin	Description
1	RXD422-	3	TXD422+/TXD485+
2	RXD422+	4	TXD422-/TXD485-

**Table 3-19: RS-422/485 Connector Pinouts**

### 3.2.18 SATA Drive Connectors

- CN Label:** SATA1, SATA2
- CN Type:** 7-pin SATA drive connector
- CN Location:** See Figure 3-19
- CN Pinouts:** See Table 3-20

The SATA drive connectors can be connected to SATA drives and support up to 3Gb/s data transfer rate.

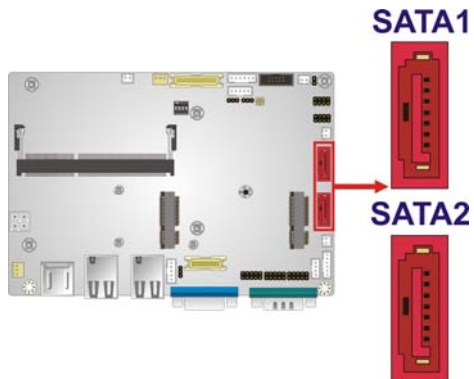

**Figure 3-19: SATA Drive Connector Locations**

## WAFER-CV-D25501/N26001 3.5" Motherboard

Pin	Description
1	GND
2	TX+
3	TX-
4	GND
5	RX-
6	RX+
7	GND

Table 3-20: SATA Drive Connector Pinouts

### 3.2.19 USB Connectors

**CN Label:** USB2, USB3

**CN Type:** 8-pin header

**CN Location:** See Figure 3-20

**CN Pinouts:** See Table 3-21

Each USB connector provides connectivity to two USB 1.1/2.0 ports.

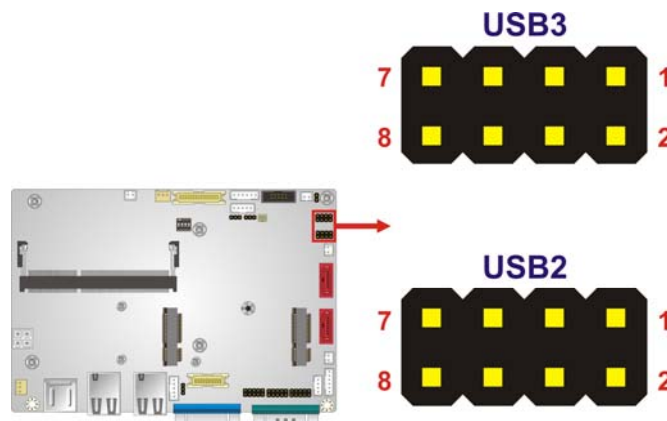

Figure 3-20: USB Connector Locations

Pin	Description	Pin	Description
1	USB_VCC	2	GND
3	DATA-	4	DATA+
5	DATA+	6	DATA-



Pin	Description	Pin	Description
7	GND	8	USB_VCC

**Table 3-21: USB Connector Pinouts**

### 3.3 External Peripheral Interface Connector Panel

The figure below shows the external peripheral interface connector (EPIC) panel. The EPIC panel consists of the following:

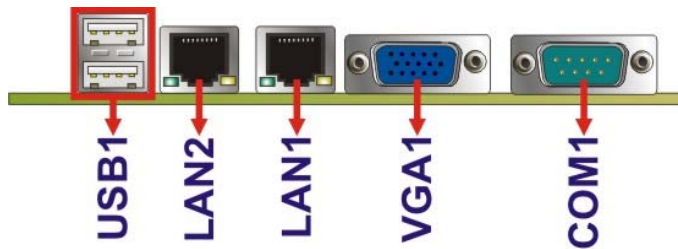
**Figure 3-21: External Peripheral Interface Connector**

#### 3.3.1 Ethernet Connectors

- CN Label:** LAN1, LAN2
- CN Type:** RJ-45 connector
- CN Location:** See **Figure 3-21**
- CN Pinouts:** See **Table 3-22**

The WAFER-CV-D25501/N26001 is equipped with two built-in RJ-45 Ethernet controllers. Each controller can connect to the LAN through one RJ-45 LAN connector.

Pin	Description	Pin	Description
1	LAN1_MDIO+	5	LAN1_MDI2+
2	LAN1_MDIO-	6	LAN1_MDI2-
3	LAN1_MDI1+	7	LAN1_MDI3+
4	LAN1_MDI1-	8	LAN1_MDI3-

**Table 3-22: LAN Pinouts**

## WAFER-CV-D25501/N26001 3.5" Motherboard

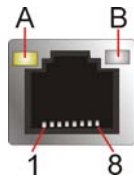

**Figure 3-22: RJ-45 Ethernet Connector**

LED	Description	LED	Description
A	on: linked blinking: data is being sent/received	B	off: 10 Mb/s green: 100 Mb/s orange: 1000 Mb/s

**Table 3-23: RJ-45 Ethernet Connector LEDs**

### 3.3.2 Serial Port Connector (COM1)

- CN Label:** COM1
- CN Type:** Male DB-9 connector
- CN Location:** See **Figure 3-21**
- CN Pinouts:** See **Table 3-24** and **Figure 3-23**

The serial port connects to a RS-232 serial communications device.

Pin	Description	Pin	Description
1	DATA CARRIER DETECT (DCD)	6	DATA SET READY (DSR)
2	RECEIVE DATA (RXD)	7	REQUEST TO SEND (RTS)
3	TRANSMIT DATA (TXD)	8	CLEAR TO SEND (CTS)
4	DATA TERMINAL READY (DTR)	9	RING INDICATOR (RI)
5	GND		

**Table 3-24: RS-232 Serial Port (COM 1) Pinouts**

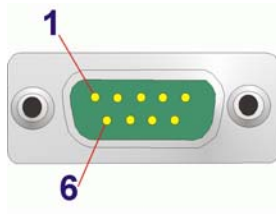

**Figure 3-23: COM1 Pinout Locations**

### 3.3.3 USB Connectors

- CN Label:** USB1
- CN Type:** Dual USB port
- CN Location:** See **Figure 3-21**
- CN Pinouts:** See **Table 3-25**

The ports connect to both USB 2.0 and USB 1.1 devices.

Pin	Description	Pin	Description
1	USB_VCC	2	USB_VCC
3	DATA-	4	DATA-
5	DATA+	6	DATA+
7	GND	8	GND

**Table 3-25: USB Port Pinouts**

### 3.3.4 VGA Connector

- CN Label:** VGA1
- CN Type:** 15-pin Female
- CN Location:** See **Figure 3-21**
- CN Pinouts:** See **Figure 3-24** and **Table 3-26**

The VGA connector connects to a monitor that accepts a standard VGA input.

## WAFER-CV-D25501/N26001 3.5" Motherboard

Pin	Description	Pin	Description
1	RED	2	GREEN
3	BLUE	4	NC
5	GND	6	GND
7	GND	8	GND
9	VGA VCC	10	GND
11	NC	12	DDCDAT
13	HSYNC	14	VSYNC
15	DDCCLK		

**Table 3-26: VGA Connector Pinouts**

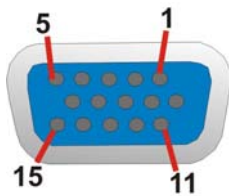

**Figure 3-24: VGA Connector**



**NOTE:**

Due to Intel® GMA driver limitation, the monitor connected to the VGA connector may become extended desktop or not have signal to it after restarting from the graphics driver installation. To work out this limitation, press the Ctrl+Alt+F1 hotkey to switch the primary display to CRT mode.



Chapter

4

# Installation

---

## WAFER-CV-D25501/N26001 3.5" Motherboard

### 4.1 Anti-static Precautions

---



#### **WARNING:**

Failure to take ESD precautions during the installation of the WAFER-CV-D25501/N26001 may result in permanent damage to the WAFER-CV-D25501/N26001 and severe injury to the user.

---

Electrostatic discharge (ESD) can cause serious damage to electronic components, including the WAFER-CV-D25501/N26001. Dry climates are especially susceptible to ESD. It is therefore critical that whenever the WAFER-CV-D25501/N26001 or any other electrical component is handled, the following anti-static precautions are strictly adhered to.

- ***Wear an anti-static wristband:*** - Wearing a simple anti-static wristband can help to prevent ESD from damaging the board.
- ***Self-grounding:***- Before handling the board touch any grounded conducting material. During the time the board is handled, frequently touch any conducting materials that are connected to the ground.
- ***Use an anti-static pad:*** When configuring the WAFER-CV-D25501/N26001, place it on an antic-static pad. This reduces the possibility of ESD damaging the WAFER-CV-D25501/N26001.
- ***Only handle the edges of the PCB:-:*** When handling the PCB, hold the PCB by the edges.

### 4.2 Installation Considerations

---



#### **NOTE:**

The following installation notices and installation considerations should be read and understood before installation. All installation notices must be strictly adhered to. Failing to adhere to these precautions may lead to severe damage and injury to the person performing the installation.

---

**WARNING:**

The installation instructions described in this manual should be carefully followed in order to prevent damage to the components and injury to the user.

Before and during the installation please **DO** the following:

- Read the user manual:
  - The user manual provides a complete description of the WAFER-CV-D25501/N26001 installation instructions and configuration options.
- Wear an electrostatic discharge cuff (ESD):
  - Electronic components are easily damaged by ESD. Wearing an ESD cuff removes ESD from the body and helps prevent ESD damage.
- Place the WAFER-CV-D25501/N26001 on an antistatic pad:
  - When installing or configuring the motherboard, place it on an antistatic pad. This helps to prevent potential ESD damage.
- Turn all power to the WAFER-CV-D25501/N26001 off:
  - When working with the WAFER-CV-D25501/N26001, make sure that it is disconnected from all power supplies and that no electricity is being fed into the system.

Before and during the installation of the WAFER-CV-D25501/N26001 **DO NOT:**

- Remove any of the stickers on the PCB board. These stickers are required for warranty validation.
- Use the product before verifying all the cables and power connectors are properly connected.
- Allow screws to come in contact with the PCB circuit, connector pins, or its components.

## WAFER-CV-D25501/N26001 3.5" Motherboard

### 4.3 SO-DIMM Installation



#### WARNING:

Using incorrectly specified SO-DIMM may cause permanent damage to the WAFER-CV-D25501/N26001. Please make sure the purchased SO-DIMM complies with the memory specifications of the WAFER-CV-D25501/N26001. SO-DIMM specifications compliant with the WAFER-CV-D25501/N26001 are listed in Chapter 1.

To install a SO-DIMM into a SO-DIMM socket, please follow the steps below and refer to **Figure 4-1**.

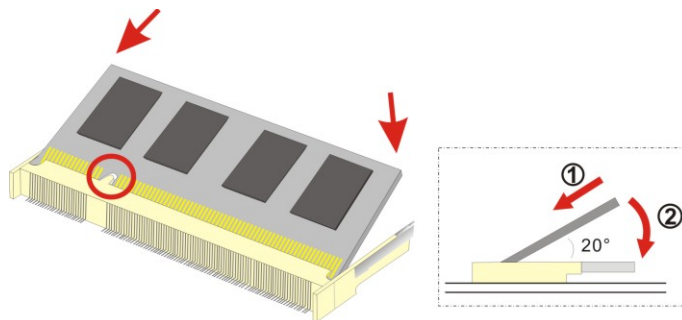

**Figure 4-1: SO-DIMM Installation**

- Step 1:** **Locate the SO-DIMM socket.** Place the WAFER-CV-D25501/N26001 on an anti-static pad with the solder side facing up.
- Step 2:** **Align the SO-DIMM with the socket.** The SO-DIMM must be oriented in such a way that the notch in the middle of the SO-DIMM must be aligned with the plastic bridge in the socket.
- Step 3:** **Insert the SO-DIMM.** Push the SO-DIMM chip into the socket at an angle. (See **Figure 4-1**)
- Step 4:** **Open the SO-DIMM socket arms.** Gently pull the arms of the SO-DIMM socket out and push the rear of the SO-DIMM down. (See **Figure 4-1**)



**Step 5: Secure the SO-DIMM.** Release the arms on the SO-DIMM socket. They clip into place and secure the SO-DIMM in the socket.

## 4.4 Jumper Settings



### NOTE:

A jumper is a metal bridge used to close an electrical circuit. It consists of two or three metal pins and a small metal clip (often protected by a plastic cover) that slides over the pins to connect them. To CLOSE/SHORT a jumper means connecting the pins of the jumper with the plastic clip and to OPEN a jumper means removing the plastic clip from a jumper.

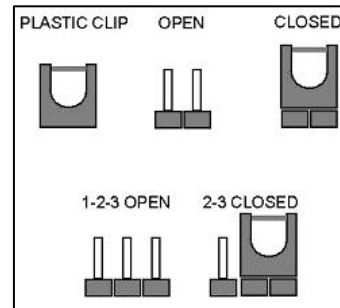

The hardware jumpers must be set before installation. Jumpers are shown in **Table 4-1**.

Description	Label	Type
AT/ATX power selection	JP2	2-pin header
Clear CMOS	JP3	3-pin header
LVDS1 voltage selection	JP4	3-pin header
LVDS2 voltage selection	JP1	3-pin header
LVDS2 panel type selection	SW1	4-pin switch

**Table 4-1: Jumpers**

### 4.4.1 AT/ATX Power Selection Jumper

**Jumper Label:** JP2  
**Jumper Type:** 2-pin header  
**Jumper Settings:** See **Table 4-2**  
**Jumper Location:** See **Figure 4-2**

## WAFER-CV-D25501/N26001 3.5" Motherboard

The AT/ATX power selection jumper specifies the system power mode as AT or ATX.

Setting	Description
Short 1-2	Use ATX power (Default)
Off	Use AT power

**Table 4-2: AT/ATX Power Selection Jumper Settings**

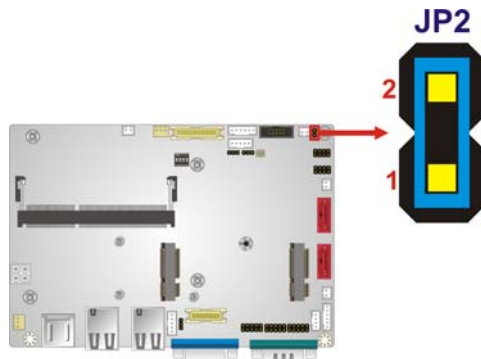

**Figure 4-2: AT/ATX Power Selection Jumper Location**

### 4.4.2 Clear CMOS Jumper

<b>Jumper Label:</b>	<b>JP3</b>
<b>Jumper Type:</b>	3-pin header
<b>Jumper Settings:</b>	See <b>Table 4-3</b>
<b>Jumper Location:</b>	See <b>Figure 4-3</b>

To reset the BIOS, move the jumper to the "Clear BIOS" position for 3 seconds or more, and then move back to the default position.

Setting	Description
Short 1-2	Normal
Short 2-3	Clear BIOS

**Table 4-3: Clear CMOS Jumper Settings**

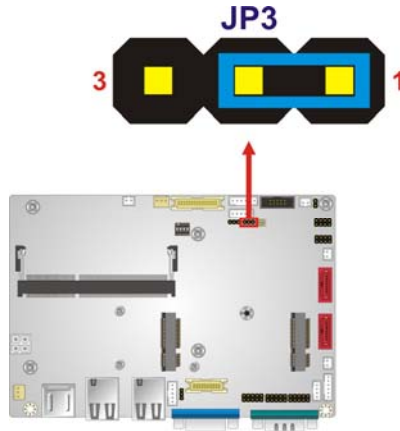

**Figure 4-3: Clear CMOS Jumper Location**

### 4.4.3 LVDS1 Voltage Selection



**WARNING:**

Permanent damage to the screen and WAFER-CV-D25501/N26001 may occur if the wrong voltage is selected with this jumper. Please refer to the user guide that came with the monitor to select the correct voltage.

- Jumper Label:** JP4
- Jumper Type:** 3-pin header
- Jumper Settings:** See Table 4-4
- Jumper Location:** See Figure 4-4

Sets the voltage provided to the monitor by LVDS1.

Setting	Description
Short 1-2	+3.3V LVDS (Default)
Short 2-3	+5V LVDS

**Table 4-4: LVDS1 Voltage Selection Jumper Settings**

## WAFER-CV-D25501/N26001 3.5" Motherboard

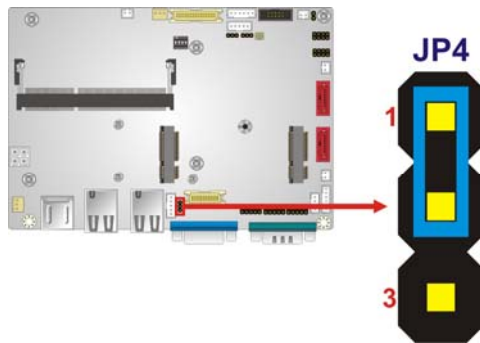

Figure 4-4: LVDS1 Voltage Selection Jumper Location

### 4.4.4 LVDS2 Voltage Selection



#### **WARNING:**

Permanent damage to the screen and WAFER-CV-D25501/N26001 may occur if the wrong voltage is selected with this jumper. Please refer to the user guide that came with the monitor to select the correct voltage.

<b>Jumper Label:</b>	<b>JP1</b>
<b>Jumper Type:</b>	3-pin header
<b>Jumper Settings:</b>	See <b>Table 4-5</b>
<b>Jumper Location:</b>	See <b>Figure 4-5</b>

Sets the voltage provided to the monitor connected to LVDS2.

Setting	Description
Short 1-2	+3.3V LVDS (Default)
Short 2-3	+5V LVDS

**Table 4-5: LVDS2 Voltage Selection Jumper Settings**

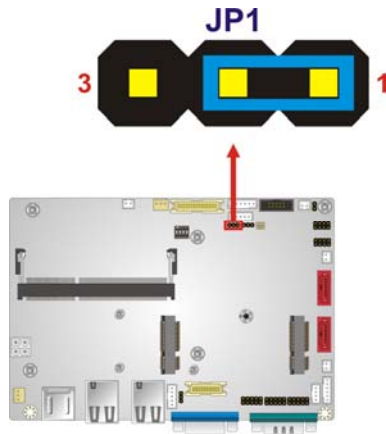

**Figure 4-5: LVDS2 Voltage Selection Jumper Location**

#### 4.4.5 LVDS2 Panel Type Selection Jumper

- Jumper Label:** SW1
- Jumper Type:** 4-pin switch
- Jumper Settings:** See Table 4-6
- Jumper Location:** See Figure 4-6

Sets the panel type of the LVDS2 video channel.

Pin No. 4321	EDID Resolution	Color Depth	Channel
0000	800 x 600 @ 60 Hz	18-bit	Single
0001	1024 x 768 @ 60Hz	18-bit	Single
0010	1024 x 768 @ 60Hz	24-bit	Single
0011	1280 x 768 @ 60Hz	18-bit	Single
0100	1280 x 800 @ 60Hz	18-bit	Single
0101	1280 x 960 @ 60Hz	18-bit	Single
0110	1280 x 1024 @ 60Hz	24-bit	Dual
0111	1366 x 768 @ 60Hz	18-bit	Single
1000	1366 x 768 @ 60Hz	24-bit	Single
1001	1440 x 900 @ 60Hz	24-bit	Dual
1010	1440 x 1050 @ 60Hz	24-bit	Dual
1011	1600 x 900 @ 60Hz	24-bit	Dual

## WAFER-CV-D25501/N26001 3.5" Motherboard

Pin No. 4321	EDID Resolution	Color Depth	Channel
1100	1680 x 1050 @ 60Hz	24-bit	Dual
1101	1600 x 1200 @ 60Hz	24-bit	Dual
1110	1920 x 1080 @ 60Hz	24-bit	Dual
1111	1920 x 1200 @ 60Hz	24-bit	Dual

**Table 4-6: LVDS2 Panel Resolution**

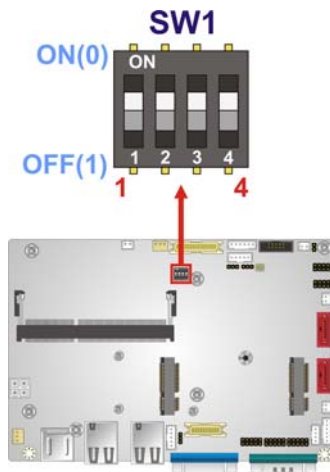

**Figure 4-6: LVDS2 Panel Type Selection Switch Location**

## 4.5 Chassis Installation

### 4.5.1 Airflow



#### **WARNING:**

Airflow is critical to the cooling of the CPU and other on-board components. The chassis in which the WAFER-CV-D25501/N26001 must have air vents to allow cool air to move into the system and hot air to move out.

The WAFER-CV-D25501/N26001 must be installed in a chassis with ventilation holes on the sides allowing airflow to travel through the heat sink surface. In a system with an

individual power supply unit, the cooling fan of a power supply can also help generate airflow through the board surface.

**NOTE:**

IEI has a wide range of chassis available. Please contact your WAFER-CV-D25501/N26001 vendor, reseller or an IEI sales representative at [sales@iei.com.tw](mailto:sales@iei.com.tw) or visit the IEI website (<http://www.ieworld.com.tw>) to find out more about the available chassis.

---

### 4.5.2 Motherboard Installation

To install the WAFER-CV-D25501/N26001 motherboard into the chassis please refer to the reference material that came with the chassis.

## 4.6 Internal Peripheral Device Connections

This section outlines the installation of peripheral devices to the on-board connectors.

### 4.6.1 Audio Kit Installation

The Audio Kit that came with the WAFER-CV-D25501/N26001 connects to the 10-pin audio connector on the WAFER-CV-D25501/N26001. The audio kit consists of three audio jacks. One audio jack, Mic In, connects to a microphone. The remaining two audio jacks, Line-In and Line-Out, connect to two speakers. To install the audio kit, please refer to the steps below:

**Step 1: Locate the audio connector.** The location of the 10-pin audio connector is shown in **Chapter 3**.

**Step 2: Align pin 1.** Align pin 1 on the on-board connector with pin 1 on the audio kit connector. Pin 1 on the audio kit connector is indicated with a white dot. See **Figure 4-7**.

## WAFER-CV-D25501/N26001 3.5" Motherboard

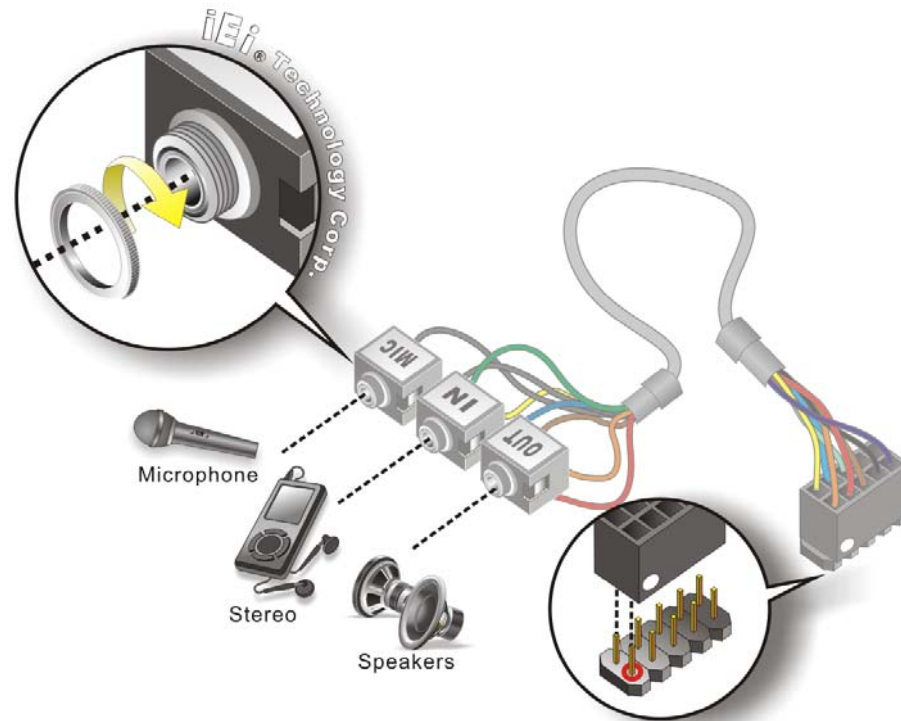

**Figure 4-7: Audio Kit Cable Connection**

**Step 3:** **Connect the audio devices.** Connect one speaker to the line-in audio jack, one speaker to the line-out audio jack and a microphone to the mic-in audio jack.

### 4.6.2 LVDS LCD Installation

The WAFER-CV-D25501/N26001 can be connected to a TFT LCD screen through the LVDS crimp connectors on the board. To connect a TFT LCD to the WAFER-CV-D25501/N26001, please follow the steps below.

**Step 1:** **Locate the connector.** The locations of the LVDS connectors are shown in **Chapter 3**.

**Step 2:** **Insert the cable connector.** Insert the connector from the LVDS PCB driving board to the LVDS connector as shown in **Figure 4-8**. When connecting the connectors, make sure the pins are properly aligned.



**WARNING:**

The diagram below is merely for illustration. The configuration and connection of the cables from the TFT LCD screen being installed may be different. Please refer to the installation manual that came with the TFT LCD screen.

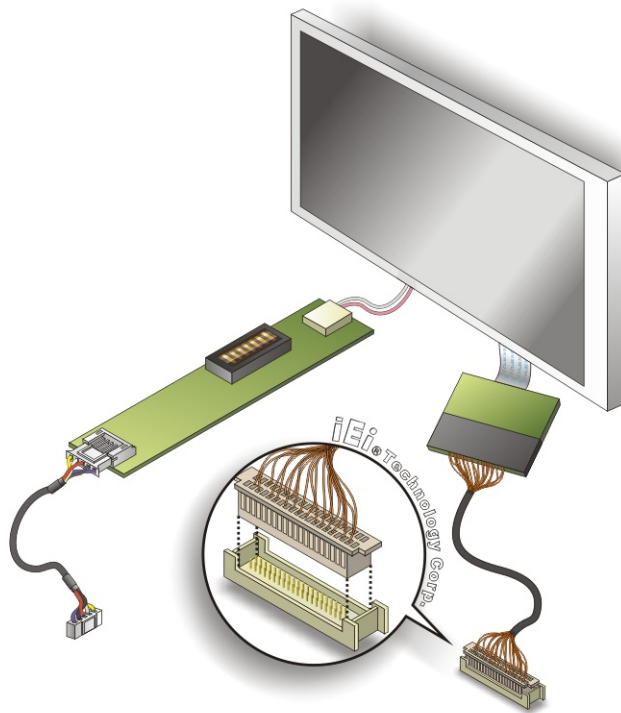

**Figure 4-8: LVDS Connector**

**Step 3:** **Locate the backlight inverter connector.** The locations of the backlight inverter connectors are shown in **Chapter 3**.

**Step 4:** **Connect backlight connector.** Connect the backlight connector to the driver TFT LCD PCB as shown in **Figure 4-9**. When inserting the cable connector, make sure the pins are properly aligned.

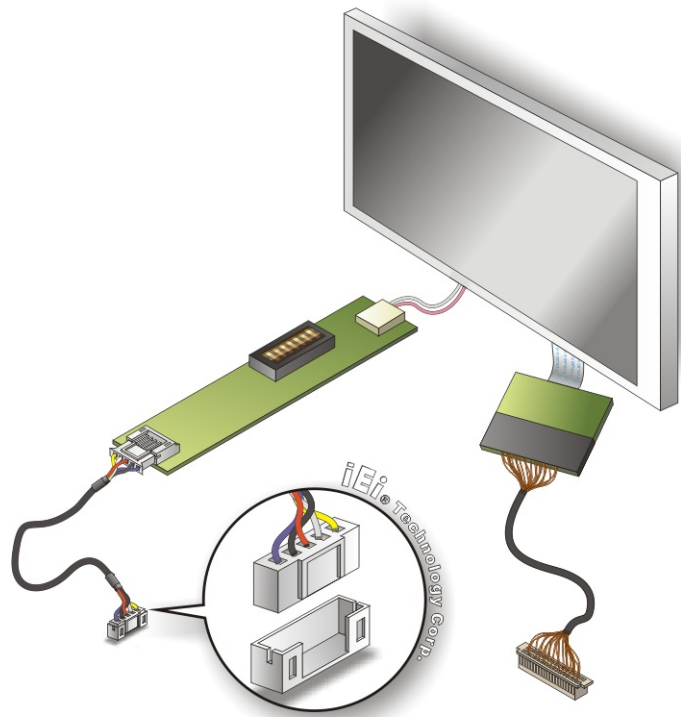
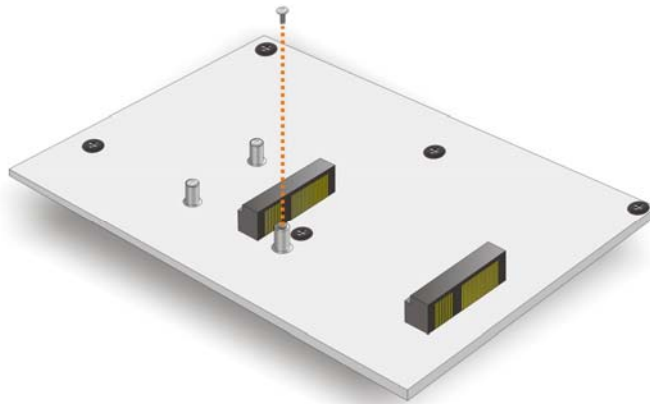

Figure 4-9: Backlight Inverter Connection

### 4.6.3 Full-size PCIe Mini Card Installation

To install a full-size PCIe Mini card, please follow the steps below.

- Step 1:** Locate the full-size PCIe Mini card slot. The location of the full-size PCIe Mini card slot is shown in **Chapter 3**.
- Step 2:** Remove the retention screw. Remove the retention screw secured on the motherboard as shown in **Figure 4-10**.



**Figure 4-10: Remove the Retention Screw for the Full-size PCIe Mini Card**

**Step 3:** Insert into the socket at an angle. Line up the notch on the card with the notch on the connector. Slide the PCIe Mini card into the socket at an angle of about 20° (Figure 4-11).

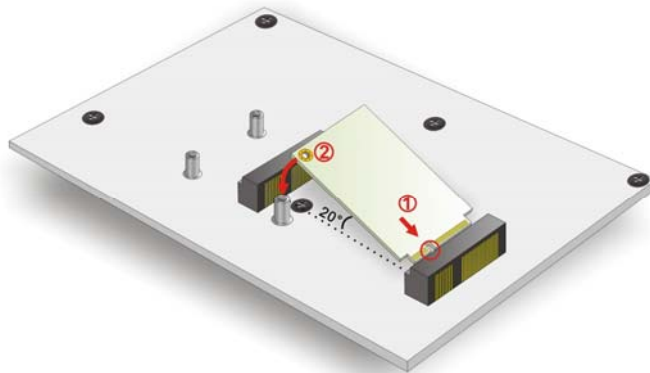

**Figure 4-11: Insert the Full-size PCIe Mini Card into the Socket at an Angle**

**Step 4:** Secure the full-size PCIe Mini card. Secure the full-size PCIe Mini card with the retention screw previously removed (Figure 4-12).

## WAFER-CV-D25501/N26001 3.5" Motherboard

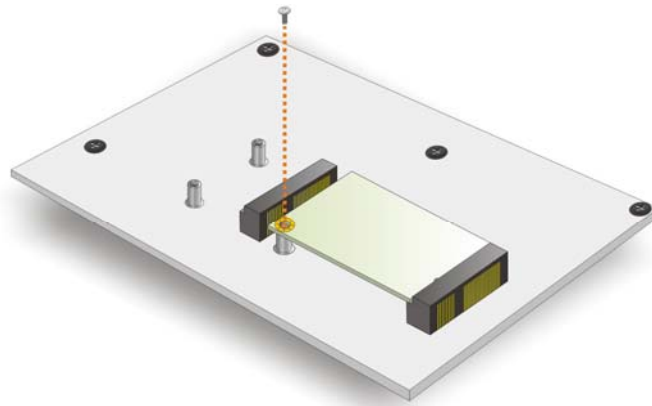

Figure 4-12: Secure the Full-size PCIe Mini Card

#### 4.6.4 Half-size PCIe Mini Card Installation

To install a half-size PCIe Mini card, please follow the steps below.

**Step 1:** Locate the half-size PCIe Mini card slot. The location of the half-size PCIe Mini card slot is shown in **Chapter 3**.

**Step 2:** Remove the retention screws. Remove the two retention screws secured on the motherboard as shown in **Figure 4-13**.

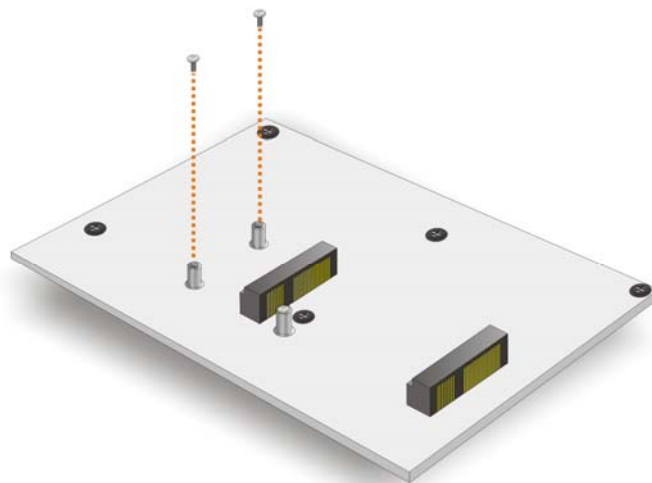

Figure 4-13: Remove the Retention Screws for the Half-size PCIe Mini Card

**Step 3:** Insert into the socket at an angle. Line up the notch on the card with the notch on the connector. Slide the PCIe Mini card into the socket at an angle of about 20° (Figure 4-14).

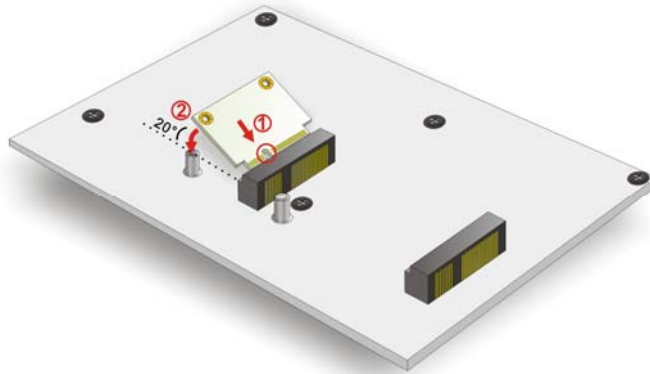

Figure 4-14: Insert the Half-size PCIe Mini Card into the Socket at an Angle

**Step 4:** Secure the half-size PCIe Mini card. Secure the half-size PCIe Mini card with the two retention screws previously removed (Figure 4-15).

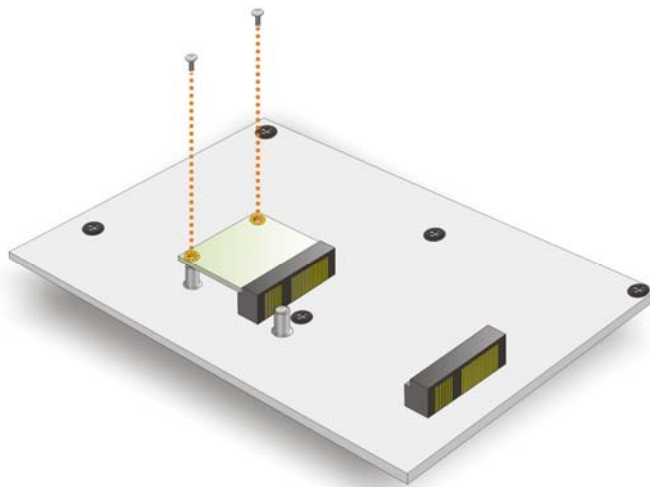

Figure 4-15: Secure the Half-size PCIe Mini Card

#### 4.6.5 SATA Drive Connection

The WAFER-CV-D25501/N26001 is shipped with a SATA drive cable. To connect the SATA drive to the connector, please follow the steps below.

## WAFER-CV-D25501/N26001 3.5" Motherboard

**Step 1:** Locate the SATA connector and the SATA power connector. The locations of the connectors are shown in **Chapter 3**.

**Step 2:** Insert the cable connector. Insert the cable connector into the on-board SATA drive connector and the SATA power connector. See **Figure 4-16**.

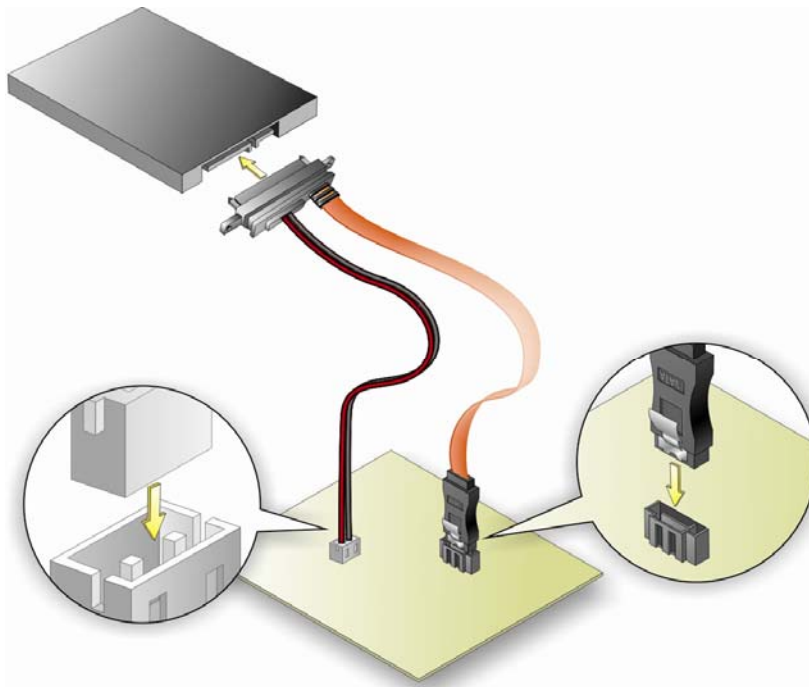

**Figure 4-16: SATA Drive Cable Connection**

**Step 3:** Connect the cable to the SATA disk. Connect the connector on the other end of the cable to the connector at the back of the SATA drive. See **Figure 4-16**.

**Step 4:** To remove the SATA cable from the SATA connector, press the clip on the connector at the end of the cable.

### 4.6.6 Single RS-232 Cable

The single RS-232 cable consists of one serial port connector attached to a serial communications cable that is then attached to a D-sub 9 male connector. To install the single RS-232 cable, please follow the steps below.

**Step 1:** **Locate the connector.** The locations of the RS-232 connectors are shown in **Chapter 3.**

**Step 2:** **Insert the cable connector.** Insert the connector into the serial port header. See **Figure 4-17.** A key on the front of the cable connector ensures the connector can only be installed in one direction.

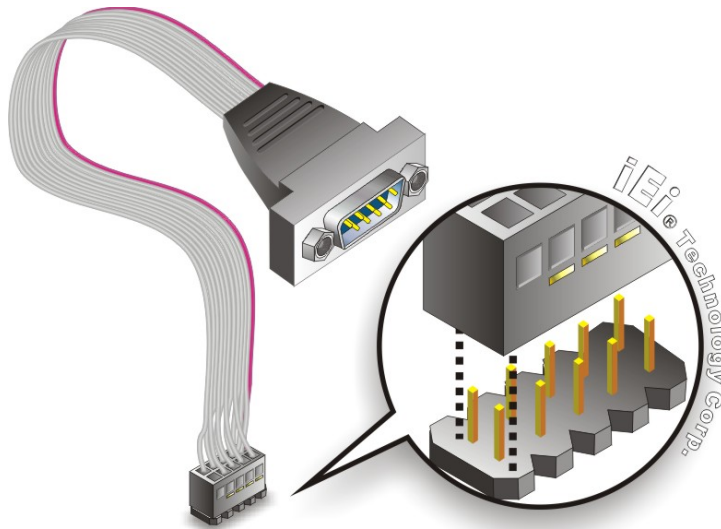

**Figure 4-17: Single RS-232 Cable Installation**

**Step 3:** **Secure the bracket.** The single RS-232 connector has two retention screws that must be secured to a chassis or bracket.

**Step 4:** **Connect the serial device.** Once the single RS-232 connector is connected to a chassis or bracket, a serial communications device can be connected to the system.

#### 4.6.7 Keyboard/Mouse Y-cable Connector

The WAFER-CV-D25501/N26001 is shipped with a keyboard/mouse Y-cable connector. The keyboard/mouse Y-cable connector connects to a keyboard/mouse connector on the WAFER-CV-D25501/N26001 and branches into two cables that are each connected to a PS/2 connector, one for a mouse and one for a keyboard. To connect the keyboard/mouse Y-cable connector, please follow the steps below.

## WAFER-CV-D25501/N26001 3.5" Motherboard

- Step 1: Locate the connector.** The location of the keyboard/mouse Y-cable connector is shown in **Chapter 3**.
- Step 2: Align the connectors.** Correctly align pin 1 on the cable connector with pin 1 on the WAFER-CV-D25501/N26001 keyboard/mouse connector. See **Figure 4-18**.
- Step 3: Insert the cable connectors** Once the cable connector is properly aligned with the keyboard/mouse connector on the WAFER-CV-D25501/N26001, connect the cable connector to the on-board connector. See **Figure 4-18**.

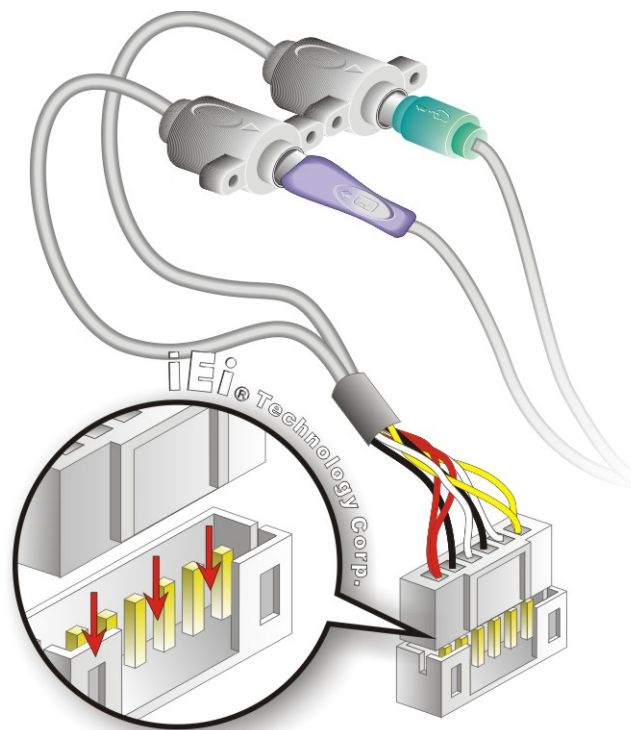

**Figure 4-18: Keyboard/mouse Y-cable Connection**

- Step 4: Attach PS/2 connectors to the chassis.** The keyboard/mouse Y-cable connector is connected to two PS/2 connectors. To secure the PS/2 connectors to the chassis please refer to the installation instructions that came with the chassis.
- Step 5: Connect the keyboard and mouse.** Once the PS/2 connectors are connected to the chassis, a keyboard and mouse can each be connected to one of the



PS/2 connectors. The keyboard PS/2 connector and mouse PS/2 connector are both marked. Please make sure the keyboard and mouse are connected to the correct PS/2 connector.

## 4.7 External Peripheral Interface Connection

This section describes connecting devices to the external connectors on the WAFER-CV-D25501/N26001.

### 4.7.1 LAN Connection

The RJ-45 connector enables connection to an external network. To connect a LAN cable with an RJ-45 connector, please follow the instructions below.

**Step 1:** **Locate the RJ-45 connector.** The locations of the RJ-45 connectors are shown in **Chapter 3**.

**Step 2:** **Align the connectors.** Align the RJ-45 connector on the LAN cable with the RJ-45 connector on the WAFER-CV-D25501/N26001. See **Figure 4-19**.

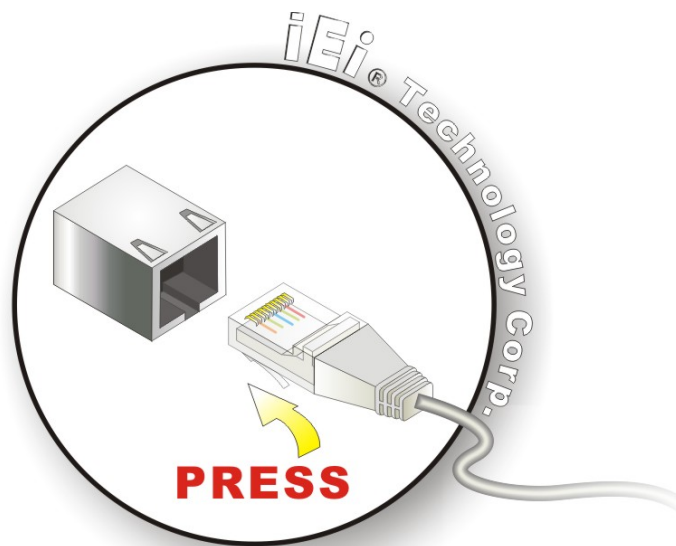

Figure 4-19: LAN Connection

## WAFER-CV-D25501/N26001 3.5" Motherboard

**Step 3:** Insert the LAN cable RJ-45 connector. Once aligned, gently insert the LAN cable RJ-45 connector into the on-board RJ-45 connector.

### 4.7.2 Serial Device Connection

The WAFER-CV-D25501/N26001 has a single male DB-9 connector on the external peripheral interface panel for a serial device. Follow the steps below to connect a serial device to the WAFER-CV-D25501/N26001.

**Step 1:** Locate the DB-9 connector. The location of the DB-9 connector is shown in Chapter 3.

**Step 2:** Insert the serial connector. Insert the DB-9 connector of a serial device into the DB-9 connector on the external peripheral interface. See **Figure 4-20**.

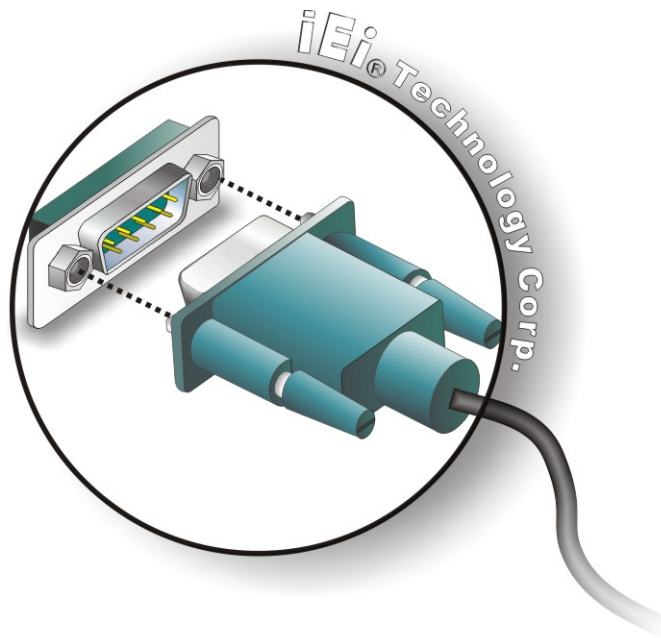

**Figure 4-20: Serial Device Connector**

**Step 3:** Secure the connector. Secure the serial device connector to the external interface by tightening the two retention screws on either side of the connector.

### 4.7.3 USB Connection (Dual Connector)

The external USB Series "A" receptacle connectors provide easier and quicker access to external USB devices. Follow the steps below to connect USB devices to the WAFER-CV-D25501/N26001.

**Step 1: Locate the USB Series "A" receptacle connectors.** The locations of the USB Series "A" receptacle connectors are shown in **Chapter 3**.

**Step 2: Insert a USB Series "A" plug.** Insert the USB Series "A" plug of a device into the USB Series "A" receptacle on the external peripheral interface. See **Figure 4-21**.

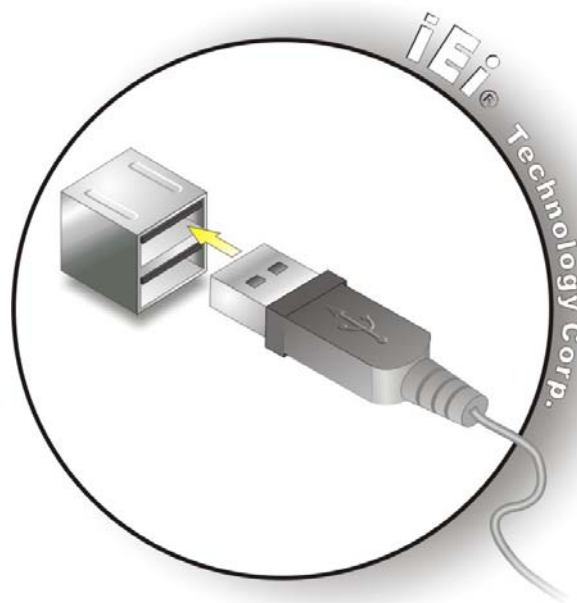

Figure 4-21: USB Connector

### 4.7.4 VGA Monitor Connection

The WAFER-CV-D25501/N26001 has a single female DB-15 connector on the external peripheral interface panel. The DB-15 connector is connected to a CRT or VGA monitor. To connect a monitor to the WAFER-CV-D25501/N26001, please follow the instructions below.

## WAFER-CV-D25501/N26001 3.5" Motherboard

- Step 1:** **Locate the female DB-15 connector.** The location of the female DB-15 connector is shown in **Chapter 3**.
- Step 2:** **Align the VGA connector.** Align the male DB-15 connector on the VGA screen cable with the female DB-15 connector on the external peripheral interface.
- Step 3:** **Insert the VGA connector** Once the connectors are properly aligned with the insert the male connector from the VGA screen into the female connector on the WAFER-CV-D25501/N26001. See **Figure 4-22**.

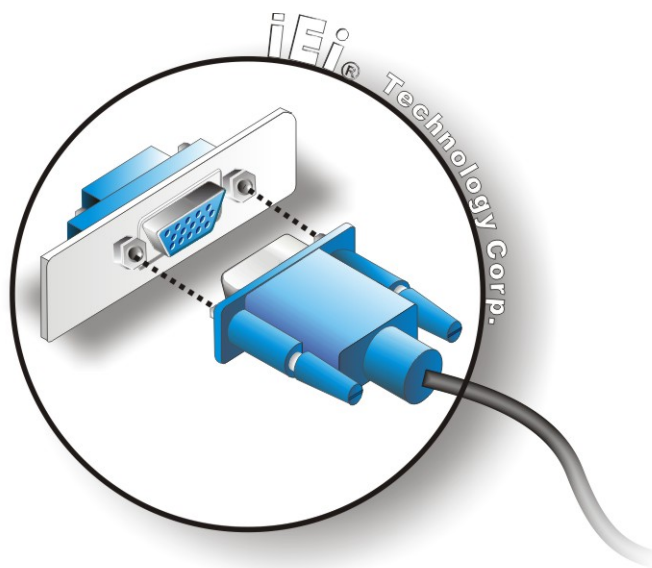

**Figure 4-22: VGA Connector**

- Step 4:** **Secure the connector.** Secure the DB-15 VGA connector from the VGA monitor to the external interface by tightening the two retention screws on either side of the connector.

## 4.8 Heat Sink Enclosure

---

**WARNING:**

Never run the WAFER-CV-D25501/N26001 without the heat sink secured to the board. The heat sink ensures the system remains cool and does not need addition heat sinks to cool the system.

---

---

**WARNING:**

When running the WAFER-CV-D25501/N26001, do not put the WAFER-CV-D25501/N26001 directly on a surface that can not dissipate system heat, especially the wooden or plastic desk. It is highly recommended to run the WAFER-CV-D25501/N26001

→ on a heat dissipation surface or

→ using copper pillars to hold the board up from the desk below

---

When the WAFER-CV-D25501/N26001 is shipped it is secured to a heat sink with five retention screws. If the WAFER-CV-D25501/N26001 must be removed from the heat sink, the five retention screws must be removed.

### WAFER-CV-D25501/N26001 3.5" Motherboard

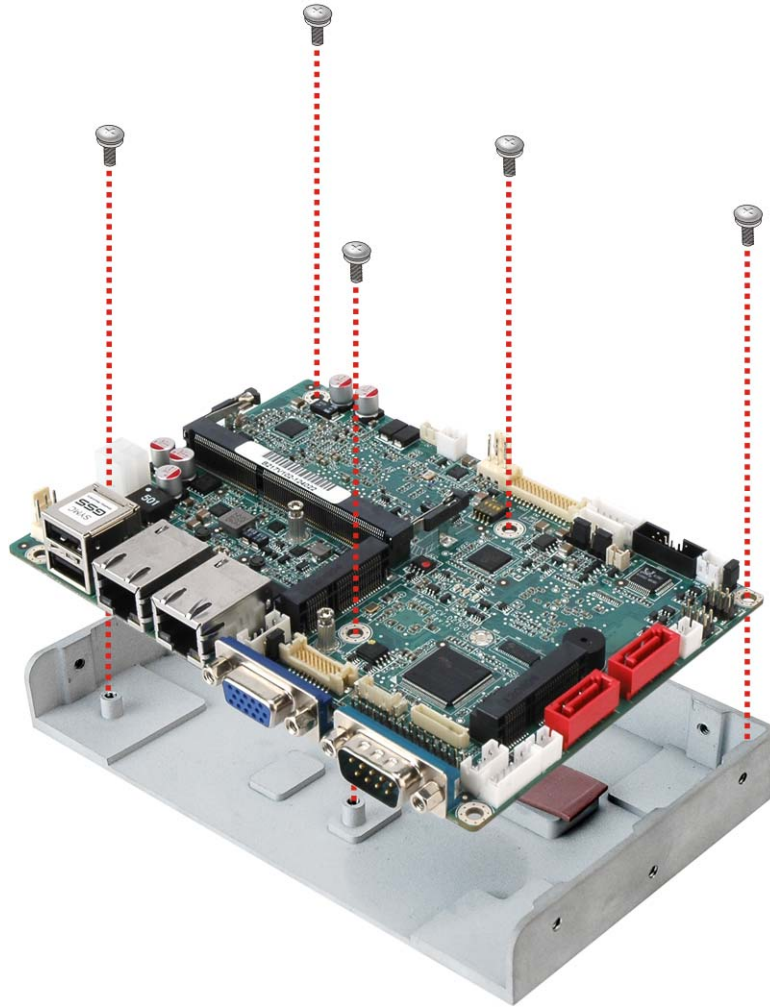

**Figure 4-23: Heat Sink Retention Screws**



Chapter

5

**BIOS**

---

## 5.1 Introduction

The BIOS is programmed onto the BIOS chip. The BIOS setup program allows changes to certain system settings. This chapter outlines the options that can be changed.

### 5.1.1 Starting Setup

The UEFI BIOS is activated when the computer is turned on. The setup program can be activated in one of two ways.

1. Press the **DEL** or **F2** key as soon as the system is turned on or
2. Press the **DEL** or **F2** key when the “**Press DEL or F2 to enter SETUP**” message appears on the screen.

If the message disappears before the **DEL** or **F2** key is pressed, restart the computer and try again.

### 5.1.2 Using Setup

Use the arrow keys to highlight items, press **ENTER** to select, use the PageUp and PageDown keys to change entries, press **F1** for help and press **ESC** to quit. Navigation keys are shown in the following table.

Key	Function
Up arrow	Move to previous item
Down arrow	Move to next item
Left arrow	Move to the item on the left hand side
Right arrow	Move to the item on the right hand side
+	Increase the numeric value or make changes
-	Decrease the numeric value or make changes
Page Up key	Move to the next page
Page Dn key	Move to the previous page



Key	Function
Esc key	Main Menu – Quit and not save changes into CMOS Status Page Setup Menu and Option Page Setup Menu -- Exit current page and return to Main Menu
F1	General help, only for Status Page Setup Menu and Option Page Setup Menu
F2	Load previous values
F3	Load optimized defaults
F4	Save changes and Exit BIOS

**Table 5-1: BIOS Navigation Keys**

### 5.1.3 Getting Help

When **F1** is pressed a small help window describing the appropriate keys to use and the possible selections for the highlighted item appears. To exit the Help Window press **Esc** or the **F1** key again.

### 5.1.4 Unable to Reboot after Configuration Changes

If the computer cannot boot after changes to the system configuration are made, CMOS defaults. Use the jumper described in Chapter 4.

### 5.1.5 BIOS Menu Bar

The **menu bar** on top of the BIOS screen has the following main items:

- Main – Changes the basic system configuration.
- Advanced – Changes the advanced system settings.
- Chipset – Changes the chipset settings.
- Boot – Changes the system boot configuration.
- Security – Sets User and Supervisor Passwords.
- Save & Exit – Selects exit options and loads default settings

The following sections completely describe the configuration options found in the menu items at the top of the BIOS screen and listed above.

## WAFER-CV-D25501/N26001 3.5" Motherboard

### 5.2 Main

The **Main** BIOS menu (**BIOS Menu 1**) appears when the **BIOS Setup** program is entered. The **Main** menu gives an overview of the basic system information.

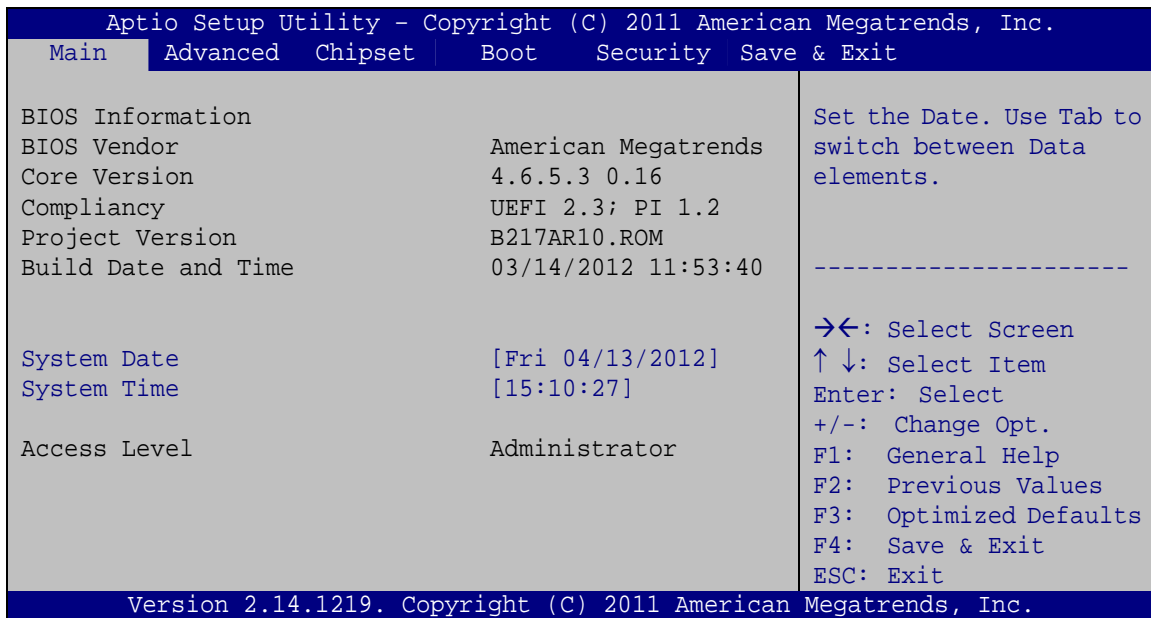

#### BIOS Menu 1: Main

##### → System Overview

The **BIOS Information** lists a brief summary of the BIOS. The fields in **BIOS Information** cannot be changed. The items shown in the system overview include:

- **BIOS Vendor:** Installed BIOS vendor
- **Core Version:** Current BIOS version
- **Project Version:** the board version
- **Build Date and Time:** Date and time the current BIOS version was made

The System Overview field also has two user configurable fields:

##### → System Date [xx/xx/xx]

Use the **System Date** option to set the system date. Manually enter the day, month and year.

→ **System Time [xx:xx:xx]**

Use the **System Time** option to set the system time. Manually enter the hours, minutes and seconds.

### 5.3 Advanced

Use the **Advanced** menu (**BIOS Menu 2**) to configure the CPU and peripheral devices through the following sub-menus:



**WARNING:**

Setting the wrong values in the sections below may cause the system to malfunction. Make sure that the settings made are compatible with the hardware.

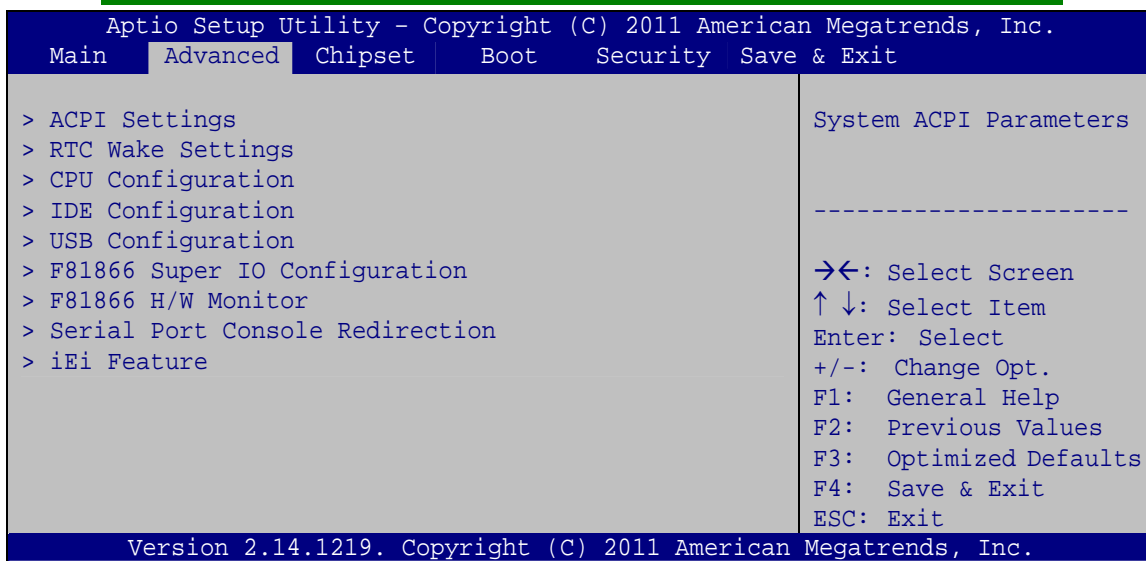

**BIOS Menu 2: Advanced**

#### 5.3.1 ACPI Settings

The **ACPI Settings** menu (**BIOS Menu 3**) configures the Advanced Configuration and Power Interface (ACPI) options.

## WAFER-CV-D25501/N26001 3.5" Motherboard

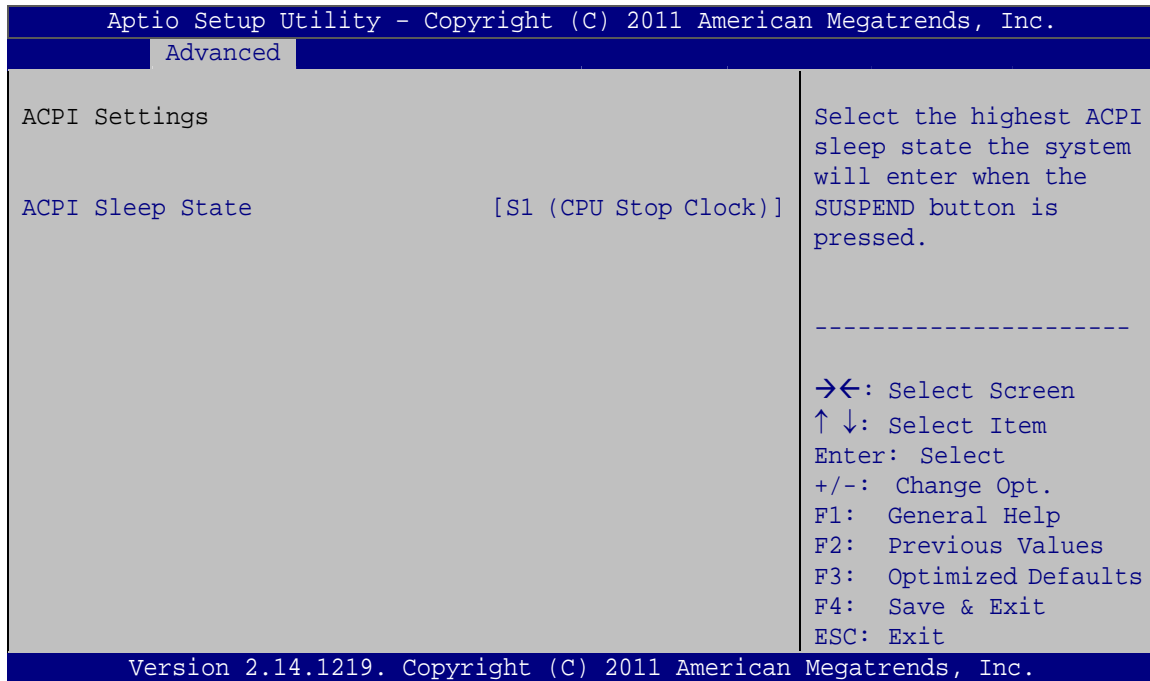

### BIOS Menu 3: ACPI Settings

#### → ACPI Sleep State [S1 (CPU Stop Clock)]

Use the **ACPI Sleep State** option to specify the sleep state the system enters when it is not being used.

- **S1 (CPU Stop Clock)** **DEFAULT** The system enters S1 (POS) sleep state. The system appears off. The CPU is stopped; RAM is refreshed; the system is running in a low power mode.
- **S3 (Suspend to RAM)** The caches are flushed and the CPU is powered off. Power to the RAM is maintained. The computer returns slower to a working state, but more power is saved.

### 5.3.2 RTC Wake Settings

The **RTC Wake Settings** menu (**BIOS Menu 4**) enables the system to wake at the specified time.

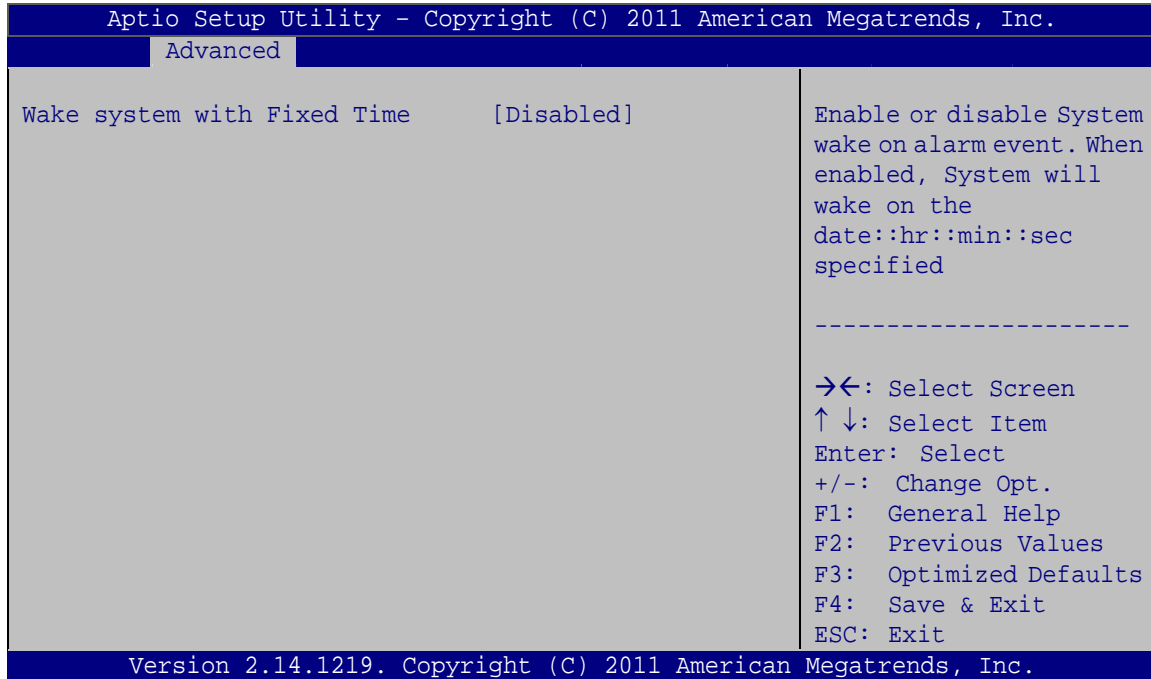
**BIOS Menu 4: RTC Wake Settings**
**→ Wake system with Fixed Time [Disabled]**

Use the **Wake system with Fixed Time** option to enable or disable the system wake on alarm event.

→ **Disabled**      **DEFAULT**      The real time clock (RTC) cannot generate a wake event

→ **Enabled**      If selected, the **Wake up every day** option appears allowing you to enable to disable the system to wake every day at the specified time. Besides, the following options appear with values that can be selected:

Wake up date

Wake up hour

Wake up minute

Wake up second

After setting the alarm, the computer turns itself on from a suspend state when the alarm goes off.

## WAFER-CV-D25501/N26001 3.5" Motherboard

### 5.3.3 CPU Configuration

Use the **CPU Configuration** menu (**BIOS Menu 5**) to view detailed CPU specifications and configure the CPU.

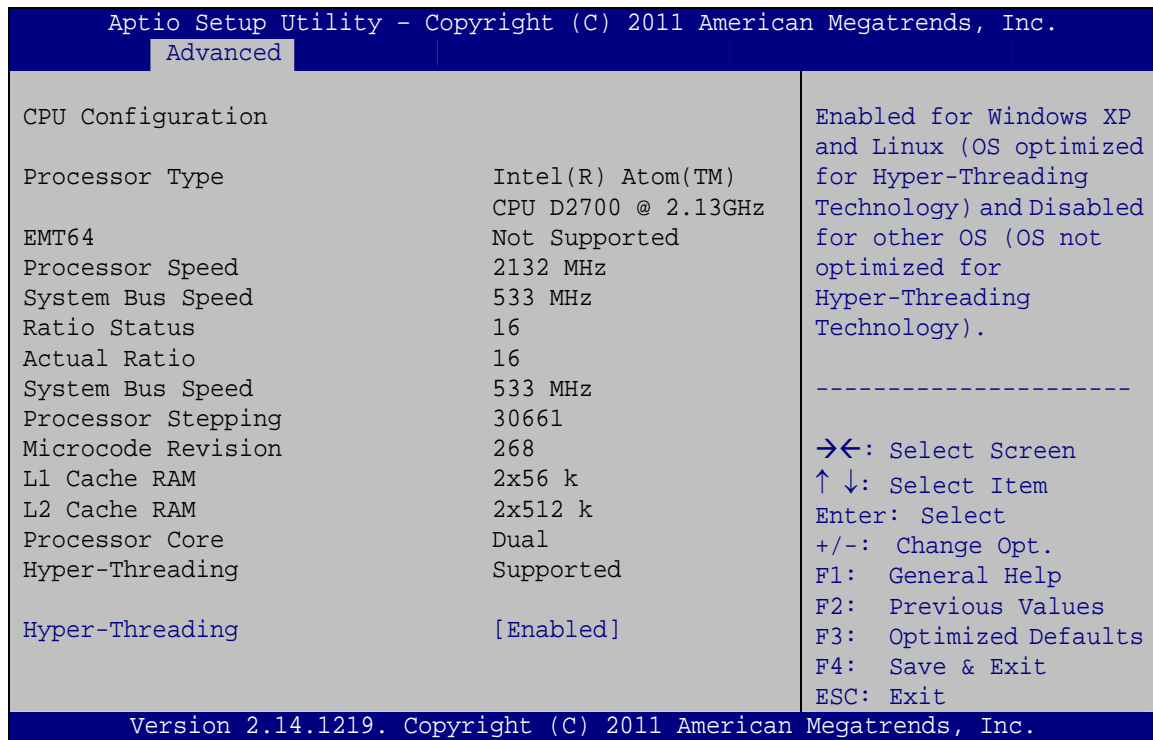

#### BIOS Menu 5: CPU Configuration

The CPU Configuration menu (**BIOS Menu 5**) lists the following CPU details:

- **Processor Type:** Lists the brand name of the CPU being used.
- **EMT64:** Indicates if EMT64 is supported by the CPU.
- **Processor Speed:** Lists the CPU processing speed.
- **System Bus Speed:** Lists the system bus speed.
- **Ratio Status:** Lists the ratio status.
- **Actual Ratio:** Lists the ratio of the frequency to the clock speed.
- **Processor Stepping:** Lists the CPU ID.
- **Microcode Revision:** Lists the microcode revision.
- **L1 Cache RAM:** Lists the CPU L1 cache size.
- **L2 Cache RAM:** Lists the CPU L2 cache size.
- **Processor Core:** Lists the number of the processor core.
- **Hyper-Threading:** Indicates if Intel HT Technology is supported by the CPU.

➔ **Hyper-Threading [Enabled]**

Use the **Hyper-Threading** BIOS option to enable or disable the Intel Hyper-Threading Technology.

- ➔ **Disabled**                      Disables the Intel Hyper-Threading Technology.
- ➔ **Enabled**    **DEFAULT**      Enables the Intel Hyper-Threading Technology.

### 5.3.4 IDE Configuration

Use the **IDE Configuration** menu (**BIOS Menu 6**) to change and/or set the configuration of the SATA devices installed in the system.

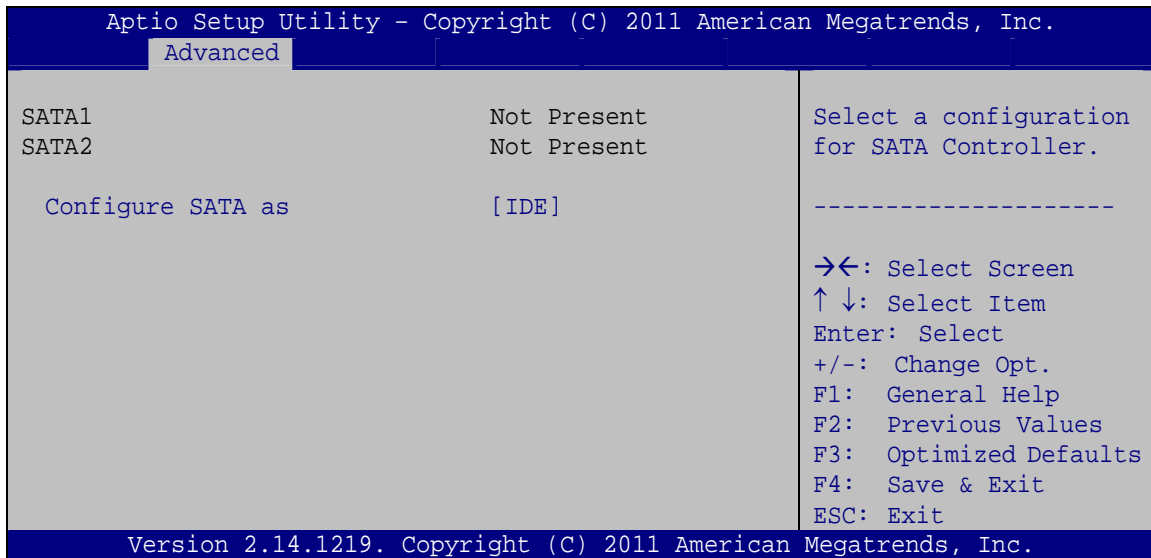

**BIOS Menu 6: IDE Configuration**

➔ **Configure SATA as [IDE]**

Use the **Configure SATA as** option to configure SATA devices as normal IDE or AHCI devices.

- ➔ **IDE**                      **DEFAULT**      Configures SATA devices as normal IDE device.
- ➔ **AHCI**                      Configures SATA devices as AHCI device.

## WAFER-CV-D25501/N26001 3.5" Motherboard

### 5.3.5 USB Configuration

Use the **USB Configuration** menu (**BIOS Menu 7**) to read USB configuration information and configure the USB settings.

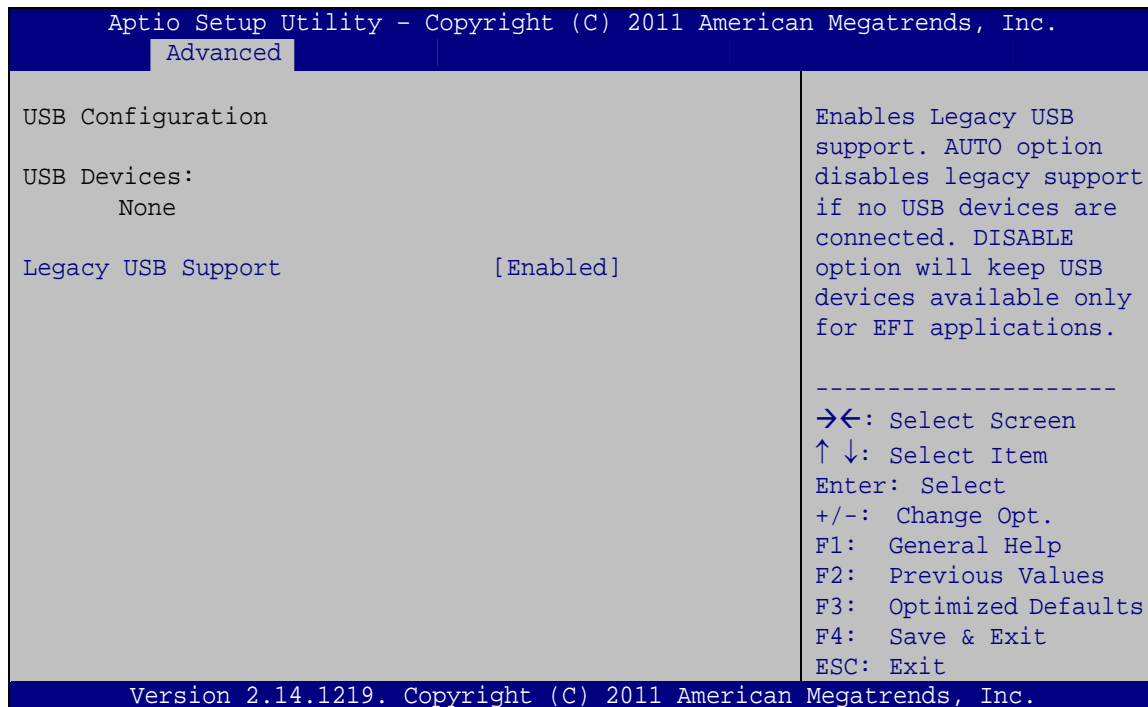

#### BIOS Menu 7: USB Configuration

##### → Legacy USB Support [Enabled]

Use the **Legacy USB Support** BIOS option to enable USB mouse and USB keyboard support.

Normally if this option is not enabled, any attached USB mouse or USB keyboard does not become available until a USB compatible operating system is fully booted with all USB drivers loaded. When this option is enabled, any attached USB mouse or USB keyboard can control the system even when there is no USB driver loaded onto the system.

- **Disabled** Legacy USB support disabled
- **Enabled**     **DEFAULT** Legacy USB support enabled
- **Auto** Legacy USB support disabled if no USB devices are connected



### 5.3.6 F81866 Super IO Configuration

Use the **F81866 Super IO Configuration** menu (**BIOS Menu 8**) to set or change the configurations for the serial ports.

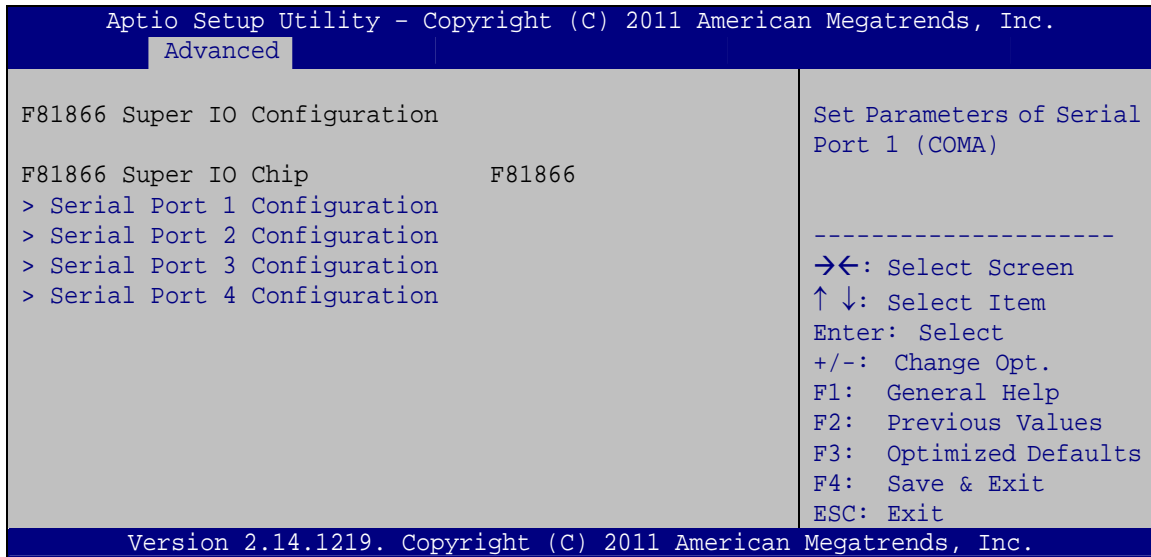

**BIOS Menu 8: Super IO Configuration**

#### 5.3.6.1 Serial Port n Configuration

Use the **Serial Port n Configuration** menu (**BIOS Menu 9**) to configure the serial port n.

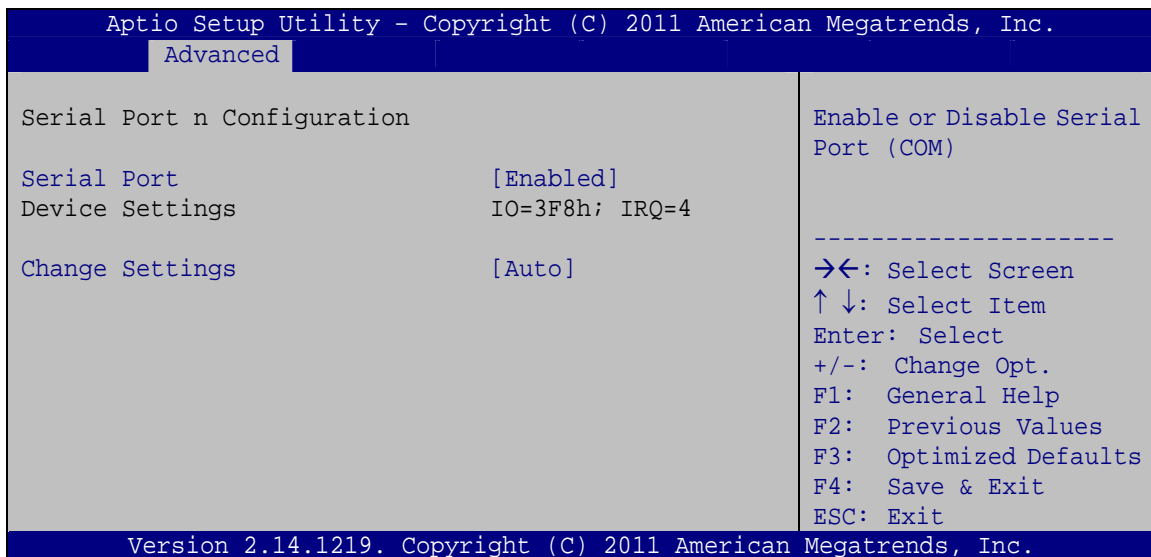

**BIOS Menu 9: Serial Port n Configuration Menu**

## WAFER-CV-D25501/N26001 3.5" Motherboard

### 5.3.6.1.1 Serial Port 1 Configuration

#### → Serial Port [Enabled]

Use the **Serial Port** option to enable or disable the serial port.

- **Disabled**                      Disable the serial port
- **Enabled**      **DEFAULT**      Enable the serial port

#### → Change Settings [Auto]

Use the **Change Settings** option to change the serial port IO port address and interrupt address.

- **Auto**              **DEFAULT**      The serial port IO port address and interrupt address are automatically detected.
- **IO=3F8h;**  
**IRQ=4**                      Serial Port I/O port address is 3F8h and the interrupt address is IRQ4
- **IO=3F8h;**  
**IRQ=3, 4**                      Serial Port I/O port address is 3F8h and the interrupt address is IRQ3, 4
- **IO=2F8h;**  
**IRQ=3, 4**                      Serial Port I/O port address is 2F8h and the interrupt address is IRQ3, 4
- **IO=3E8h;**  
**IRQ=3, 4**                      Serial Port I/O port address is 3E8h and the interrupt address is IRQ3, 4
- **IO=2E8h;**  
**IRQ=3, 4**                      Serial Port I/O port address is 2E8h and the interrupt address is IRQ3, 4

### 5.3.6.1.2 Serial Port 2 Configuration

#### → Serial Port [Enabled]

Use the **Serial Port** option to enable or disable the serial port.

- **Disabled**                      Disable the serial port
- **Enabled**      **DEFAULT**      Enable the serial port

**→ Change Settings [Auto]**

Use the **Change Settings** option to change the serial port IO port address and interrupt address.

- Auto                      DEFAULT**      The serial port IO port address and interrupt address are automatically detected.
- IO=2F8h;  
IRQ=3**                                      Serial Port I/O port address is 2F8h and the interrupt address is IRQ3
- IO=3F8h;  
IRQ=3, 4**                                      Serial Port I/O port address is 3F8h and the interrupt address is IRQ3, 4
- IO=2F8h;  
IRQ=3, 4**                                      Serial Port I/O port address is 2F8h and the interrupt address is IRQ3, 4
- IO=3E8h;  
IRQ=3, 4**                                      Serial Port I/O port address is 3E8h and the interrupt address is IRQ3, 4
- IO=2E8h;  
IRQ=3, 4**                                      Serial Port I/O port address is 2E8h and the interrupt address is IRQ3, 4

**5.3.6.1.3 Serial Port 3 Configuration**
**→ Serial Port [Enabled]**

Use the **Serial Port** option to enable or disable the serial port.

- Disabled**                                      Disable the serial port
- Enabled                      DEFAULT**      Enable the serial port

**→ Change Settings [Auto]**

Use the **Change Settings** option to change the serial port IO port address and interrupt address.

- Auto                      DEFAULT**      The serial port IO port address and interrupt address are automatically detected.

## WAFER-CV-D25501/N26001 3.5" Motherboard

- **IO=3E8h;**  
**IRQ=10**                      Serial Port I/O port address is 3E8h and the interrupt address is IRQ10
- **IO=3F8h;**  
**IRQ=10, 11**                  Serial Port I/O port address is 3F8h and the interrupt address is IRQ10, 11
- **IO=2F8h;**  
**IRQ=10, 11**                  Serial Port I/O port address is 2F8h and the interrupt address is IRQ10, 11
- **IO=3E8h;**  
**IRQ=10, 11**                  Serial Port I/O port address is 3E8h and the interrupt address is IRQ10, 11
- **IO=2E8h;**  
**IRQ=10, 11**                  Serial Port I/O port address is 2E8h and the interrupt address is IRQ10, 11
- **IO=250h;**  
**IRQ=10, 11**                  Serial Port I/O port address is 250h and the interrupt address is IRQ10, 11
- **IO=2E0h;**  
**IRQ=10, 11**                  Serial Port I/O port address is 2E0h and the interrupt address is IRQ10, 11

### 5.3.6.1.4 Serial Port 4 Configuration

#### → Serial Port [Enabled]

Use the **Serial Port** option to enable or disable the serial port.

- **Disabled**                      Disable the serial port
- **Enabled      DEFAULT**      Enable the serial port

#### → Change Settings [Auto]

Use the **Change Settings** option to change the serial port IO port address and interrupt address.

- **Auto              DEFAULT**      The serial port IO port address and interrupt address are automatically detected.
- **IO=2E8h;**  
**IRQ=10**                      Serial Port I/O port address is 2E8h and the interrupt address is IRQ10

- ➔ **IO=3F8h;** Serial Port I/O port address is 3F8h and the interrupt address is IRQ10, 11  
**IRQ=10, 11**
- ➔ **IO=2F8h;** Serial Port I/O port address is 2F8h and the interrupt address is IRQ10, 11  
**IRQ=10, 11**
- ➔ **IO=3E8h;** Serial Port I/O port address is 3E8h and the interrupt address is IRQ10, 11  
**IRQ=10, 11**
- ➔ **IO=2E8h;** Serial Port I/O port address is 2E8h and the interrupt address is IRQ10, 11  
**IRQ=10, 11**
- ➔ **IO=250h;** Serial Port I/O port address is 250h and the interrupt address is IRQ10, 11  
**IRQ=10, 11**
- ➔ **IO=2E0h;** Serial Port I/O port address is 2E0h and the interrupt address is IRQ10, 11  
**IRQ=10, 11**

### 5.3.7 F81866 H/W Monitor

The **F81866 H/W Monitor** menu (**BIOS Menu 10**) contains the fan configuration submenus and displays operating temperature, fan speeds and system voltages.

```

Aptio Setup Utility - Copyright (C) 2011 American Megatrends, Inc.
  Advanced
PC Health Status
> Smart Fan Mode Configuration
CPU Temperature           : +52 C
System Temperature       : +51 C
CPU_FAN1 Speed           : N/A
SYS_FAN1 Speed           : N/A
+VCC_CPU                  : +1.488 V
+VCC_GFX                  : +0.968 V
+V1.05S                   : +1.056 V
+V1.5_DDR3                : +1.504 V
VSB5V                     : +5.040 V
+V3.3S                    : +3.344 V
VSB3V                     : +3.344 V
VBAT                      : +3.264 V
Smart Fan Mode Select
-----
-><: Select Screen
↑↓: Select Item
Enter: Select
+/-: Change Opt.
F1: General Help
F2: Previous Values
F3: Optimized Defaults
F4: Save & Exit
ESC: Exit
Version 2.14.1219. Copyright (C) 2011 American Megatrends, Inc.
  
```

**BIOS Menu 10: F81866 H/W Monitor**

## WAFER-CV-D25501/N26001 3.5" Motherboard

### → PC Health Status

The following system parameters and values are shown. The system parameters that are monitored are:

- System Temperatures:
  - CPU Temperature
  - System Temperature
- Fan Speeds:
  - CPU Fan Speed
  - System Fan Speed
- Voltages:
  - +VCC\_CPU
  - +VCC\_GFX
  - +V1.05S
  - +1.5\_DDR3
  - VSB5V
  - +V3.3S
  - VSB3V
  - VBAT

### 5.3.7.1 Smart Fan Mode Configuration

Use the **Smart Fan Mode Configuration** submenu (**BIOS Menu 11**) to configure fan temperature and speed settings.

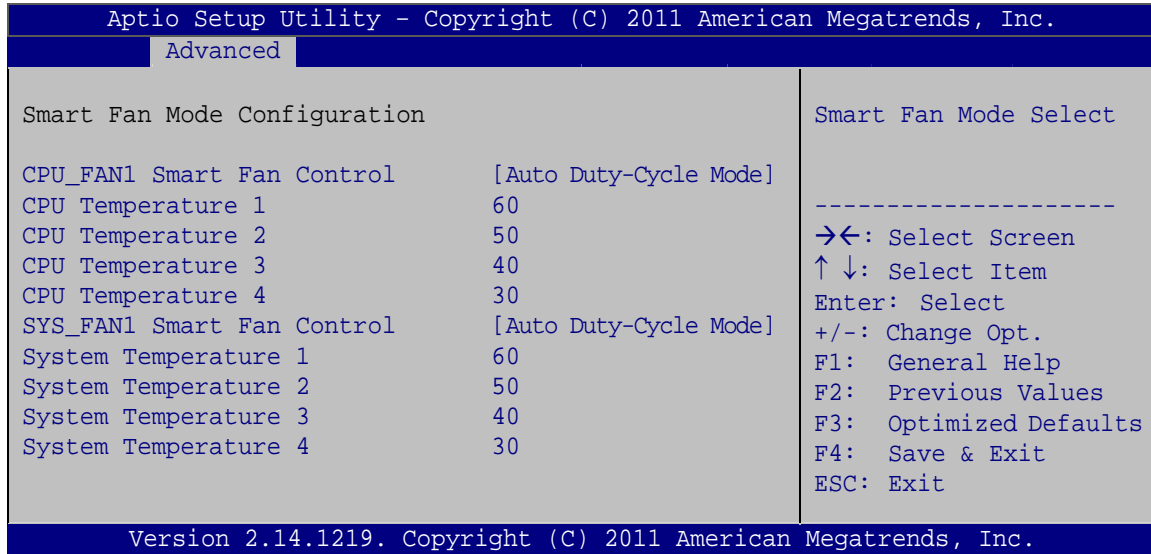

### BIOS Menu 11: Smart Fan Mode Configuration

#### → CPU\_FAN1/SYS\_FAN Smart Fan Control [Auto Duty-Cycle Mode]

Use the **CPU\_FAN1** or **SYS\_FAN1 Smart Fan Control** option to configure the CPU or System Smart Fan.

- **Auto Duty-Cycle Mode**      **DEFAULT**      The fan adjusts its speed using Auto Duty-Cycle settings
- **Manual Duty Mode**      The fan spins at the speed set in Manual Duty Mode settings

#### → CPU/System Temperature n

Use the + or – key to change the fan **CPU** or **System Temperature n** value. Enter a decimal number between 1 and 100.

### 5.3.8 Serial Port Console Redirection

The **Serial Port Console Redirection** menu (**BIOS Menu 12**) allows the console redirection options to be configured. Console redirection allows users to maintain a system remotely by re-directing keyboard input and text output through the serial port.

## WAFER-CV-D25501/N26001 3.5" Motherboard

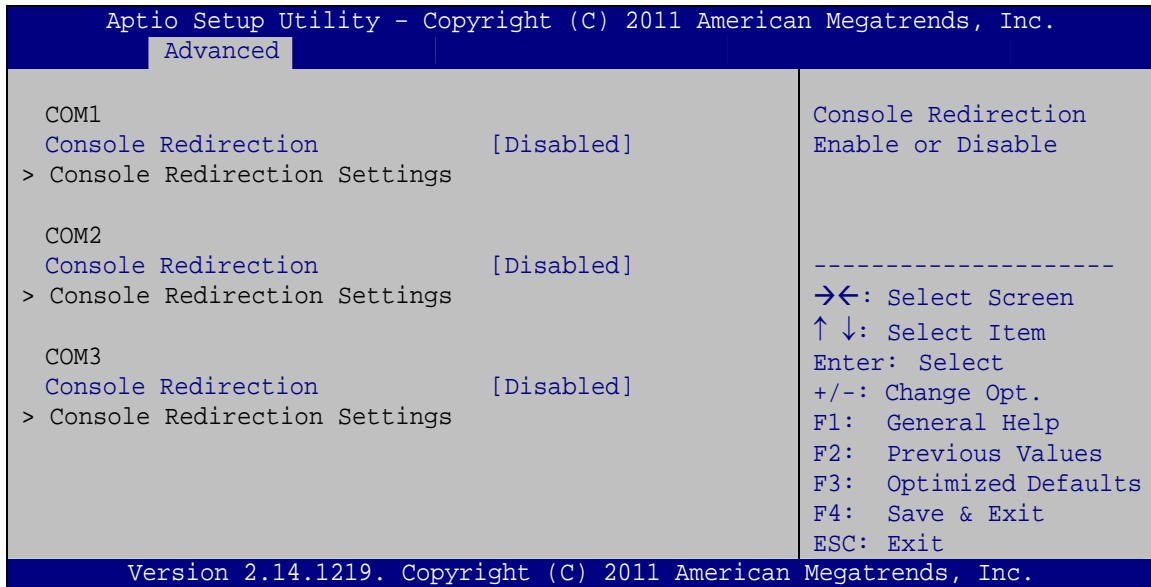

### BIOS Menu 12: Serial Port Console Redirection

#### → Console Redirection [Disabled]

Use **Console Redirection** option to enable or disable the console redirection function.

- **Disabled**      **DEFAULT**      Disabled the console redirection function
- **Enabled**                      Enabled the console redirection function

#### → Terminal Type [ANSI]

Use the **Terminal Type** option to specify the remote terminal type.

- **VT100**                      The target terminal type is VT100
- **VT100+**                      The target terminal type is VT100+
- **VT-UTF8**                      The target terminal type is VT-UTF8
- **ANSI**                      **DEFAULT**      The target terminal type is ANSI

#### → Bits per second [115200]

Use the **Bits per second** option to specify the serial port transmission speed. The speed must match the other side. Long or noisy lines may require lower speeds.



- **9600**                      Sets the serial port transmission speed at 9600.
- **19200**                     Sets the serial port transmission speed at 19200.
- **38400**                     Sets the serial port transmission speed at 38400.
- **57600**                     Sets the serial port transmission speed at 57600.
- **115200**                  **DEFAULT**      Sets the serial port transmission speed at 115200.

→ **Data Bits [8]**

Use the **Data Bits** option to specify the number of data bits.

- **7**                              Sets the data bits at 7.
- **8**                              **DEFAULT**      Sets the data bits at 8.

→ **Parity [None]**

Use the **Parity** option to specify the parity bit that can be sent with the data bits for detecting the transmission errors.

- **None**                      **DEFAULT**      No parity bit is sent with the data bits.
- **Even**                      The parity bit is 0 if the number of ones in the data bits is even.
- **Odd**                        The parity bit is 0 if the number of ones in the data bits is odd.
- **Mark**                      The parity bit is always 1. This option does not provide error detection.
- **Space**                     The parity bit is always 0. This option does not provide error detection.

→ **Stop Bits [1]**

Use the **Stop Bits** option to specify the number of stop bits used to indicate the end of a serial data packet. Communication with slow devices may require more than 1 stop bit.

## WAFER-CV-D25501/N26001 3.5" Motherboard

- ➔ 1            **DEFAULT**      Sets the number of stop bits at 1.
- ➔ 2                              Sets the number of stop bits at 2.

### 5.3.9 iEi Feature

Use the **iEi Feature** menu (**BIOS Menu 13**) to configure One Key Recovery function.

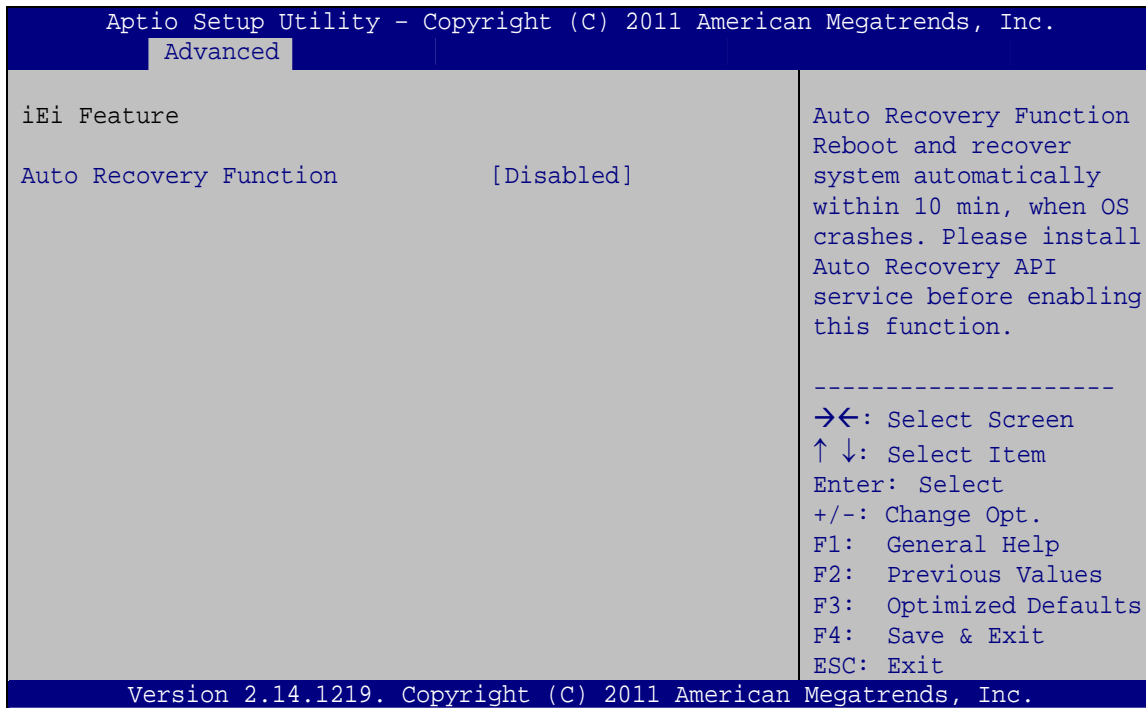

#### BIOS Menu 13: IEI Feature

#### ➔ Auto Recovery Function [Disabled]

Use the **Auto Recovery Function** BIOS option to enable or disable the auto recovery function of the IEI One Key Recovery.

- ➔ **Disabled**      **DEFAULT**      Auto recovery function disabled
- ➔ **Enabled**                      Auto recovery function enabled

## 5.4 Chipset

Use the **Chipset** menu (**BIOS Menu 14**) to access the Host Bridge and Southbridge configuration menus.



### **WARNING!**

Setting the wrong values for the Chipset BIOS selections in the Chipset BIOS menu may cause the system to malfunction.

```

Aptio Setup Utility - Copyright (C) 2011 American Megatrends, Inc.
Main   Advanced  Chipset  Boot   Security  Save & Exit
-----
> Host Bridge
> South Bridge

Host Bridge Parameters
-----
-><: Select Screen
↑↓: Select Item
Enter: Select
+/-: Change Opt.
F1: General Help
F2: Previous Values
F3: Optimized Defaults
F4: Save & Exit
ESC: Exit

Version 2.14.1219. Copyright (C) 2011 American Megatrends, Inc.
    
```

### **BIOS Menu 14: Chipset**

#### 5.4.1 Host Bridge Configuration

Use the **Host Bridge Configuration** menu (**BIOS Menu 15**) to configure the Intel IGD Configuration and display the memory information.

## WAFER-CV-D25501/N26001 3.5" Motherboard

```

Aptio Setup Utility - Copyright (C) 2011 American Megatrends, Inc.
  Chipset
  > Intel IGD Configuration
  ***** Memory Information *****

Memory Frequency           1067 MHz(DDR3)
Total Memory                1024 MB
DIMM#1                     1024 MB

Config Intel IGD Settings
-----
-><: Select Screen
↑↓: Select Item
Enter: Select
+/-: Change Opt.
F1:  General Help
F2:  Previous Values
F3:  Optimized Defaults
F4:  Save & Exit
ESC: Exit

Version 2.14.1219. Copyright (C) 2011 American Megatrends, Inc.
  
```

### BIOS Menu 15: Host Bridge Configuration

#### 5.4.1.1 Intel IGD Configuration

Use the **Intel IGD Configuration** submenu (**BIOS Menu 16**) to configure the video device connected to the system.

```

Aptio Setup Utility - Copyright (C) 2011 American Megatrends, Inc.
  Advanced
  Intel IGD Configuration
  IGFX - Boot Type           [VBIOS Default]
  LVDS1 Panel Type          [800x600 LVDS]
  Backlight Control         [Inverted]
  Fixed Graphics Memory Size [128MB]

  Select the Video Device
  which will be activated
  during POST. This has no
  effect if external
  graphics present.

  -----
  -><: Select Screen
  ↑↓: Select Item
  Enter: Select
  +/-: Change Opt.
  F1:  General Help
  F2:  Previous Values
  F3:  Optimized Defaults
  F4:  Save & Exit
  ESC: Exit

  Version 2.14.1219. Copyright (C) 2011 American Megatrends, Inc.
  
```

### BIOS Menu 16: Intel IGD Configuration

→ **IGFX - Boot Type [VBIOS Default]**

Use the **IGFX - Boot Type** option to select the display device used by the system when it boots. Configuration options are listed below.

- VBIOS Default    **DEFAULT**
- CRT
- LVDS1
- LVDS2

→ **LVDS1 Panel Type [800x600 LVDS]**

Use the **LVDS1 Panel Type** option to select the type of flat panel connected to the system. Configuration options are listed below.

- 640x480 LVDS
- 800x600 LVDS    **DEFAULT**
- 1024x768 LVDS
- 1280x1024 LVDS
- 1366x768 LVDS
- 1224x600 LVDS
- 1280x800 LVDS

→ **Backlight Control [Inverted]**

Use the **Backlight Control** option to select the backlight control mode.

- **Normal**                      Brightest at high voltage level
- **Inverted**    **DEFAULT**      Brightest at low voltage level

→ **Fixed Graphics Memory Size [128MB]**

Use the **Fixed Graphics Memory Size** option to specify the maximum amount of memory that can be allocated as graphics memory. Configuration options are listed below.

- 128MB            **DEFAULT**
- 256MB

## WAFER-CV-D25501/N26001 3.5" Motherboard

### 5.4.2 South Bridge Configuration

Use the **South Bridge Configuration** menu (**BIOS Menu 17**) to configure the Southbridge chipset.

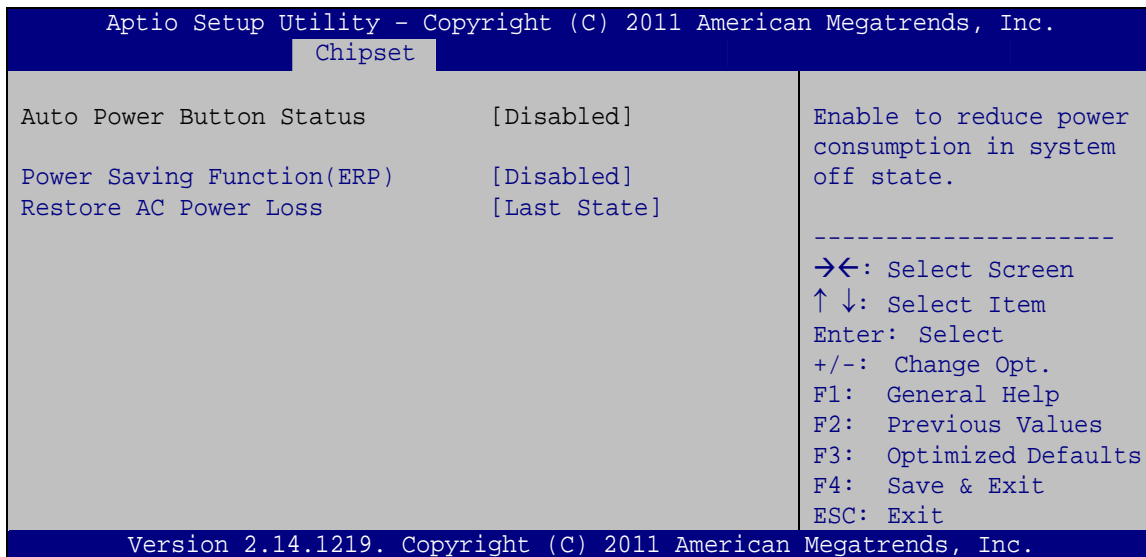

#### BIOS Menu 17: Southbridge Chipset Configuration

##### → Power Saving Function(ERP) [Disabled]

Use the **Power Saving Function(ERP)** option to enable or disable the power saving function.

- **Disabled**    **DEFAULT**    Disables the power saving function.
- **Enabled**                    Enables the power saving function.

##### → Restore AC Power Loss [Last State]

Use the **Restore AC Power Loss** BIOS option to specify what state the system returns to if there is a sudden loss of power to the system.

- **Power Off**                    The system remains turned off
- **Power On**                    The system turns on
- **Last State**    **DEFAULT**    The system returns to its previous state. If it was on, it turns itself on. If it was off, it remains off.

## 5.5 Boot

Use the **Boot menu (BIOS Menu 18)** to configure system boot options.

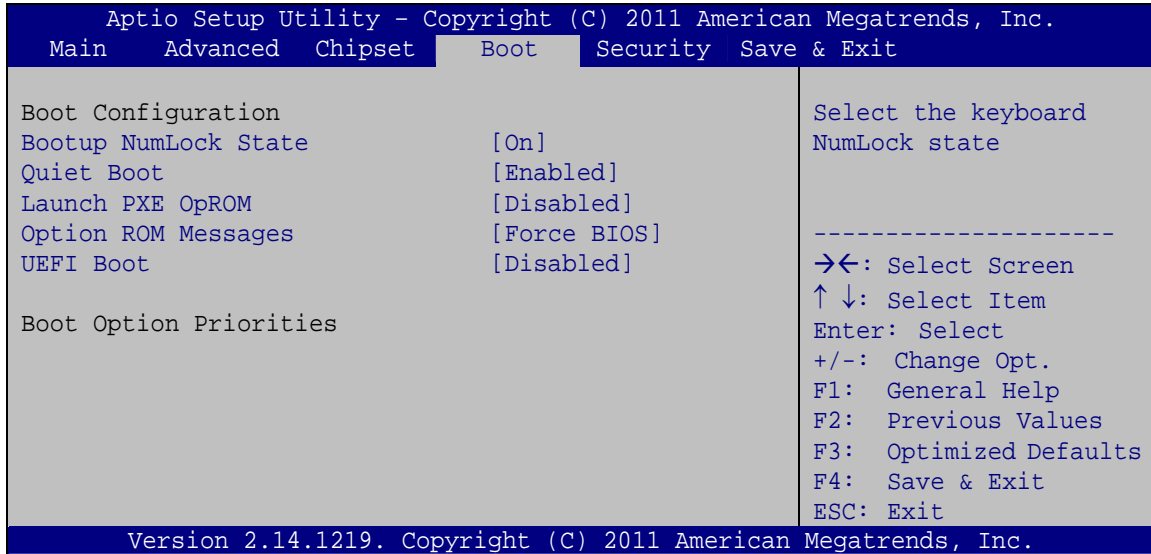

### BIOS Menu 18: Boot

#### → Bootup NumLock State [On]

Use the **Bootup NumLock State** BIOS option to specify if the number lock setting must be modified during boot up.

→ **On**                      **DEFAULT**                      Allows the Number Lock on the keyboard to be enabled automatically when the computer system boots up. This allows the immediate use of the 10-key numeric keypad located on the right side of the keyboard. To confirm this, the Number Lock LED light on the keyboard is lit.

→ **Off**                                              Does not enable the keyboard Number Lock automatically. To use the 10-keys on the keyboard, press the Number Lock key located on the upper left-hand corner of the 10-key pad. The Number Lock LED on the keyboard lights up when the Number Lock is engaged.

## WAFER-CV-D25501/N26001 3.5" Motherboard

### → Quiet Boot [Enabled]

Use the **Quiet Boot** BIOS option to select the screen display when the system boots.

- **Disabled** Normal POST messages displayed
- **Enabled** **DEFAULT** OEM Logo displayed instead of POST messages

### → Launch PXE OpROM [Disabled]

Use the **Launch PXE OpROM** option to enable or disable boot option for legacy network devices.

- **Disabled** **DEFAULT** Ignore all PXE Option ROMs
- **Enabled** Load PXE Option ROMs.

### → Option ROM Messages [Force BIOS]

Use the **Option ROM Messages** option to set the Option ROM display mode.

- **Force BIOS** **DEFAULT** Sets display mode to force BIOS.
- **Keep Current** Sets display mode to current.

### → UEFI Boot [Disabled]

Use the **UEFI Boot** BIOS option to allow the system to boot from the UEFI devices.

- **Disabled** **DEFAULT** Disables to boot from the UEFI devices.
- **Enabled** Enables to boot from the UEFI devices.



## 5.6 Security

Use the **Security** menu (**BIOS Menu 19**) to set system and user passwords.

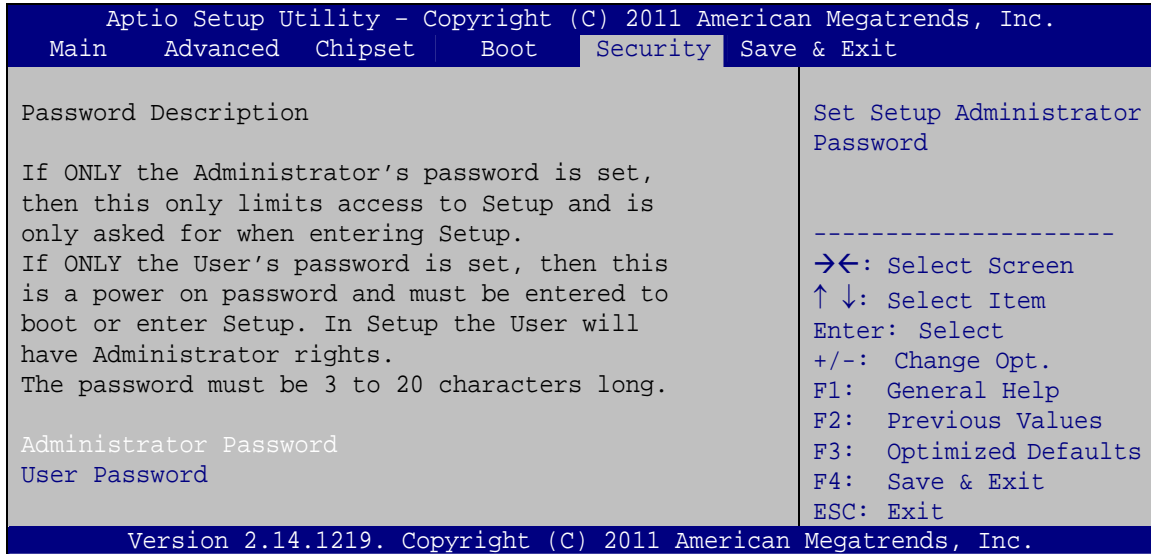

### BIOS Menu 19: Security

#### → Administrator Password

Use the **Administrator Password** to set or change a administrator password.

#### → User Password

Use the **User Password** to set or change a user password.

## 5.7 Exit

Use the **Exit** menu (**BIOS Menu 20**) to load default BIOS values, optimal failsafe values and to save configuration changes.

## WAFER-CV-D25501/N26001 3.5" Motherboard

```

Aptio Setup Utility - Copyright (C) 2011 American Megatrends, Inc.
Main   Advanced  Chipset  Boot   Security  Save & Exit

Save Changes and Reset
Discard Changes and Reset

Restore Defaults
Save as User Defaults
Restore User Defaults

Reset the system after
saving the changes.

-----
-><: Select Screen
↑↓: Select Item
Enter: Select
+/-: Change Opt.
F1:  General Help
F2:  Previous Values
F3:  Optimized Defaults
F4:  Save & Exit
ESC: Exit

Version 2.14.1219. Copyright (C) 2011 American Megatrends, Inc.
  
```

### BIOS Menu 20:Exit

#### → Save Changes and Reset

Use the **Save Changes and Reset** option to save the changes made to the BIOS options and reset the system.

#### → Discard Changes and Reset

Use the **Discard Changes and Reset** option to exit the system without saving the changes made to the BIOS configuration setup program.

#### → Restore Defaults

Use the **Restore Defaults** option to load the optimal default values for each of the parameters on the Setup menus. **F3 key can be used for this operation.**

#### → Save as User Defaults

Use the **Save as User Defaults** option to save the changes done so far as user defaults.

#### → Restore User Defaults

Use the **Restore User Defaults** option to restore the user defaults to all the setup options.



Chapter

6

# Software Drivers

---

## 6.1 Available Software Drivers

---

**NOTE:**

The content of the CD may vary throughout the life cycle of the product and is subject to change without prior notice. Visit the IEI website or contact technical support for the latest updates.

---

The following drivers can be installed on the system:

- Chipset
- Graphics
- LAN
- Audio

Installation instructions are given below.

## 6.2 Starting the Driver Program

To access the driver installation programs, please do the following.

**Step 1:** Insert the CD that came with the system into a CD drive connected to the system.

---

**NOTE:**

If the installation program doesn't start automatically:  
Click "Start->Computer->CD Drive->autorun.exe"

---

**Step 2:** The driver main menu appears (**Figure 6-1**).



**Figure 6-1: Start Up Screen**

**Step 3:** Click WAFER-CV-D25501/N26001.

**Step 4:** The list of drivers in **Figure 6-2** appears.



**Figure 6-2: Drivers**

## 6.3 Chipset Driver Installation

To install the chipset driver, please do the following.

**Step 1:** Access the driver list. (See **Section 6.2**)

**Step 2:** Click “1-Chipset”.

**Step 3:** Go to the 32-bit or 64-bit folder that corresponds to your OS version.

**Step 4:** Open the **Intel Chipset Software Installation Utility** folder.

**Step 5:** Double click the **infinst\_autol** icon.

**Step 6:** The setup files are extracted as shown in **Figure 6-3**.

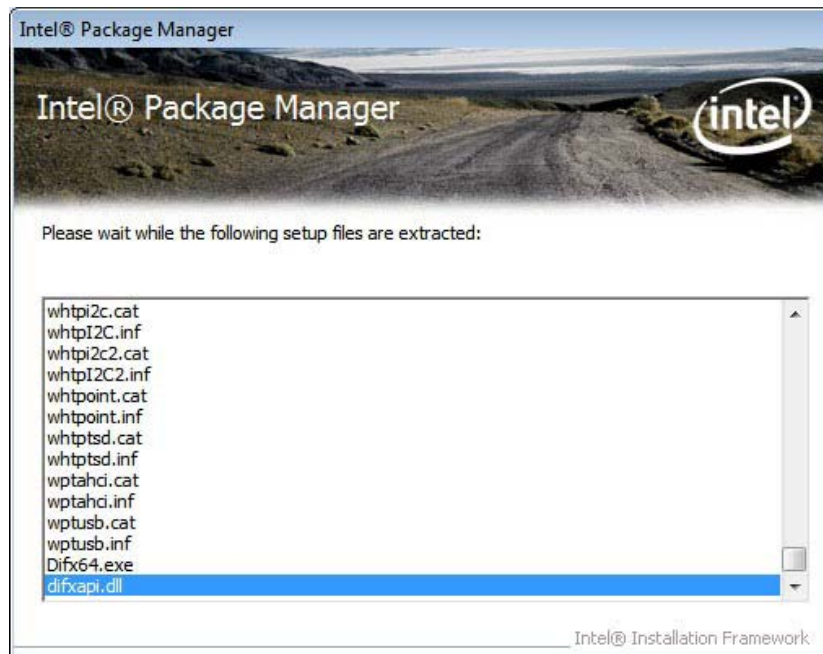

**Figure 6-3: Chipset Driver Screen**

**Step 7:** When the setup files are completely extracted, the **Welcome Screen** in **Figure 6-4** appears.

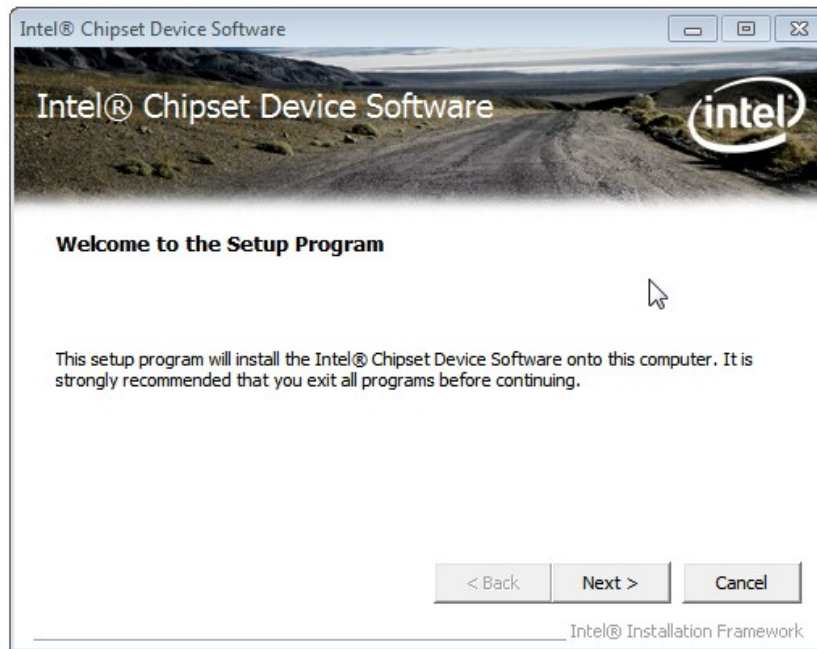

**Figure 6-4: Chipset Driver Welcome Screen**

**Step 8:** Click **Next** to continue.

**Step 9:** The license agreement in **Figure 6-5** appears.

**Step 10:** Read the **License Agreement**.

**Step 11:** Click **Yes** to continue.

## WAFER-CV-D25501/N26001 3.5" Motherboard



**Figure 6-5: Chipset Driver License Agreement**

**Step 12:** The Read Me file in **Figure 6-6** appears.

**Step 13:** Click **Next** to continue.

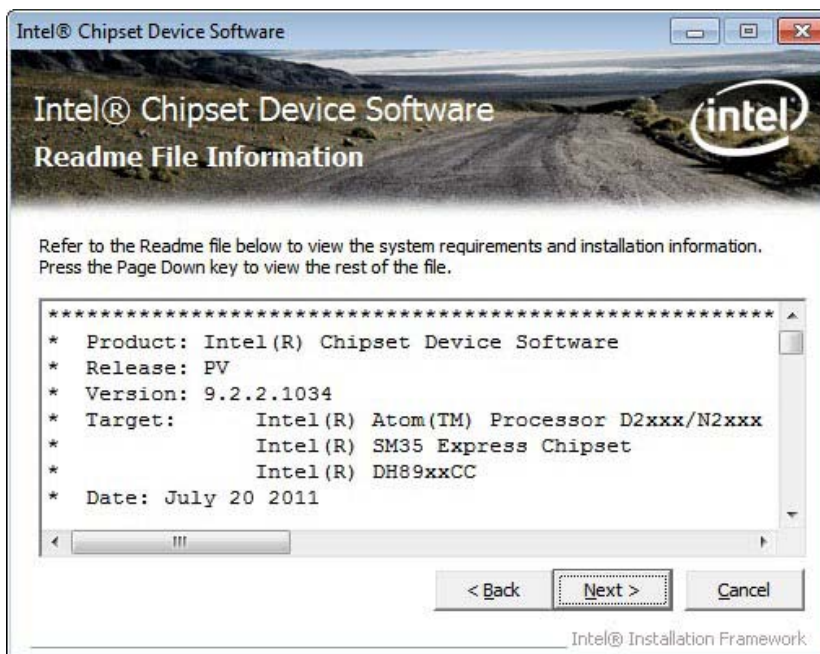

**Figure 6-6: Chipset Driver Read Me File**



**Step 14:** Setup Operations are performed as shown in Figure 6-7.

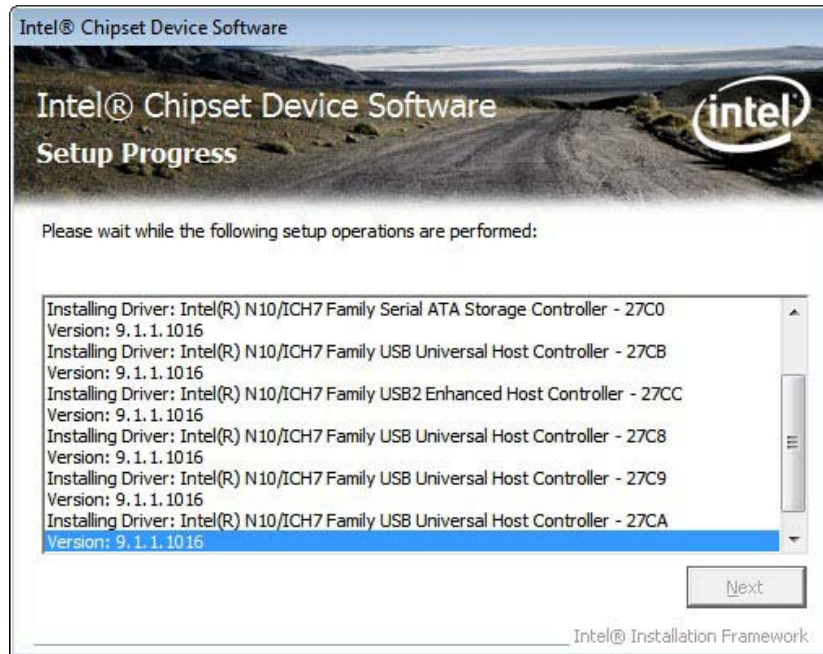

**Figure 6-7: Chipset Driver Setup Operations**

**Step 15:** Once the Setup Operations are complete, click **Next** to continue.

**Step 16:** The **Finish** screen appears.

**Step 17:** Select “**Yes, I want to restart the computer now**” and click the **Finish** icon.

See **Figure 6-8**.



Figure 6-8: Chipset Driver Installation Finish Screen

## 6.4 Graphics Driver Installation



### NOTE:

Due to Intel® GMA driver limitation, the monitor connected to the VGA connector may become extended desktop or not have signal to it after restarting from the graphics driver installation. To work out this limitation, press the Ctrl+Alt+F1 hotkey to switch the primary display to CRT mode.

To install the graphics driver, please do the following.

- Step 1:** Access the driver list. (See **Section 6.2**)
- Step 2:** Click “**2-Graphics**”.
- Step 3:** Open the 32-bit or 64-bit folder that corresponds to your OS version.
- Step 4:** Double click the **Setup** icon.

**Step 5:** The **Welcome Screen** in **Figure 6-9** appears.



**Figure 6-9: Graphics Driver Welcome Screen**

**Step 6:** Click **Next** to continue.

**Step 7:** The license agreement in **Figure 6-10** appears.

**Step 8:** Read the **License Agreement**.

**Step 9:** Click **Yes** to continue.

## WAFER-CV-D25501/N26001 3.5" Motherboard

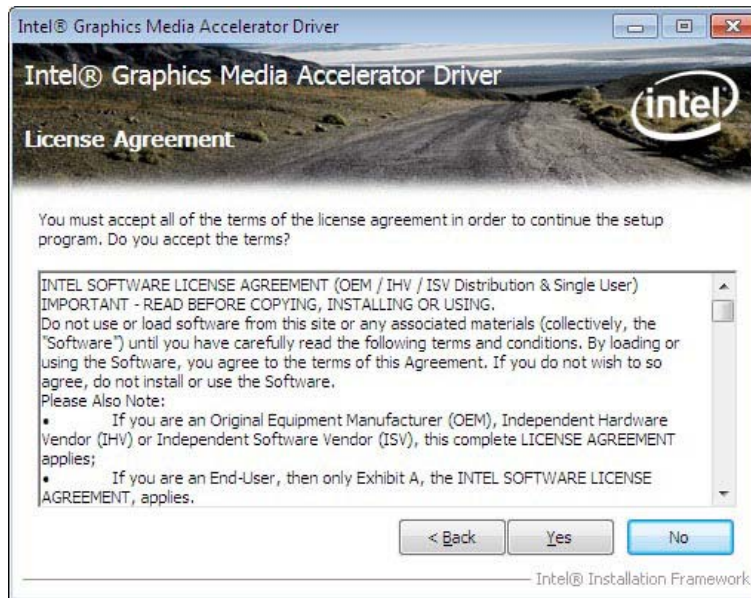

**Figure 6-10: Graphics Driver License Agreement**

**Step 10:** The Read Me file in **Figure 6-11** appears.

**Step 11:** Click **Next** to continue.

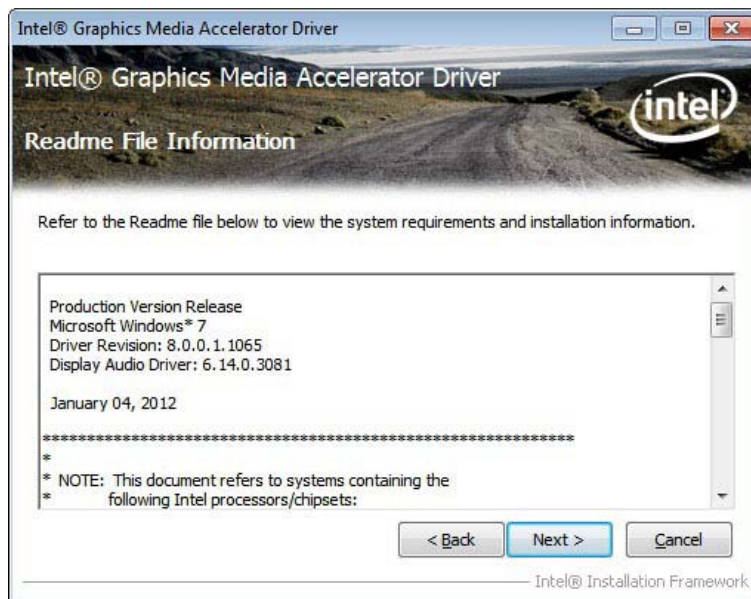

**Figure 6-11: Graphics Driver Read Me File**

**Step 12:** Setup Operations are performed as shown in **Figure 6-12**.

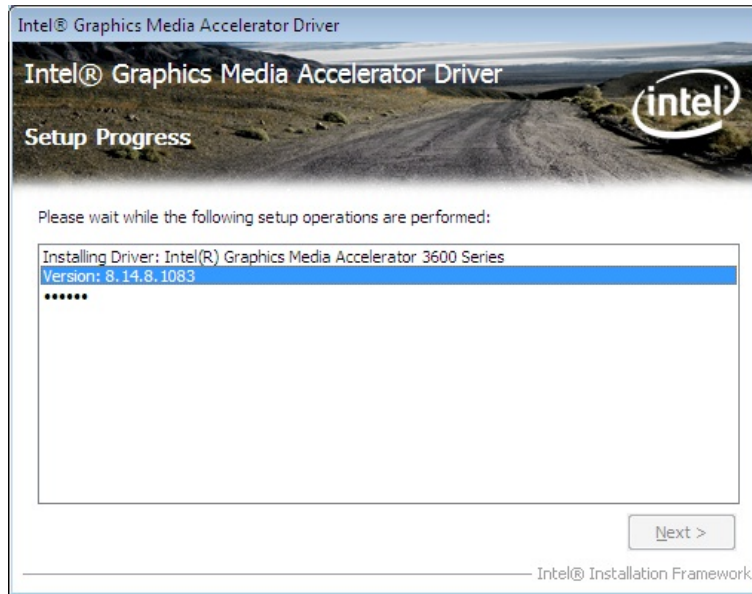

Figure 6-12: Graphics Driver Setup Operations

**Step 13:** Once the **Setup Operations** are complete, click the **Next** icon to continue.

**Step 14:** The **Finish** screen appears.

**Step 15:** Select “Yes, I want to restart the computer now” and click the **Finish** icon.

See **Figure 6-13**.



Figure 6-13: Graphics Driver Installation Finish Screen

## WAFER-CV-D25501/N26001 3.5" Motherboard

### 6.5 LAN Driver Installation

To install the LAN driver, please do the following.

**Step 1:** Access the driver list shown in Figure 6-2. (See **Section 6.2**)

**Step 2:** Click **"3-LAN"**.

**Step 3:** Go to the **Win7 > Install\_Win7\_7048\_09162011** folder.

**Step 4:** Double click the **setup** icon.

**Step 5:** The **Welcome** screen in **Figure 6-14** appears.

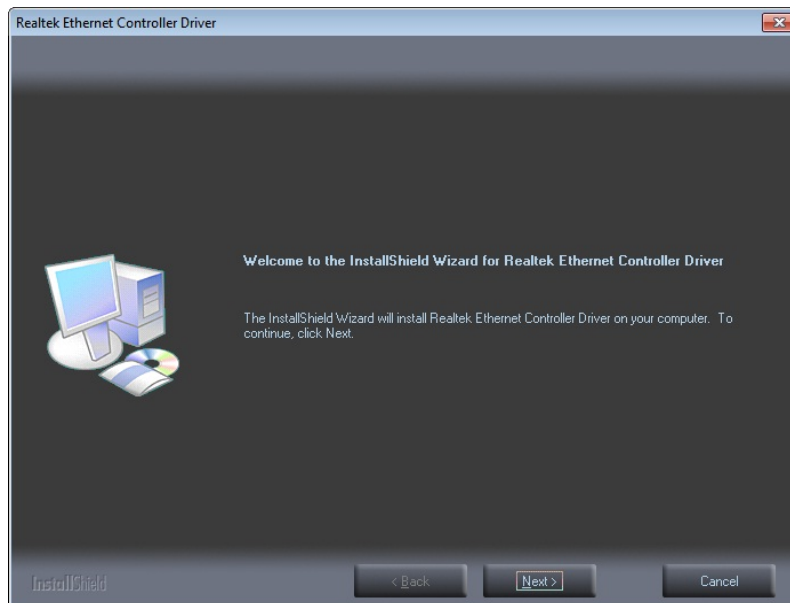

**Figure 6-14: LAN Driver Welcome Screen**

**Step 6:** Click **Next** to continue.

**Step 7:** The **Ready to Install** screen in **Figure 6-15** appears.

**Step 8:** Click **Install** to proceed with the installation.

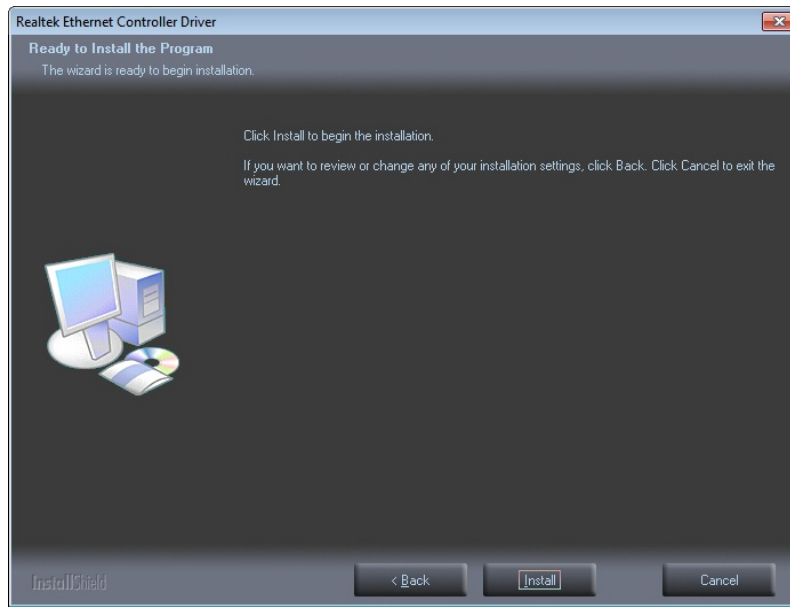

Figure 6-15: LAN Driver Installation

**Step 9:** The program begins to install.

**Step 10:** When the driver installation is complete, the screen in **Figure 6-16** appears.

**Step 11:** Click **Finish** to exit.

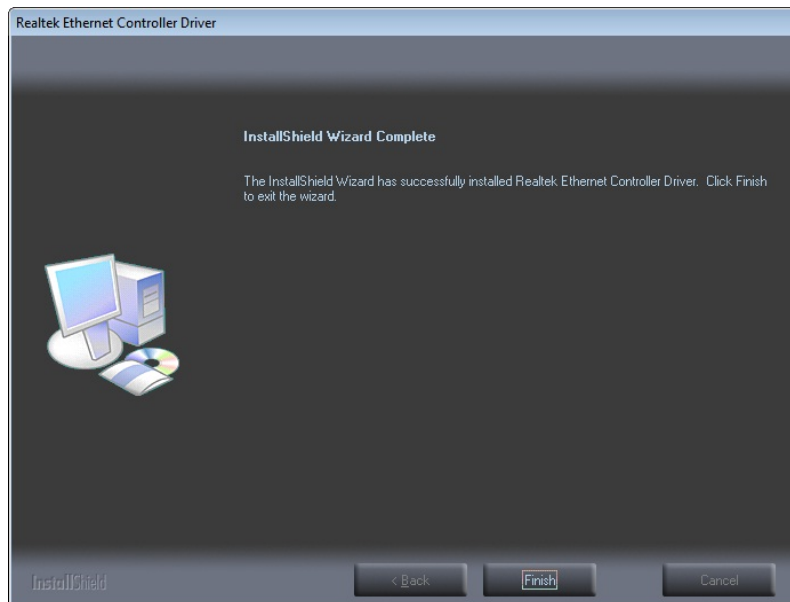

Figure 6-16: LAN Driver Installation Complete

## WAFER-CV-D25501/N26001 3.5" Motherboard

### 6.6 Audio Driver Installation

To install the Audio driver, please do the following.

**Step 1:** Access the driver list. (See **Section 6.2**)

**Step 2:** Click “**4-Audio**”.

**Step 3:** Open the **Win7** folder.

**Step 4:** Double click the **Vista\_Win7\_R263** icon.

**Step 5:** The installation files are extracted as shown in **Figure 6-17**.

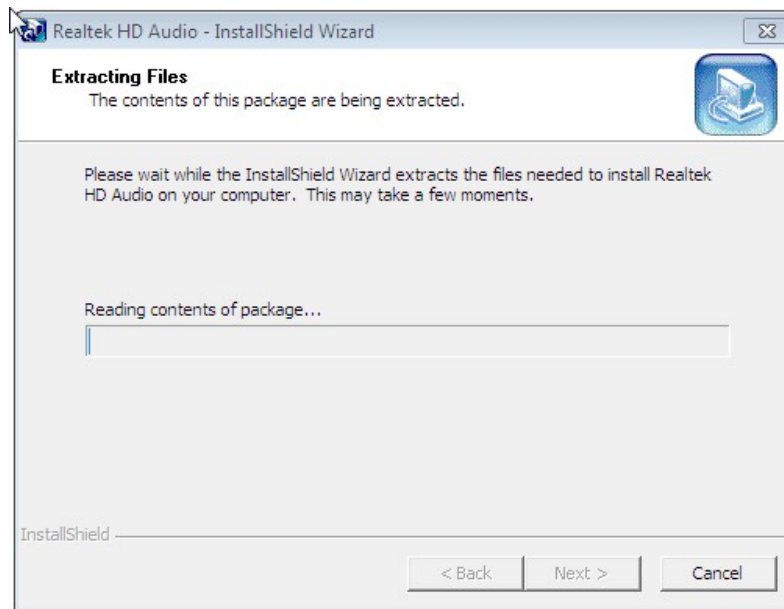

**Figure 6-17: Audio Driver Installation File Extraction**

**Step 6:** The **Welcome** screen in **Figure 6-18** appears.



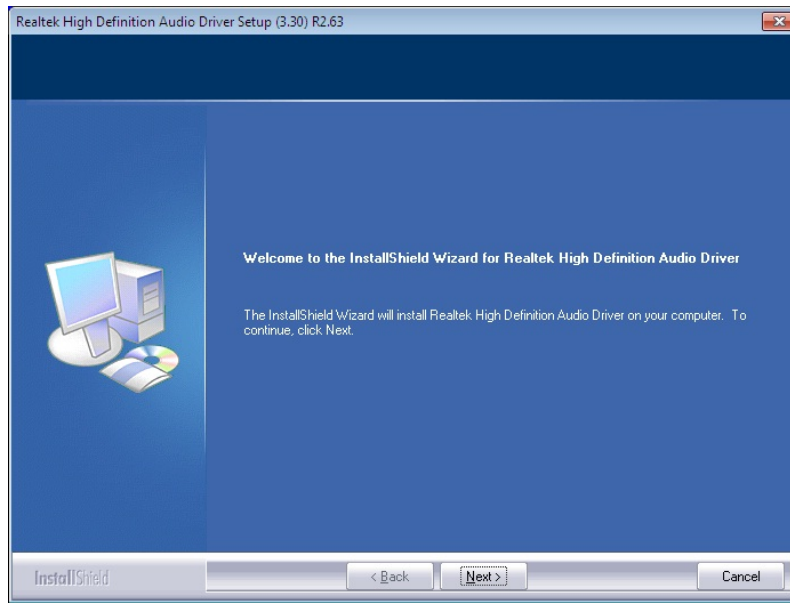

Figure 6-18: Audio Driver Welcome Screen

**Step 7:** Click **Next** to continue.

**Step 8:** The program begins to install.

**Step 9:** The installation progress can be monitored in the progress bar shown in **Figure 6-19**.

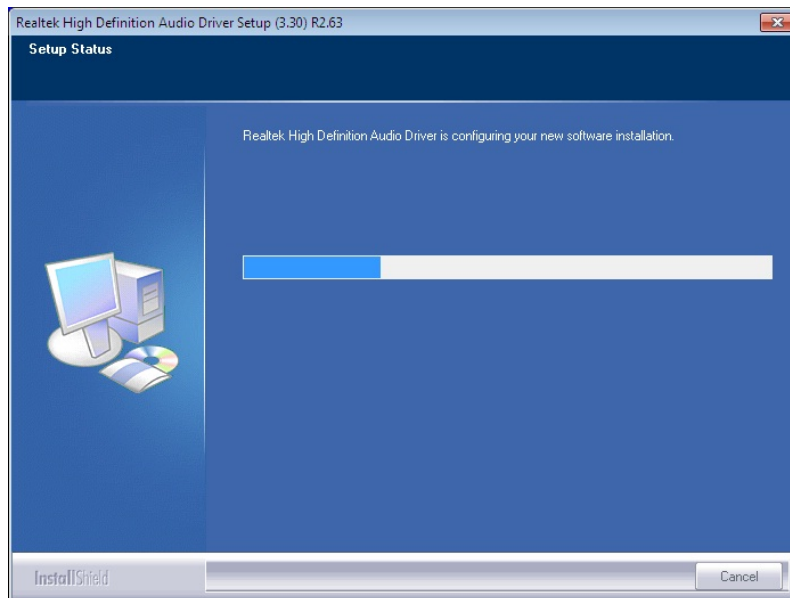
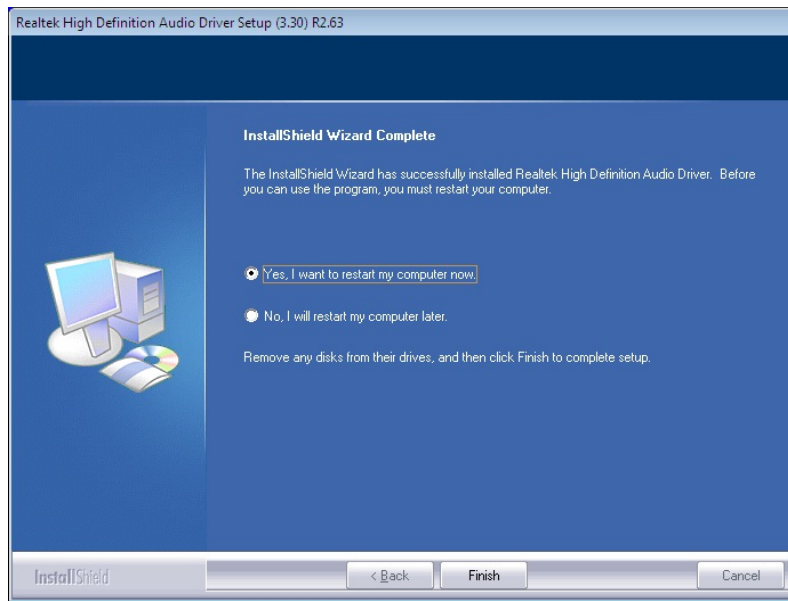

Figure 6-19: Audio Driver Installation

**Step 10:** When the driver installation is complete, the screen in **Figure 6-20** appears.

## WAFER-CV-D25501/N26001 3.5" Motherboard



**Figure 6-20: Audio Driver Installation Complete**

**Step 11:** Select “Yes, I want to restart my computer now” and click **Finish**.

**Step 12:** The system reboots.

Appendix

**A**

# BIOS Options

---

## WAFER-CV-D25501/N26001 3.5" Motherboard

Below is a list of BIOS configuration options in the BIOS chapter.

<b>System Overview</b> .....	<b>67</b>
<b>System Date [xx/xx/xx]</b> .....	<b>67</b>
<b>System Time [xx:xx:xx]</b> .....	<b>68</b>
<b>ACPI Sleep State [S1 (CPU Stop Clock)]</b> .....	<b>69</b>
<b>Wake system with Fixed Time [Disabled]</b> .....	<b>70</b>
<b>Hyper-Threading [Enabled]</b> .....	<b>72</b>
<b>Configure SATA as [IDE]</b> .....	<b>72</b>
<b>Legacy USB Support [Enabled]</b> .....	<b>73</b>
<b>Serial Port [Enabled]</b> .....	<b>75</b>
<b>Change Settings [Auto]</b> .....	<b>75</b>
<b>Serial Port [Enabled]</b> .....	<b>75</b>
<b>Change Settings [Auto]</b> .....	<b>76</b>
<b>Serial Port [Enabled]</b> .....	<b>76</b>
<b>Change Settings [Auto]</b> .....	<b>76</b>
<b>Serial Port [Enabled]</b> .....	<b>77</b>
<b>Change Settings [Auto]</b> .....	<b>77</b>
<b>PC Health Status</b> .....	<b>79</b>
<b>CPU_FAN1/SYS_FAN Smart Fan Control [Auto Duty-Cycle Mode]</b> .....	<b>80</b>
<b>CPU/System Temperature n</b> .....	<b>80</b>
<b>Console Redirection [Disabled]</b> .....	<b>81</b>
<b>Terminal Type [ANSI]</b> .....	<b>81</b>
<b>Bits per second [115200]</b> .....	<b>81</b>
<b>Data Bits [8]</b> .....	<b>82</b>
<b>Parity [None]</b> .....	<b>82</b>
<b>Stop Bits [1]</b> .....	<b>82</b>
<b>Auto Recovery Function [Disabled]</b> .....	<b>83</b>
<b>IGFX - Boot Type [VBIOS Default]</b> .....	<b>86</b>
<b>LVDS1 Panel Type [800x600 LVDS]</b> .....	<b>86</b>
<b>Backlight Control [Inverted]</b> .....	<b>86</b>
<b>Fixed Graphics Memory Size [128MB]</b> .....	<b>86</b>
<b>Power Saving Function(ERP) [Disabled]</b> .....	<b>87</b>
<b>Restore AC Power Loss [Last State]</b> .....	<b>87</b>
<b>Bootup NumLock State [On]</b> .....	<b>88</b>



Quiet Boot [Enabled] .....89  
Launch PXE OpROM [Disabled] .....89  
Option ROM Messages [Force BIOS].....89  
UEFI Boot [Disabled] .....89  
Administrator Password .....90  
User Password .....90  
Save Changes and Reset .....91  
Discard Changes and Reset .....91  
Restore Defaults .....91  
Save as User Defaults .....91  
Restore User Defaults .....91

Appendix

**B**

# One Key Recovery

---

## B.1 One Key Recovery Introduction

The IEI one key recovery is an easy-to-use front end for the Norton Ghost system backup and recovery tool. This tool provides quick and easy shortcuts for creating a backup and reverting to that backup or reverting to the factory default settings.



### NOTE:

The latest One Key Recovery software provides an auto recovery function that allows a system running Microsoft Windows OS to automatically restore from the factory default image after encountering a Blue Screen of Death (BSoD) or a hang for around 10 minutes. Please refer to Section B.3 for the detailed setup procedure.

---

The IEI One Key Recovery tool menu is shown below.

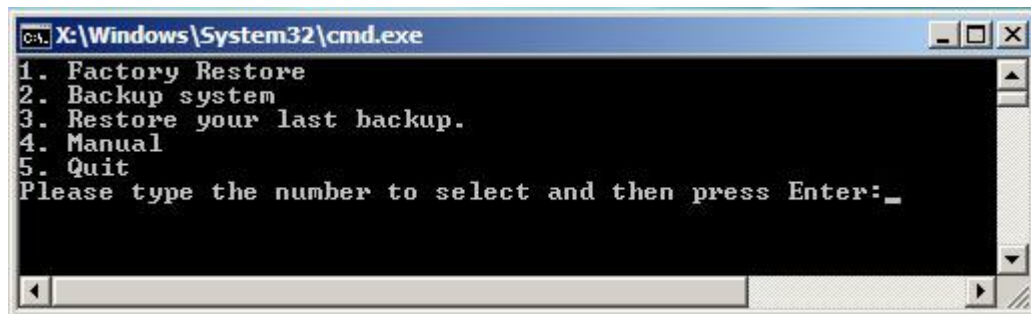

```
C:\X:\Windows\System32\cmd.exe
1. Factory Restore
2. Backup system
3. Restore your last backup.
4. Manual
5. Quit
Please type the number to select and then press Enter: _
```

Figure B-1: IEI One Key Recovery Tool Menu

Prior to using the IEI One Key Recovery tool (as shown in **Figure B-1**) to backup or restore Windows system, five setup procedures are required.

1. Hardware and BIOS setup (see Section **B.2.1**)
2. Create partitions (see **Section B.2.2**)
3. Install operating system, drivers and system applications (see **Section B.2.3**)
4. Build-up recovery partition (see **Section B.2.4**)
5. Create factory default image (see **Section B.2.5**)

## WAFER-CV-D25501/N26001 3.5" Motherboard

After completing the five initial setup procedures as described above, users can access the recovery tool by pressing <F3> while booting up the system. The detailed information of each function is described in **Section B.5**.



### NOTE:

The initial setup procedures for Linux system are described in **Section B.3**.

### B.1.1 System Requirement



### NOTE:

The recovery CD can only be used with IEI products. The software will fail to run and a warning message will appear when used on non-IEI hardware.

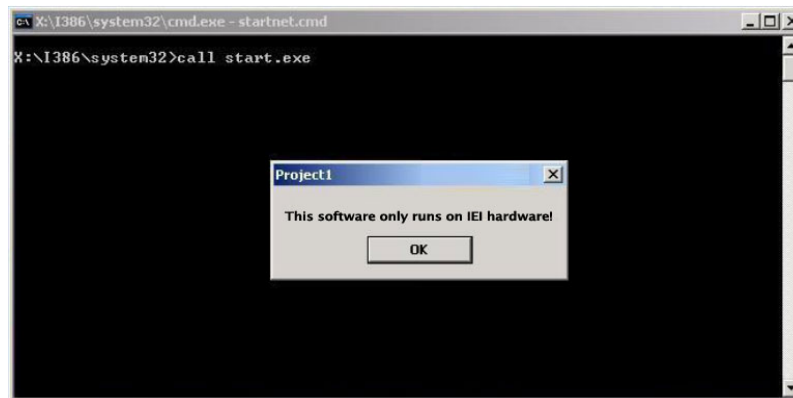

To create the system backup, the main storage device must be split into two partitions (three partitions for Linux). The first partition will be for the operating system, while the second partition will be invisible to the operating system and contain the backup made by the one key recovery software.

The partition created for recovery images must be big enough to contain both the factory default image and the user backup image. The size must be calculated before creating the



partitions. Please take the following table as a reference when calculating the size of the partition.

	OS	OS Image after Ghost	Compression Ratio
<b>Windows® 7</b>	7 GB	5 GB	70%
<b>Windows® XPE</b>	776 MB	560 MB	70%
<b>Windows® CE 6.0</b>	36 MB	28 MB	77%



**NOTE:**

Specialized tools are required to change the partition size if the operating system is already installed.

**B.1.2 Supported Operating System**

The recovery CD is compatible with both Microsoft Windows and Linux operating system (OS). The supported OS versions are listed below.

- Microsoft Windows
  - Windows 2000
  - Windows XP (Service Pack 2 or 3 required)
  - Windows Vista
  - Windows 7
  - Windows CE 5.0
  - Windows CE 6.0
  - Windows XP Embedded
  - Windows Embedded Standard 7



**NOTE:**

The auto recovery function (described in **Section B.3**) and the restore through LAN function (described in **Section B.6**) are not supported in the Windows CE 5.0/6.0 operating system environment.

## WAFER-CV-D25501/N26001 3.5" Motherboard

- Linux
  - Fedora Core 12 (Constantine)
  - Fedora Core 11 (Leonidas)
  - Fedora Core 10 (Cambridge)
  - Fedora Core 8 (Werewolf)
  - Fedora Core 7 (Moonshine)
  - RedHat RHEL-5.4
  - RedHat 9 (Ghirke)
  - Ubuntu 8.10 (Intrepid)
  - Ubuntu 7.10 (Gutsy)
  - Ubuntu 6.10 (Edgy)
  - Debian 5.0 (Lenny)
  - Debian 4.0 (Etch)
  - SuSe 11.2
  - SuSe 10.3



### NOTE:

Installing unsupported OS versions may cause the recovery tool to fail.

---

## B.2 Setup Procedure for Windows

Prior to using the recovery tool to backup or restore, a few setup procedures are required.

**Step 1:** Hardware and BIOS setup (see **Section B.2.1**)

**Step 2:** Create partitions (see **Section B.2.2**)

**Step 3:** Install operating system, drivers and system applications (see **Section B.2.3**)

**Step 4:** Build the recovery partition (see **Section B.2.4**) or build the auto recovery partition (see **Section B.3**)

**Step 5:** Create factory default image (see **Section B.2.5**)

The detailed descriptions are described in the following sections.



#### NOTE:

The setup procedures described below are for Microsoft Windows operating system users. For Linux, most of the setup procedures are the same except for several steps described in **Section B.3**.

### B.2.1 Hardware and BIOS Setup

- Step 1:** Make sure the system is powered off and unplugged.
- Step 2:** Install a hard drive or SSD in the system. An unformatted and unpartitioned disk is recommended.
- Step 3:** Connect an optical disk drive to the system and insert the recovery CD.
- Step 4:** Turn on the system.
- Step 5:** Press the <DELETE> key as soon as the system is turned on to enter the BIOS.
- Step 6:** Select the connected optical disk drive as the 1<sup>st</sup> boot device. (**Boot** → **Boot Device Priority** → **1<sup>st</sup> Boot Device**).
- Step 7:** Save changes and restart the computer. Continue to the next section for instructions on partitioning the internal storage.

### B.2.2 Create Partitions

To create the system backup, the main storage device must be split into two partitions (three partitions for Linux). The first partition will be for the operating system, while the second partition will be invisible to the operating system and contain the backup made by the one key recovery software.

- Step 1:** Put the recovery CD in the optical drive of the system.

## WAFER-CV-D25501/N26001 3.5" Motherboard

**Step 2:** Boot the system from recovery CD. When prompted, press any key to boot from the recovery CD. It will take a while to launch the recovery tool. Please be patient!

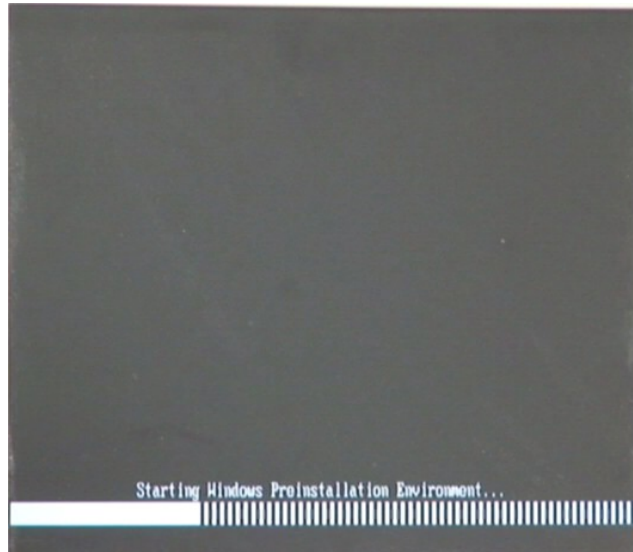

Figure B-2: Launching the Recovery Tool

**Step 3:** The recovery tool setup menu is shown as below.

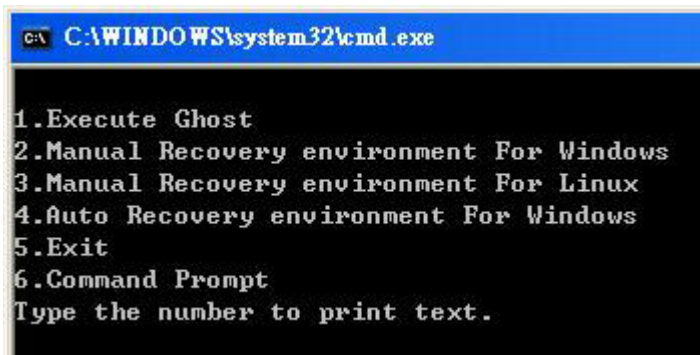
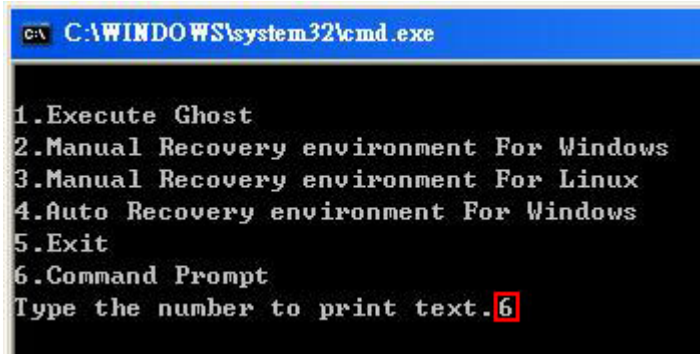

Figure B-3: Recovery Tool Setup Menu

**Step 4:** Press <6> then <Enter>.



```
C:\WINDOWS\system32\cmd.exe

1.Execute Ghost
2.Manual Recovery environment For Windows
3.Manual Recovery environment For Linux
4.Auto Recovery environment For Windows
5.Exit
6.Command Prompt
Type the number to print text.6
```

Figure B-4: Command Prompt

**Step 5:** The command prompt window appears. Type the following commands (marked in red) to create two partitions. One is for the OS installation; the other is for saving recovery files and images which will be an invisible partition. (Press <Enter> after entering each line below)

```
system32>diskpart
DISKPART>list vol
DISKPART>sel disk 0
DISKPART>create part pri size= ____
DISKPART>assign letter=N
DISKPART>create part pri size= ____
DISKPART>assign letter=F
DISKPART>exit
system32>format N: /fs:ntfs /q /y
system32>format F: /fs:ntfs /q /v:Recovery /y
system32>exit
```

```

X:\I386\SYSTEM32\CMD.EXE
X:\I386\SYSTEM32>diskpart → Starts the Microsoft disk partitioning tool.

Microsoft DiskPart version 5.2.3790.1830
Copyright (C) 1999-2001 Microsoft Corporation.
On computer: MININT-JUC

DISKPART> list vol → Show partition information

   Volume ###  Ltr  Label          Fs      Type          Size      Status       Info
   -----  -  -  -  -  -  -  -  -
   Volume 0             X  CD_ROM         CDFS    DUD-ROM       405 MB    Healthy      Boot
   Volume 1             D                FAT32    Removeable   3854 MB    Healthy

DISKPART> sel disk 0 → Select a disk
Disk 0 is now the selected disk.

DISKPART> create part pri size=2000 → Create partition 1 and assign a size.
                                     This partition is for OS installation.
DiskPart succeeded in creating the specified partition.

DISKPART> assign letter=N → Assign partition 1 a code name (N).
DiskPart successfully assigned the drive letter or mount point.

DISKPART> create part pri size=1800 → Create partition 2 and assign a size.
                                     This partition is for recovery images.
DiskPart succeeded in creating the specified partition.

DISKPART> assign letter=F → Assign partition 2 a code name (F).
DiskPart successfully assigned the drive letter or mount point.

DISKPART> exit → Exit diskpart

X:\I386\SYSTEM32>format n: /fs:ntfs /q /y → Format partition 1 (N) as NTFS format.
The type of the file system is RAW.
The new file system is NTFS.
QuickFormatting 2000M
Creating file system structures.
Format complete.
 2048254 KB total disk space.
 2035620 KB are available.

X:\I386\SYSTEM32>format f: /fs:ntfs /q /v:Recovery /y → Formate partition 2 (F) as NTFS formate and
                                                         name it as "Recovery".
The type of the file system is RAW.
The new file system is NTFS.
QuickFormatting 1804M
Creating file system structures.
Format complete.
 1847474 KB total disk space.
 1835860 KB are available.

X:\I386\SYSTEM32>exit → Exit Windows PE
  
```

Figure B-5: Partition Creation Commands

**NOTE:**

Use the following commands to check if the partitions were created successfully.

```
X:\I386\SYSTEM32>diskpart
Microsoft DiskPart version 5.2.3790.1830
Copyright (C) 1999-2001 Microsoft Corporation.
On computer: MININT-JUC

DISKPART> sel disk 0
Disk 0 is now the selected disk.

DISKPART> list part

   Partition ###   Type              Size              Offset
-----
   Partition 1     Primary           2000 MB           32 KB
   Partition 2     Primary           1804 MB           2000 MB

DISKPART> exit
```

**Step 6:** Press any key to exit the recovery tool and automatically reboot the system.

Please continue to the following procedure: Build the Recovery Partition.

### B.2.3 Install Operating System, Drivers and Applications

Install the operating system onto the unlabelled partition. The partition labeled "Recovery" is for use by the system recovery tool and should not be used for installing the operating system or any applications.

**NOTE:**

The operating system installation program may offer to reformat the chosen partition. DO NOT format the partition again. The partition has already been formatted and is ready for installing the new operating system.

To install the operating system, insert the operating system installation CD into the optical drive. Restart the computer and follow the installation instructions.

## WAFER-CV-D25501/N26001 3.5" Motherboard

### B.2.4 Build-up Recovery Partition

- Step 1:** Put the recover CD in the optical drive.
- Step 2:** Start the system.
- Step 3:** **Boot the system from the recovery CD.** When prompted, press any key to boot from the recovery CD. It will take a while to launch the recovery tool. Please be patient!

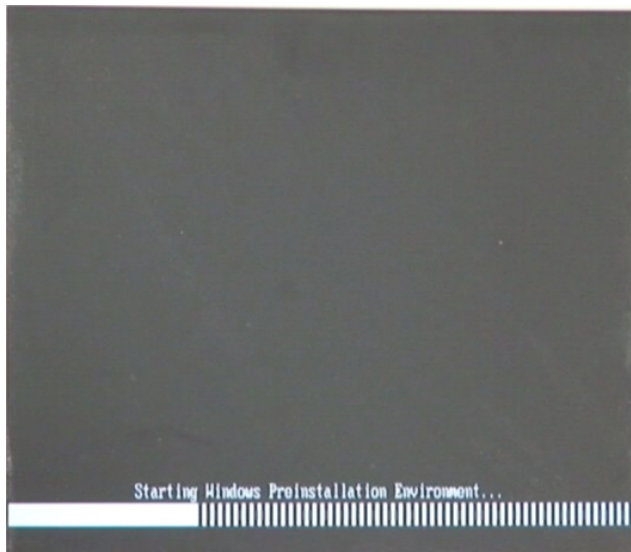

Figure B-6: Launching the Recovery Tool

- Step 4:** When the recovery tool setup menu appears, press <2> then <Enter>.

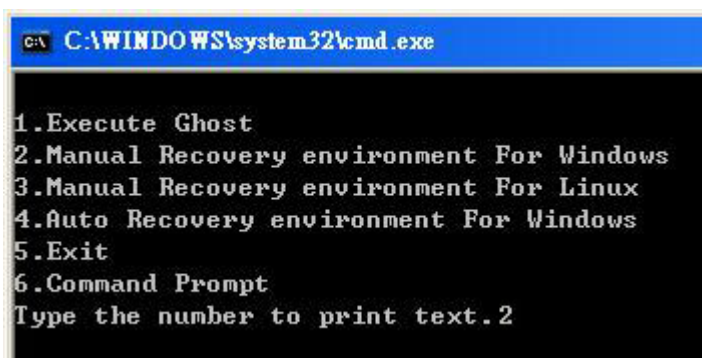
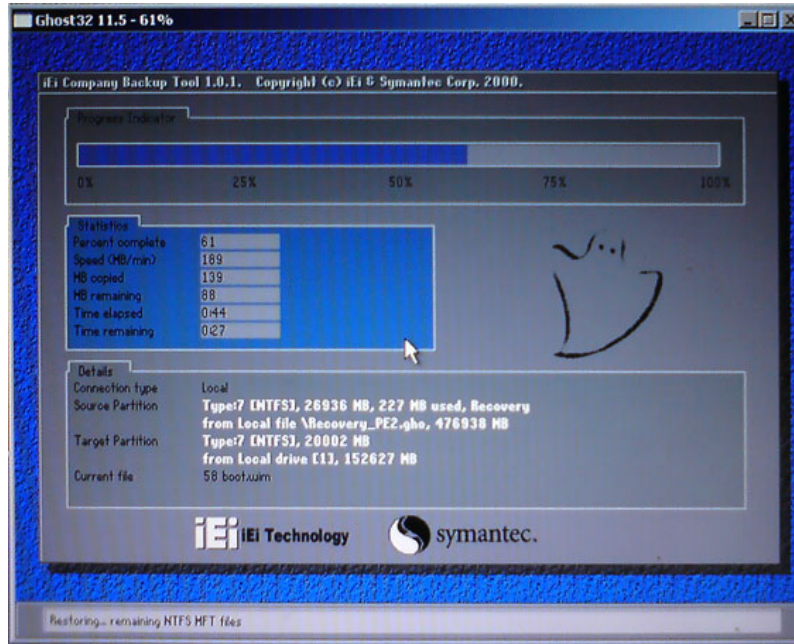

Figure B-7: Manual Recovery Environment for Windows



**Step 5:** The Symantec Ghost window appears and starts configuring the system to build a recovery partition. In this process the partition created for recovery files in **Section B.2.2** is hidden and the recovery tool is saved in this partition.



**Figure B-8: Building the Recovery Partition**

**Step 6:** After completing the system configuration, press any key in the following window to reboot the system.

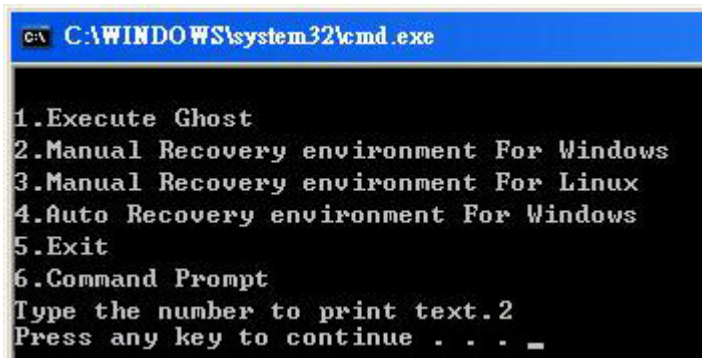

**Figure B-9: Press Any Key to Continue**

**Step 7:** Eject the recovery CD.

## WAFER-CV-D25501/N26001 3.5" Motherboard

### B.2.5 Create Factory Default Image



#### NOTE:

Before creating the factory default image, please configure the system to a factory default environment, including driver and application installations.

To create a factory default image, please follow the steps below.

**Step 1:** Turn on the system. When the following screen displays (**Figure B-10**), press the <F3> key to access the recovery tool. The message will display for 10 seconds, please press F3 before the system boots into the operating system.

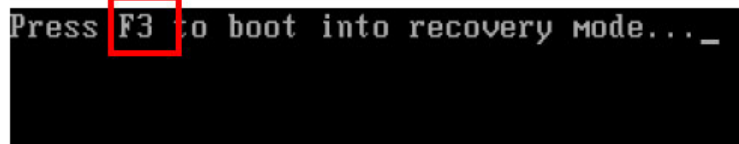

```
Press F3 to boot into recovery mode... _
```

Figure B-10: Press F3 to Boot into Recovery Mode

**Step 2:** The recovery tool menu appears. Type <4> and press <Enter>. (**Figure B-11**)

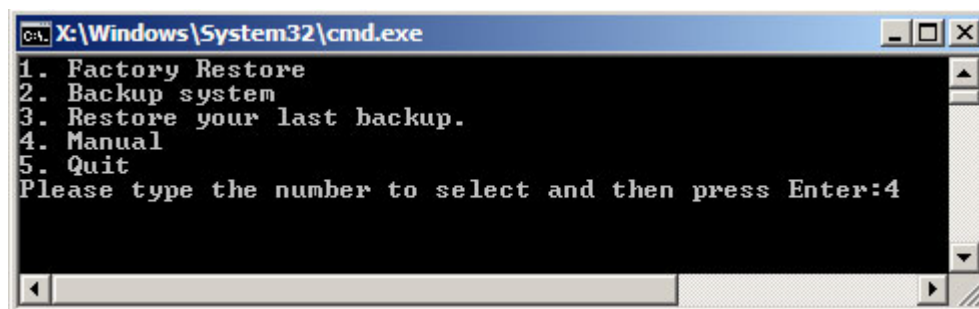

Figure B-11: Recovery Tool Menu

**Step 3:** The About Symantec Ghost window appears. Click **OK** button to continue.

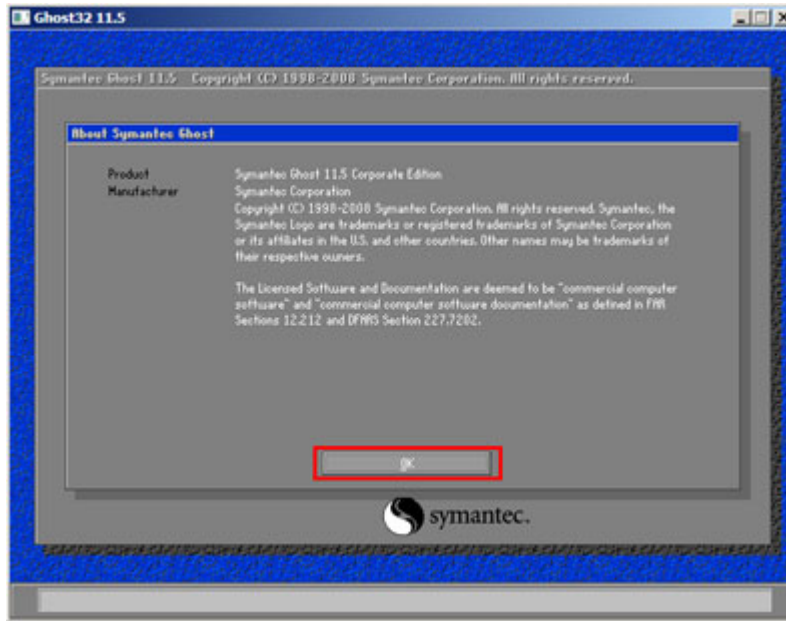

Figure B-12: About Symantec Ghost Window

**Step 4:** Use mouse to navigate to the option shown below (Figure B-13).

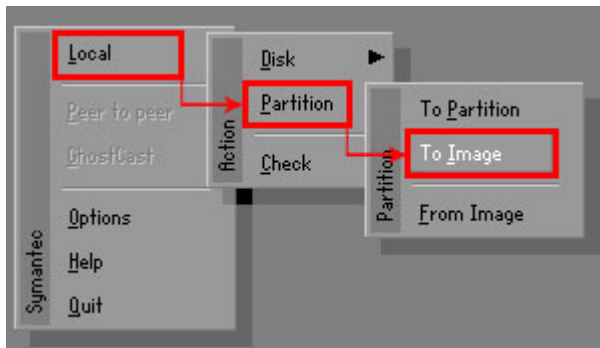
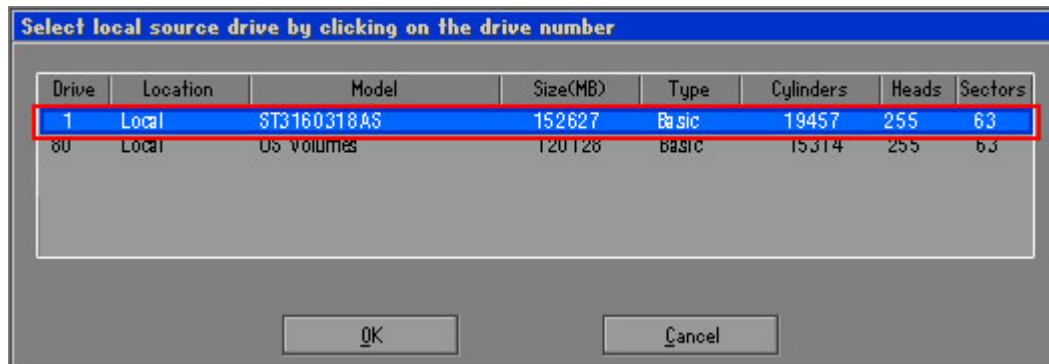

Figure B-13: Symantec Ghost Path

**Step 5:** Select the local source drive (Drive 1) as shown in Figure B-14. Then click OK.

## WAFER-CV-D25501/N26001 3.5" Motherboard



**Figure B-14: Select a Local Source Drive**

**Step 6:** Select a source partition (Part 1) from basic drive as shown in **Figure B-15**. Then click OK.

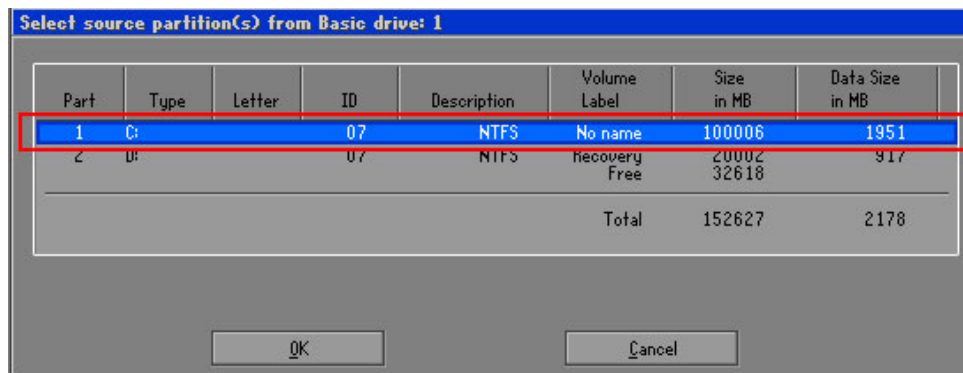

**Figure B-15: Select a Source Partition from Basic Drive**

**Step 7:** Select **1.2: [Recovery] NTFS drive** and enter a file name called **iei** (**Figure B-16**). Click **Save**. The factory default image will then be saved in the selected recovery drive and named **IEI.GHO**.



### WARNING:

The file name of the factory default image must be **iei.GHO**.

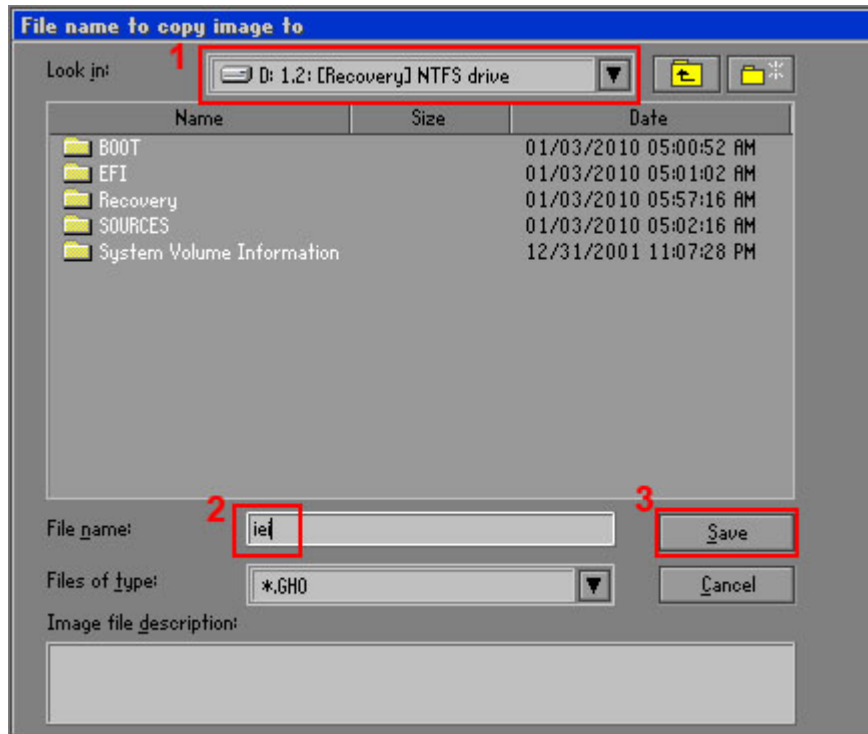

Figure B-16: File Name to Copy Image to

**Step 8:** When the Compress Image screen in **Figure B-17** prompts, click **High** to make the image file smaller.

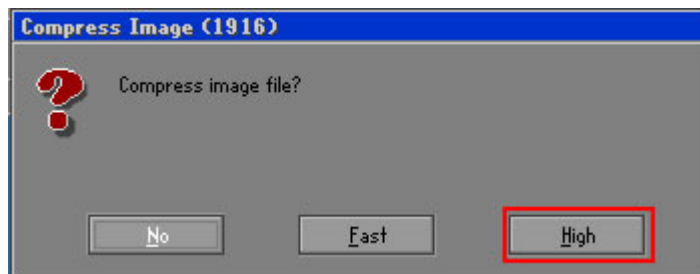
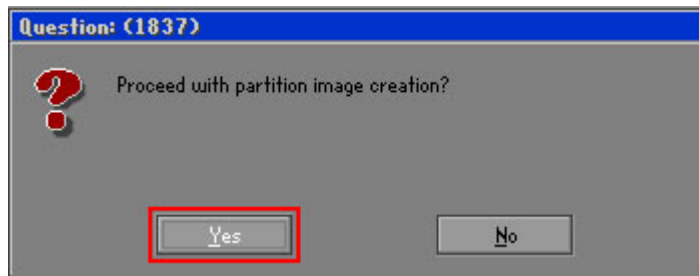

Figure B-17: Compress Image

## WAFER-CV-D25501/N26001 3.5" Motherboard

**Step 9:** The Proceed with partition image creation window appears, click **Yes** to continue.



**Figure B-18: Image Creation Confirmation**

**Step 10:** The Symantec Ghost starts to create the factory default image (**Figure B-19**).

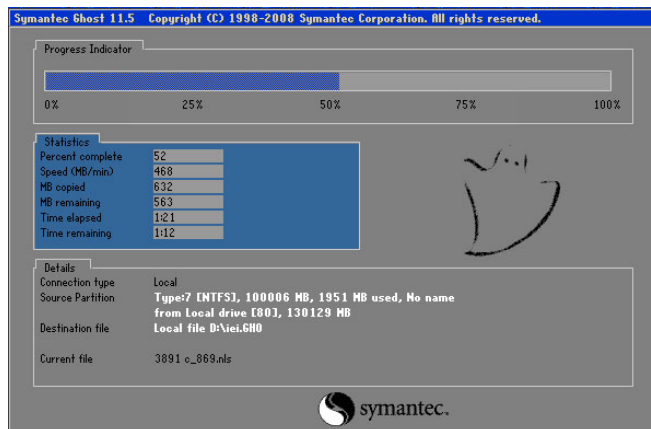

**Figure B-19: Image Creation Complete**

**Step 11:** When the image creation completes, a screen prompts as shown in **Figure B-20**.

Click **Continue** and close the Ghost window to exit the program.



**Figure B-20: Image Creation Complete**

**Step 12:** The recovery tool main menu window is shown as below. Press any key to reboot the system.

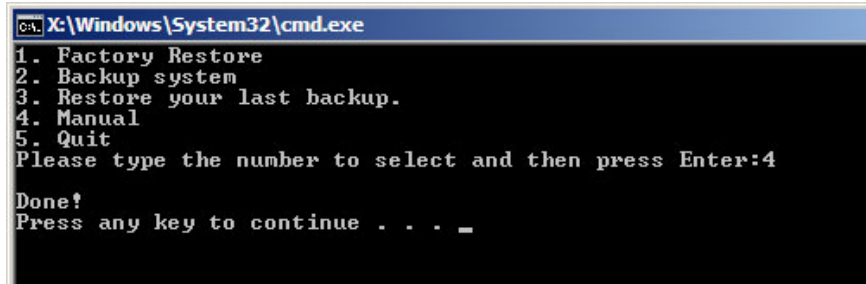

```

C:\Windows\System32\cmd.exe
1. Factory Restore
2. Backup system
3. Restore your last backup.
4. Manual
5. Quit
Please type the number to select and then press Enter:4
Done!
Press any key to continue . . . _
  
```

Figure B-21: Press Any Key to Continue

### B.3 Auto Recovery Setup Procedure

The auto recovery function allows a system to automatically restore from the factory default image after encountering a Blue Screen of Death (BSoD) or a hang for around 10 minutes. To use the auto recovery function, follow the steps described in the following sections.



**CAUTION:**

The auto recovery function can only run on a Microsoft Windows system with the following OS versions:

- Windows 2000
- Windows XP
- Windows Vista
- Windows 7
- Windows XP Embedded
- Windows Embedded Standard 7



**CAUTION:**

The setup procedure may include a step to create a factory default image. It is suggested to configure the system to a factory default environment before the configuration, including driver and application installations.

## WAFER-CV-D25501/N26001 3.5" Motherboard

- Step 1:** Follow the steps described in **Section B.2.1 ~ Section B.2.3** to setup BIOS, create partitions and install operating system.
- Step 2:** Install the auto recovery utility into the system by double clicking the **Utility/AUTORECOVERY-SETUP.exe** in the One Key Recovery CD. This utility **MUST** be installed in the system, otherwise, the system will automatically restore from the factory default image every ten (10) minutes.



**Figure B-22: Auto Recovery Utility**

- Step 3:** **Disable the automatically restart function before creating the factory default image.** Go to: My Computer → Properties → Advanced. Click the Settings button of Startup and Recovery. Deselect “Automatically restart”. Click OK to save the settings and exit. (See **Figure B-23**)

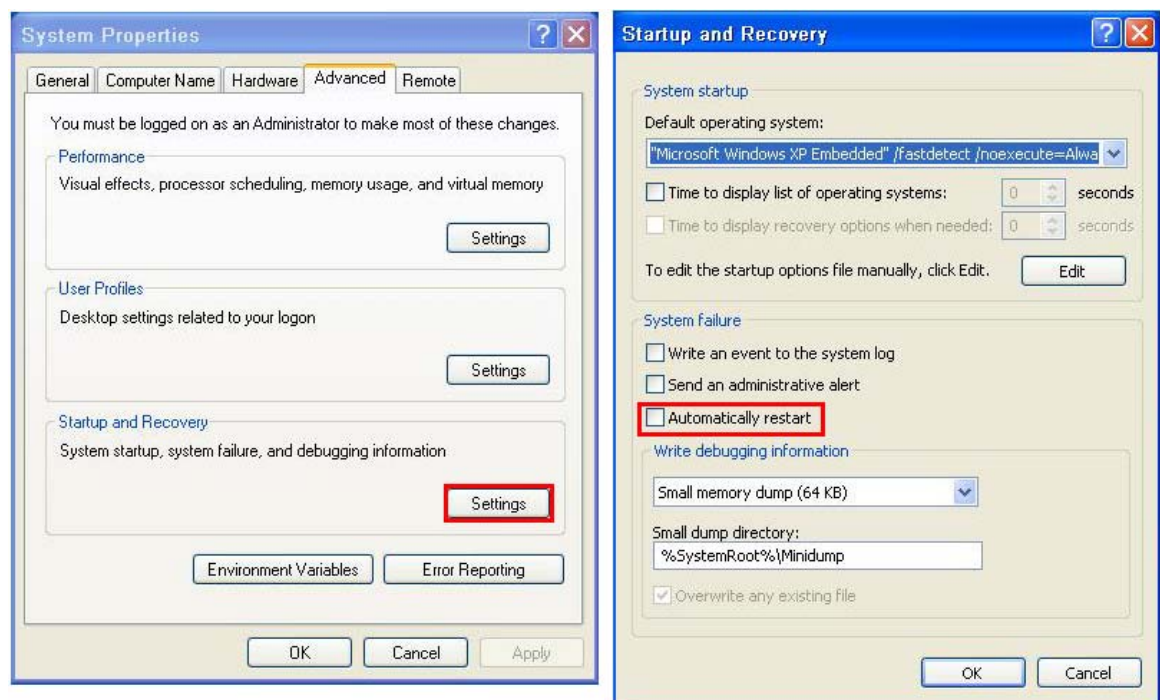

**Figure B-23: Disable Automatically Restart**



**Step 4:** Reboot the system from the recovery CD. When prompted, press any key to boot from the recovery CD. It will take a while to launch the recovery tool. Please be patient!

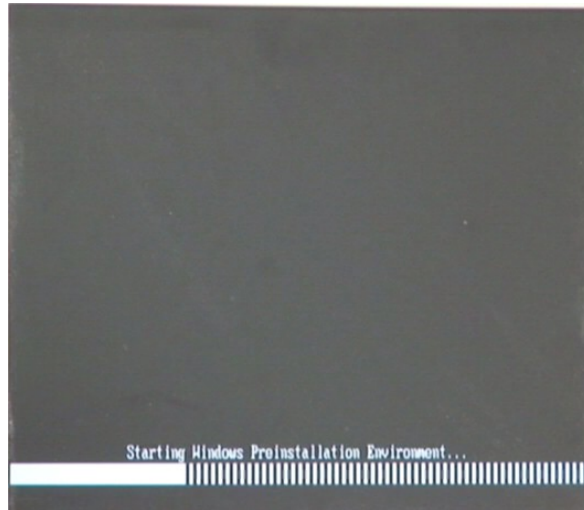

**Figure B-24: Launching the Recovery Tool**

**Step 5:** When the recovery tool setup menu appears, press <4> then <Enter>.

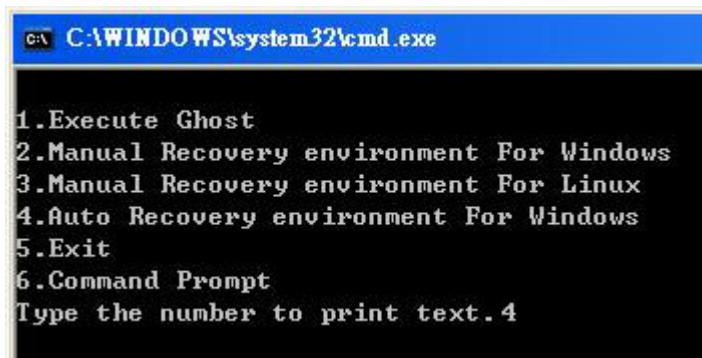

**Figure B-25: Auto Recovery Environment for Windows**

**Step 6:** The Symantec Ghost window appears and starts configuring the system to build an auto recovery partition. In this process the partition created for recovery files in **Section B.2.2** is hidden and the auto recovery tool is saved in this partition.

## WAFER-CV-D25501/N26001 3.5" Motherboard

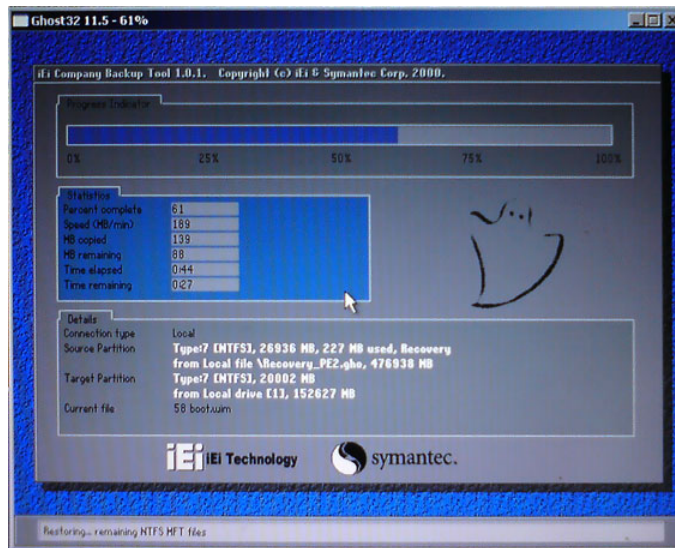

**Figure B-26: Building the Auto Recovery Partition**

**Step 7:** After completing the system configuration, the following message prompts to confirm whether to create a factory default image. Type **Y** to have the system create a factory default image automatically. Type **N** within 6 seconds to skip this process (The default option is YES). It is suggested to choose YES for this option.



**Figure B-27: Factory Default Image Confirmation**

**Step 8:** The Symantec Ghost starts to create the factory default image (**Figure B-28**).

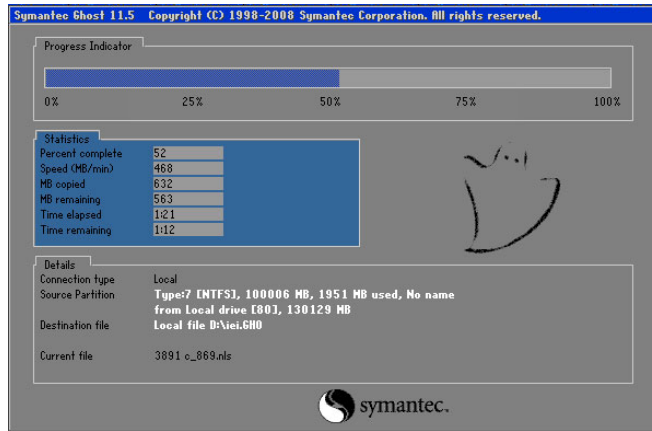

**Figure B-28: Image Creation Complete**

**Step 9:** After completing the system configuration, press any key in the following window to restart the system.

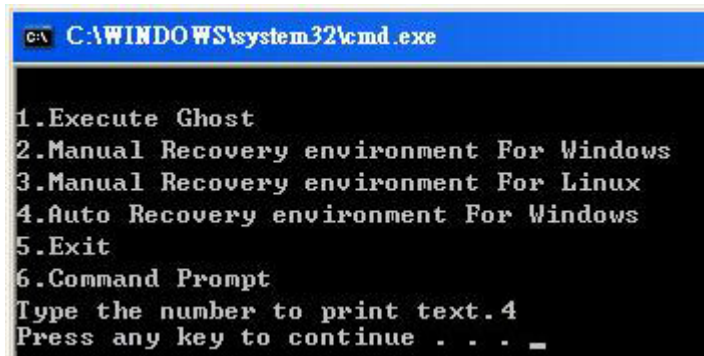

**Figure B-29: Press any key to continue**

**Step 10:** Eject the One Key Recovery CD and restart the system.

**Step 11:** Press the <DELETE> key as soon as the system is turned on to enter the BIOS.

**Step 12:** Enable the Auto Recovery Function option (**Advanced** → **iEi Feature** → **Auto Recovery Function**).

## WAFER-CV-D25501/N26001 3.5" Motherboard

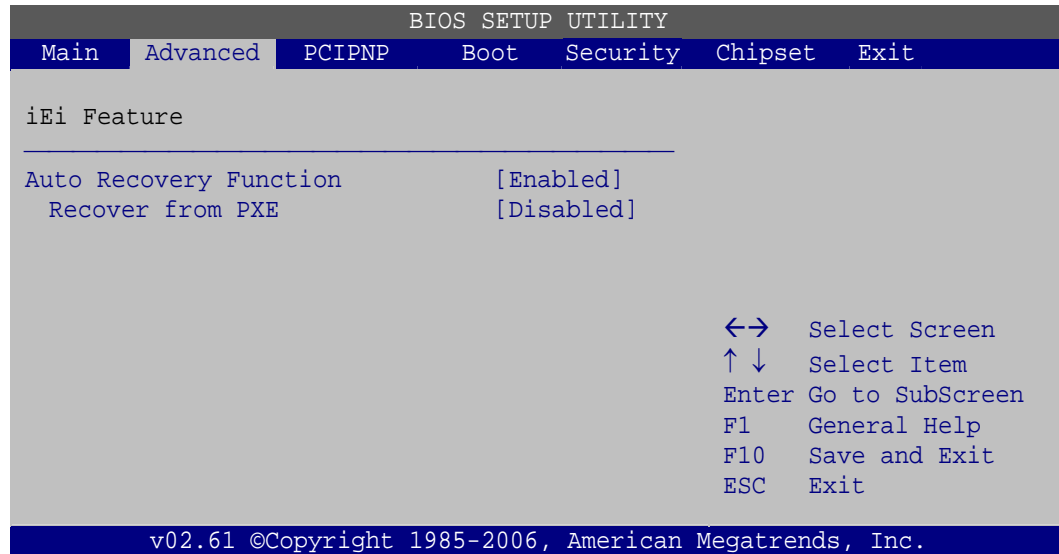

**Figure B-30: IEI Feature**

**Step 13:** Save changes and restart the system. If the system encounters a Blue Screen of Death (BSoD) or a hang for around 10 minutes, it will automatically restore from the factory default image.

## B.4 Setup Procedure for Linux

The initial setup procedures for a Linux system are mostly the same with the procedure for Microsoft Windows. Please follow the steps below to setup the recovery tool for Linux OS.

**Step 1:** Hardware and BIOS setup. Refer to **Section B.2.1**.

**Step 2: Install Linux operating system.** Make sure to install GRUB (v0.97 or earlier) MBR type and Ext3 partition type. Leave enough space on the hard drive to create the recover partition later.



### NOTE:

If the Linux OS is not installed with GRUB (v0.97 or earlier) and Ext3, the Symantec Ghost may not function properly.

While installing Linux OS, please create two partitions:

- Partition 1: /
- Partition 2: SWAP



**NOTE:**

Please reserve enough space for partition 3 for saving recovery images.

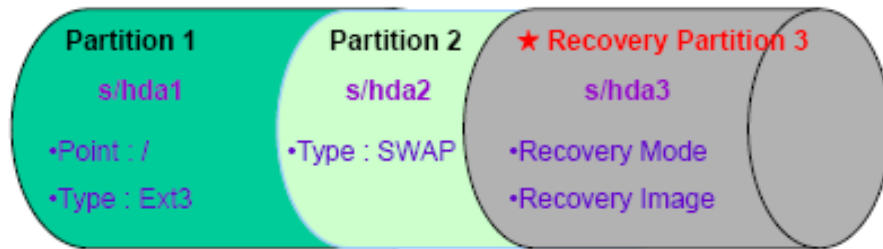

Figure B-31: Partitions for Linux

**Step 3:** Create a recovery partition. Insert the recovery CD into the optical disk drive.

Follow **Step 1 ~ Step 3** described in **Section B.2.2**. Then type the following commands (marked in red) to create a partition for recovery images.

```

system32>diskpart
DISKPART>list vol
DISKPART>sel disk 0
DISKPART>create part pri size= ____
DISKPART>assign letter=N
DISKPART>exit
system32>format N: /fs:ntfs /q /v:Recovery /y
system32>exit
    
```

**Step 4:** Build-up recovery partition. Press any key to boot from the recovery CD. It will take a while to launch the recovery tool. Please be patient. When the recovery tool setup menu appears, type <3> and press <Enter> (**Figure B-32**). The Symantec Ghost window appears and starts configuring the system to build-up a

## WAFER-CV-D25501/N26001 3.5" Motherboard

recovery partition. After completing the system configuration, press any key to reboot the system. Eject the recovery CD.

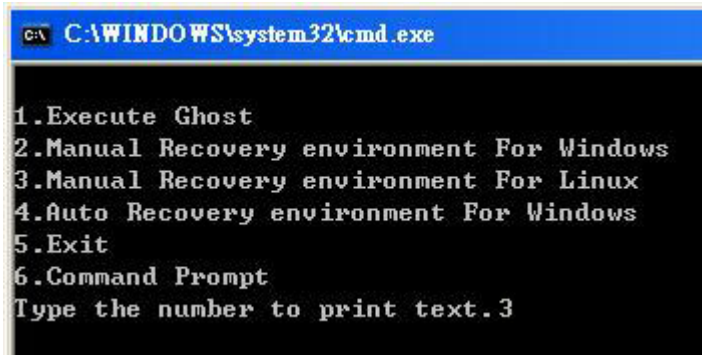

```
C:\WINDOWS\system32\cmd.exe

1.Execute Ghost
2.Manual Recovery environment For Windows
3.Manual Recovery environment For Linux
4.Auto Recovery environment For Windows
5.Exit
6.Command Prompt
Type the number to print text.3
```

Figure B-32: System Configuration for Linux

**Step 5:** Access the recovery tool main menu by modifying the “menu.lst”. To first access the recovery tool main menu, the menu.lst must be modified. In Linux, enter Administrator (root). When prompt appears, type:

```
cd /boot/grub
```

```
vi menu.lst
```

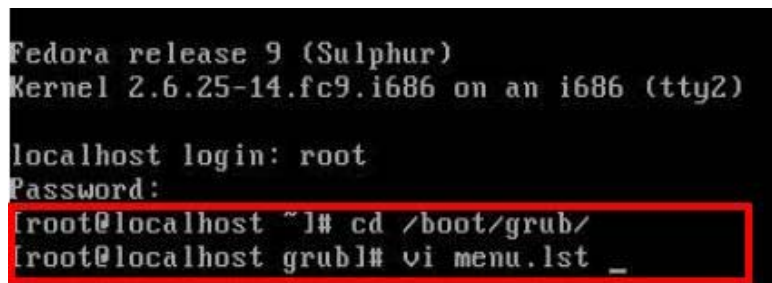

```
Fedora release 9 (Sulphur)
Kernel 2.6.25-14.fc9.i686 on an i686 (tty2)

localhost login: root
Password:
[root@localhost ~]# cd /boot/grub/
[root@localhost grub]# vi menu.lst _
```

Figure B-33: Access menu.lst in Linux (Text Mode)

**Step 6:** Modify the menu.lst as shown below.

```
#boot=/dev/sda
default=0
timeout=10
splashimage=(hd0,0)/grub/splash.xpm.gz
hiddenmenu
title Fedora (2.6.25-14.fc9.i686)
    root (hd0,0)
    kernel /vmlinuz-2.6.25-14.fc9.i686 ro root=UUID=10f1acd
ac38b5c78910 rhgb quiet
    initrd /initrd-2.6.25-14.fc9.i686.img

title Recovery Partition
    root (hd0,2)
    makeactive
    chainloader +1
```

- **Type command:**  
**title Recovery Partition**  
**root (hd0,2)**  
**makeactive**  
**chainloader +1**

**Step 7:** The recovery tool menu appears. (Figure B-34)

```
1. Factory Restore
2. Backup system
3. Restore your last backup.
4. Manual
5. Quit
Please type the number to select and then press Enter:
```

**Figure B-34: Recovery Tool Menu**

**Step 8:** Create a factory default image. Follow **Step 2 ~ Step 12** described in **Section B.2.5** to create a factory default image.

## B.5 Recovery Tool Functions

After completing the initial setup procedures as described above, users can access the recovery tool by pressing **<F3>** while booting up the system. However, if the setup procedure in Section B.3 has been completed and the auto recovery function is enabled, the system will automatically restore from the factory default image without pressing the F3 key. The recovery tool main menu is shown below.

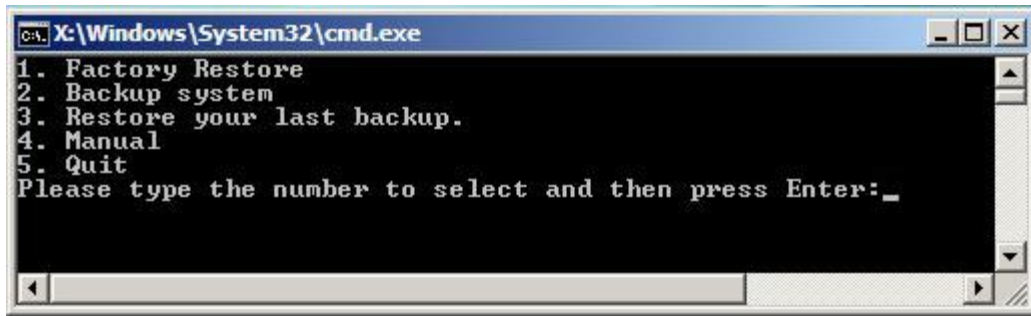

**Figure B-35: Recovery Tool Main Menu**

The recovery tool has several functions including:

1. **Factory Restore:** Restore the factory default image (iei.GHO) created in **Section B.2.5**.
2. **Backup system:** Create a system backup image (iei\_user.GHO) which will be saved in the hidden partition.
3. **Restore your last backup:** Restore the last system backup image
4. **Manual:** Enter the Symantec Ghost window to configure manually.
5. **Quit:** Exit the recovery tool and restart the system.



**WARNING:**

Please do not turn off the system power during the process of system recovery or backup.



**WARNING:**

All data in the system will be deleted during the system recovery. Please backup the system files before restoring the system (either Factory Restore or Restore Backup).



### B.5.1 Factory Restore

To restore the factory default image, please follow the steps below.

**Step 1:** Type <1> and press <Enter> in the main menu.

**Step 2:** The Symantec Ghost window appears and starts to restore the factory default. A factory default image called **iei.GHO** is created in the hidden Recovery partition.

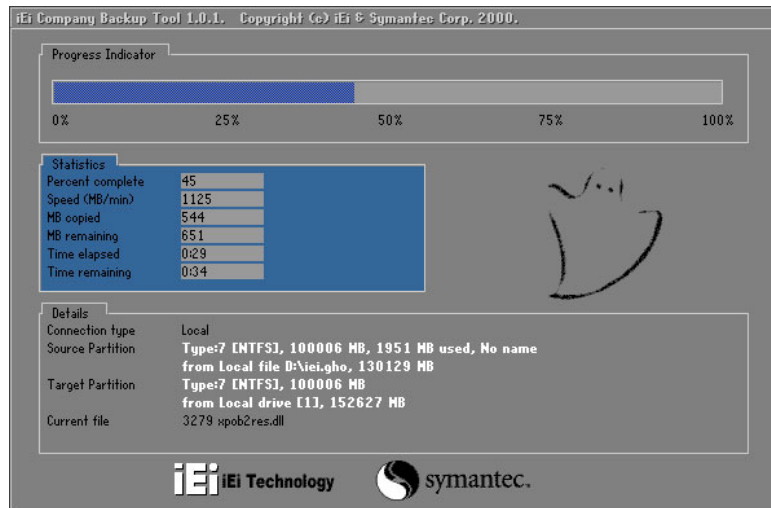

**Figure B-36: Restore Factory Default**

**Step 3:** The screen is shown in **Figure B-37** appears when completed. Press any key to reboot the system.

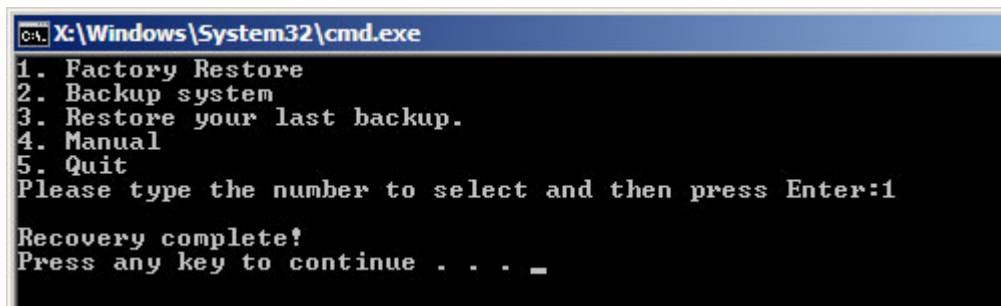

**Figure B-37: Recovery Complete Window**

## WAFER-CV-D25501/N26001 3.5" Motherboard

### B.5.2 Backup System

To backup the system, please follow the steps below.

**Step 1:** Type <2> and press <Enter> in the main menu.

**Step 2:** The Symantec Ghost window appears and starts to backup the system. A backup image called `iei_user.GHO` is created in the hidden Recovery partition.

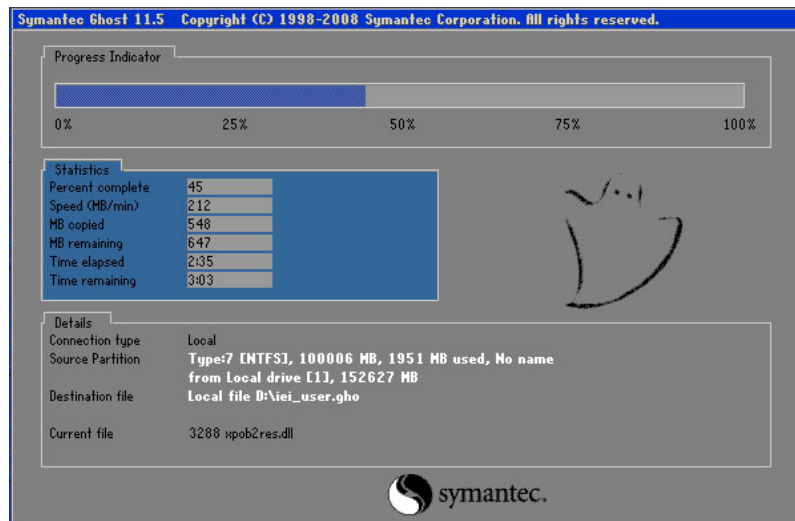

Figure B-38: Backup System

**Step 3:** The screen is shown in **Figure B-39** appears when system backup is complete. Press any key to reboot the system.

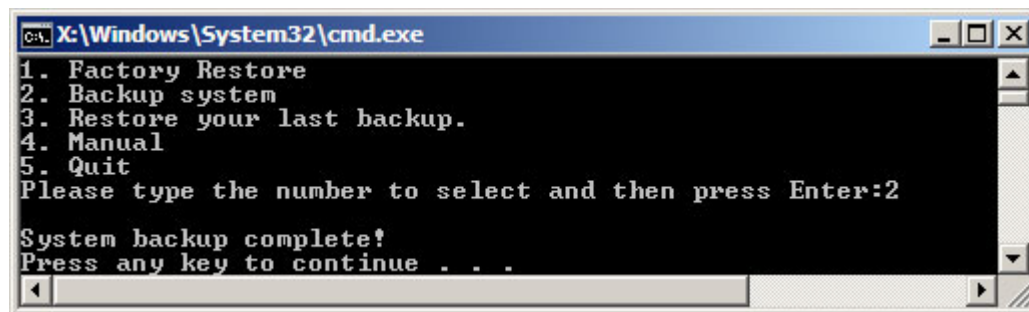

Figure B-39: System Backup Complete Window

### B.5.3 Restore Your Last Backup

To restore the last system backup, please follow the steps below.

**Step 1:** Type <3> and press <Enter> in the main menu.

**Step 2:** The Symantec Ghost window appears and starts to restore the last backup image (iei\_user.GHO).

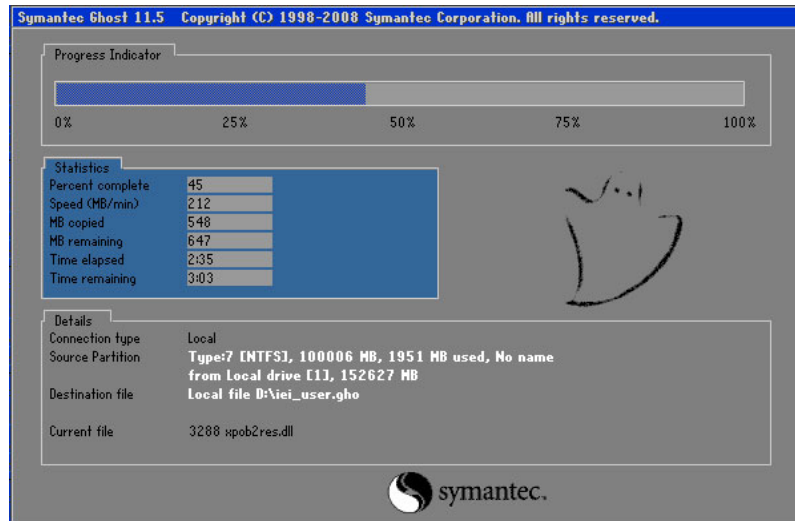

**Figure B-40: Restore Backup**

**Step 3:** The screen shown in **Figure B-41** appears when backup recovery is complete. Press any key to reboot the system.

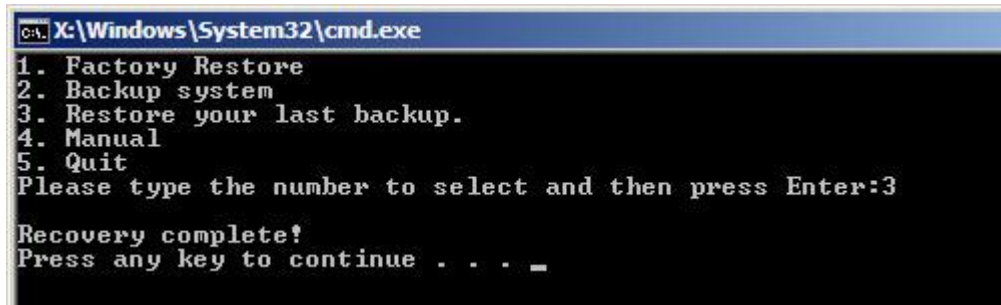

**Figure B-41: Restore System Backup Complete Window**

## WAFER-CV-D25501/N26001 3.5" Motherboard

### B.5.4 Manual

To restore the last system backup, please follow the steps below.

**Step 1:** Type <4> and press <Enter> in the main menu.

**Step 2:** The Symantec Ghost window appears. Use the Ghost program to backup or recover the system manually.

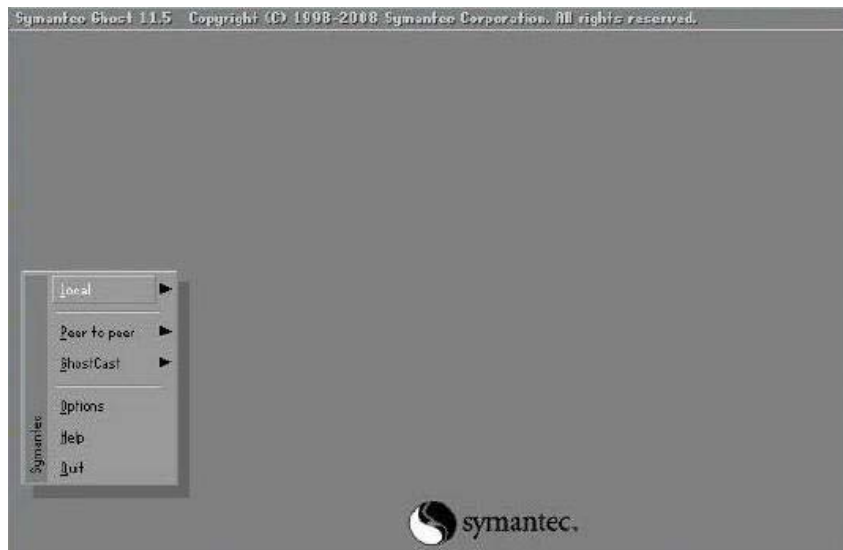
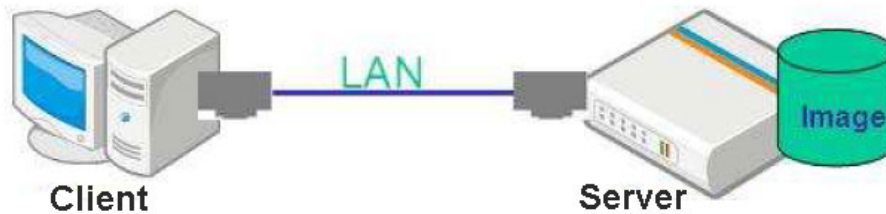

Figure B-42: Symantec Ghost Window

**Step 3:** When backup or recovery is completed, press any key to reboot the system.

## B.6 Restore Systems from a Linux Server through LAN

The One Key Recovery allows a client system to automatically restore to a factory default image saved in a Linux system (the server) through LAN connectivity after encountering a Blue Screen of Death (BSoD) or a hang for around 10 minutes. To be able to use this function, the client system and the Linux system MUST reside in the same domain.



### CAUTION:

The supported client OS includes:

- Windows 2000
- Windows XP
- Windows Vista
- Windows 7
- Windows XP Embedded
- Windows Embedded Standard 7

Prior to restoring client systems from a Linux server, a few setup procedures are required.

**Step 1:** Configure DHCP server settings

**Step 2:** Configure TFTP settings

**Step 3:** Configure One Key Recovery server settings

**Step 4:** Start DHCP, TFTP and HTTP

**Step 5:** Create a shared directory

**Step 6:** Setup a client system for auto recovery

The detailed descriptions are described in the following sections. In this document, two types of Linux OS are used as examples to explain the configuration process – CentOS 5.5 (Kernel 2.6.18) and Debian 5.0.7 (Kernel 2.6.26).

## WAFER-CV-D25501/N26001 3.5" Motherboard

### B.6.1 Configure DHCP Server Settings

**Step 1:** Install the DHCP

`#yum install dhcp` (CentOS, commands marked in red)

`#apt-get install dhcp3-server` (Debian, commands marked in blue)

**Step 2:** Confirm the operating system default settings: dhcpd.conf.

#### CentOS

Use the following command to show the DHCP server sample location:

`#vi /etc/dhcpd.conf`

The DHCP server sample location is shown as below:

```
# DHCP Server Configuration file.
# see /usr/share/doc/dhcp*/dhcpd.conf.sample
```

Use the following command to copy the DHCP server sample to etc/dhcpd.conf:

`#cp /usr/share/doc/dhcp-3.0.5/dhcpd.conf.sample /etc/dhcpd.conf`

`#vi /etc/dhcpd.conf`

```
ddns-update-style interim;
ignore client-updates;

subnet 192.168.0.0 netmask 255.255.255.0 {
# --- default gateway
    option routers                192.168.0.2;
    option subnet-mask            255.255.255.0;

    option nis-domain              "domain.org";
    option domain-name             "domain.org";
    option domain-name-servers    192.168.0.1;
    next-server 192.168.0.6;
    filename "pxelinux.0";
    option time-offset             -18000; # Eastern Standard Time
    option ntp-servers             192.168.1.1;
}
```

#### Debian

`#vi /etc/dhcpd.conf`

Edit “/etc/dhcpd.conf” for your environment. For example, add

`next-server PXE server IP address;`

```
filename "pxelinux.0";
```

```
ddns-update-style interim;
ignore client-updates;

subnet 192.168.0.0 netmask 255.255.255.0 {
# --- default gateway
    option routers                192.168.0.2;
    option subnet-mask            255.255.255.0;

    option nis-domain             "domain.org";
    option domain-name            "domain.org";
    option domain-name-servers    192.168.0.1;
    next-server 192.168.0.6;
    filename "pxelinux.0";
    option time-offset            -18000; # Eastern Standard Time
    option ntp-servers            192.168.1.1;
}
```

## B.6.2 Configure TFTP Settings

**Step 1:** Install the tftp, httpd and syslinux.

```
#yum install tftp-server httpd syslinux (CentOS)
```

```
#apt-get install tftpd-hpa xinetd syslinux (Debian)
```

**Step 2:** Enable the TFTP server by editing the "/etc/xinetd.d/tftp" file and make it use the remap file. The "-vvv" is optional but it could definitely help on getting more information while running the remap file. For example:

### CentOS

```
#vi /etc/xinetd.d/tftp
```

Modify:

```
disable = no
```

```
server_args = -s /tftpboot -m /tftpboot/tftpd.remap -vvv_
```

```
socket_type      = dgram
protocol        = udp
wait            = yes
user            = root
server          = /usr/sbin/in.tftpd
server_args     = -s /tftpboot -m /tftpboot/tftpd.remap -vvv
disable         = no
per_source      = 11
cps             = 100 2
flags           = IPv4
```

## WAFER-CV-D25501/N26001 3.5" Motherboard

### Debian

Replace the TFTP settings from “inetd” to “xinetd” and annotate the “inetd” by adding “#”.

`#vi /etc/inetd.conf`

Modify: `#tftp dgram udp wait root /usr/sbin.....` (as shown below)

```
#:BOOT: TFTP service is provided primarily for booting. Most sites
# run this only on machines acting as "boot servers."
#tftp dgram udp wait root /usr/sbin/in.tftpd /usr/sbin/in.tftpd -s
/var/lib/tftpboot
```

`#vi /etc/xinetd.d/tftp`

```
socket_type      = dgram
protocol        = udp
wait            = yes
user            = root
server          = /usr/sbin/in.tftpd
server_args     = -s /tftpboot -n /tftpboot/tftpd.remap -vvv
disable         = no
per_source      = 11
cps             = 100 2
flags           = IPv4
```

### B.6.3 Configure One Key Recovery Server Settings

**Step 1:** Copy the **Utility/RECOVERYR10.TAR.BZ2** package from the One Key Recovery CD to the system (server side).



**Step 2:** Extract the recovery package to /.

```
#cp RecoveryR10.tar.bz2 /
#cd /
#tar -xvjf RecoveryR10.tar.bz2
```

**Step 3:** Copy “pxelinux.0” from “syslinux” and install to “tftpboot”.

```
#cp /usr/lib/syslinux/pxelinux.0 /tftpboot/
```



## B.6.4 Start the DHCP, TFTP and HTTP

Start the DHCP, TFTP and HTTP. For example:

### CentOS

```
#service xinetd restart
```

```
#service httpd restart
```

```
#service dhcpd restart
```

### Debian

```
#/etc/init.d/xinetd reload
```

```
#/etc/init.d/xinetd restart
```

```
#/etc/init.d/dhcp3-server restart
```

## B.6.5 Create Shared Directory

**Step 1:** Install the samba.

```
#yum install samba
```

**Step 2:** Create a shared directory for the factory default image.

```
#mkdir /share
```

```
#cd /share
```

```
#mkdir /image
```

```
#cp iei.gho /image
```



### **WARNING:**

The file name of the factory default image must be **iei.gho**.

---

**Step 3:** Confirm the operating system default settings: smb.conf.

```
#vi /etc/samba/smb.conf
```

## WAFER-CV-D25501/N26001 3.5" Motherboard

Modify:

[image]

```
comment = One Key Recovery
```

```
path = /share/image
```

```
browseable = yes
```

```
writable = yes
```

```
public = yes
```

```
create mask = 0644
```

```
directory mask = 0755
```

**Step 4:** Edit “/etc/samba/smb.conf” for your environment. For example:

```
# "security = user" is always a good idea. This will require a Unix account
# in this server for every user accessing the server. See
# /usr/share/doc/samba-doc/html/docs/Samba3-HOWTO/ServerType.html
# in the samba-doc package for details.
security = share
```

```
[image]
comment = One Key Recovery
path = /share/image
browseable = yes
writable = yes
public = yes
create mask = 0644
directory mask = 0755
```

**Step 5:** Modify the hostname

```
#vi /etc/hostname
```

Modify: RecoveryServer

```
RecoveryServer
```

### B.6.6 Setup a Client System for Auto Recovery

**Step 1:** Disable the automatically restart function before creating the factory default image. Go to: My Computer → Properties → Advanced. Click the Settings button of Startup and Recovery. Deselect “Automatically restart”. Click OK to save the settings and exit. (See **Figure B-43**)

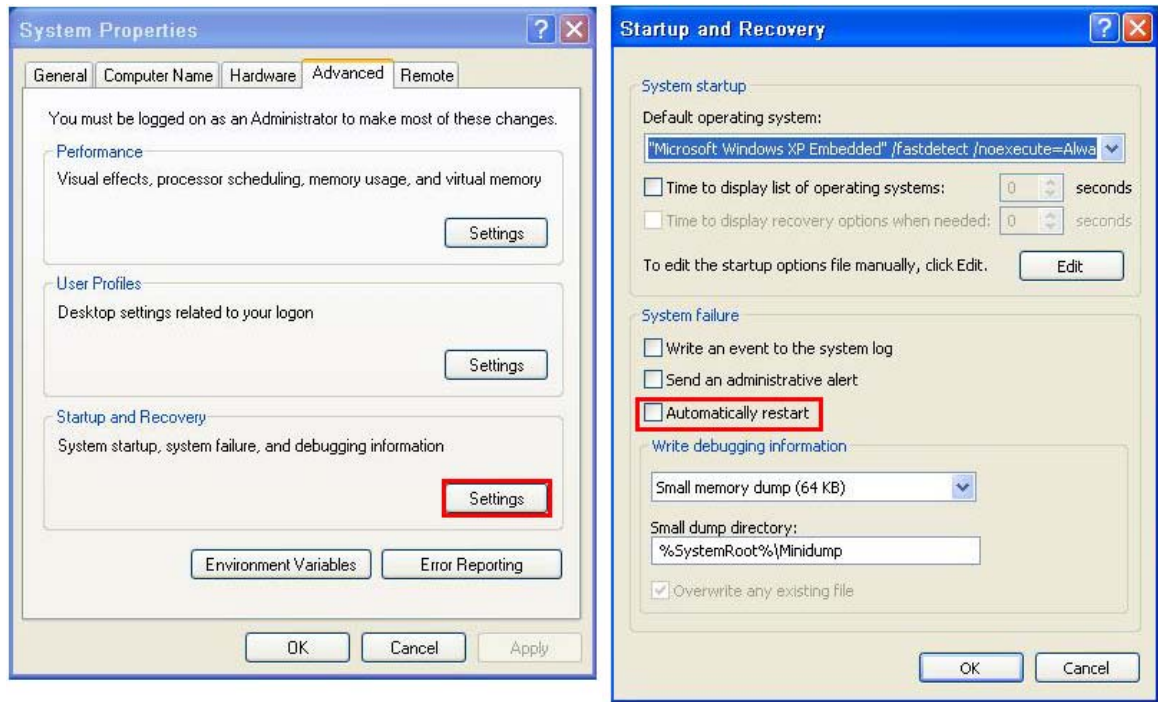

**Figure B-43: Disable Automatically Restart**

**Step 2:** Configure the following BIOS options of the client system.

Advanced → iEi Feature → Auto Recovery Function → **Enabled**

Advanced → iEi Feature → Recover from PXE → **Enabled**

Boot → Launch PXE OpROM → **Enabled**

**Step 3:** Continue to configure the **Boot Option Priorities** BIOS option of the client system:

Boot Option #1 → remain the default setting to boot from the original OS.

Boot Option #2 → select the boot from LAN option.

**Step 4:** Save changes and exit BIOS menu.

Exit → **Save Changes and Exit**

**Step 5:** Install the auto recovery utility into the system by double clicking the

**Utility/AUTORECOVERY-SETUP.exe** in the One Key Recovery CD. This utility

## WAFER-CV-D25501/N26001 3.5" Motherboard

MUST be installed in the system, otherwise, the system will automatically restore from the factory default image every ten (10) minutes.



**Step 6:** Restart the client system from LAN. If the system encounters a Blue Screen of Death (BSoD) or a hang for around 10 minutes, it will automatically restore from the factory default image. The following screens will show when the system starts auto recovering.

```
Realtek PCIe GBE Family Controller Series v2.35 (06/14/10)
CLIENT MAC ADDR: 00 18 7D 13 E6 89  GUID: 00020003-0004-0005-0006-0007000000
DHCP . . /
```

```
My IP address seems to be C0A80009 192.168.0.9
ip=192.168.0.9:192.168.0.8:192.168.0.2:255.255.255.0
TFTP prefix:
Trying to load: pxelinux.cfg/00020003-0004-0005-0006-000700000009
Trying to load: pxelinux.cfg/01-00-18-7d-13-e6-89
Trying to load: pxelinux.cfg/C0A80009
Trying to load: pxelinux.cfg/C0A8000
Trying to load: pxelinux.cfg/C0A800
Trying to load: pxelinux.cfg/C0A80
Trying to load: pxelinux.cfg/C0A8
Trying to load: pxelinux.cfg/C0A
Trying to load: pxelinux.cfg/C0
Trying to load: pxelinux.cfg/C
Trying to load: pxelinux.cfg/default
boot:
```

```
Windows is loading files...
IP: 192.168.0.8, File: \Boot\WinPE.wim
```

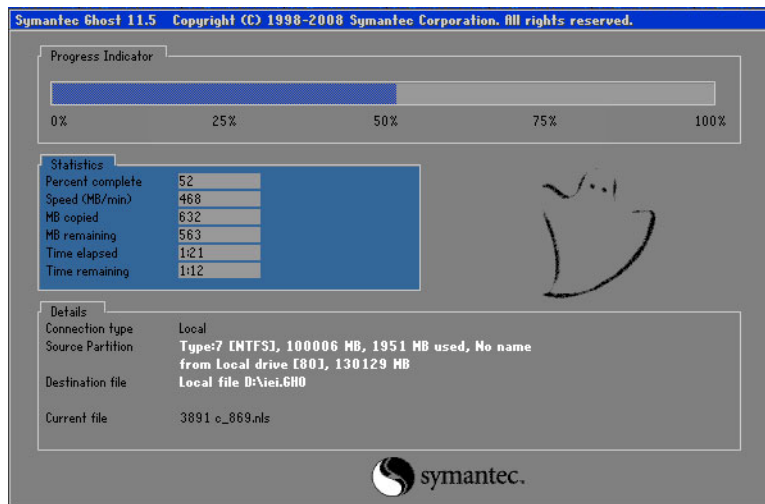
**NOTE:**

A firewall or a SELinux is not in use in the whole setup process described above. If there is a firewall or a SELinux protecting the system, modify the configuration information to accommodate them.

## B.7 Other Information

### B.7.1 Using AHCI Mode or ALi M5283 / VIA VT6421A Controller

When the system uses AHCI mode or some specific SATA controllers such as ALi M5283 or VIA VT6421A, the SATA RAID/AHCI driver must be installed before using one key recovery. Please follow the steps below to install the SATA RAID/AHCI driver.

- Step 1:** Copy the SATA RAID/AHCI driver to a floppy disk and insert the floppy disk into a USB floppy disk drive. The SATA RAID/AHCI driver must be especially designed for the on-board SATA controller.
- Step 2:** Connect the USB floppy disk drive to the system.
- Step 3:** Insert the One Key Recovery CD into the system and boot the system from the CD.
- Step 4:** When launching the recovery tool, press <F6>.

## WAFER-CV-D25501/N26001 3.5" Motherboard

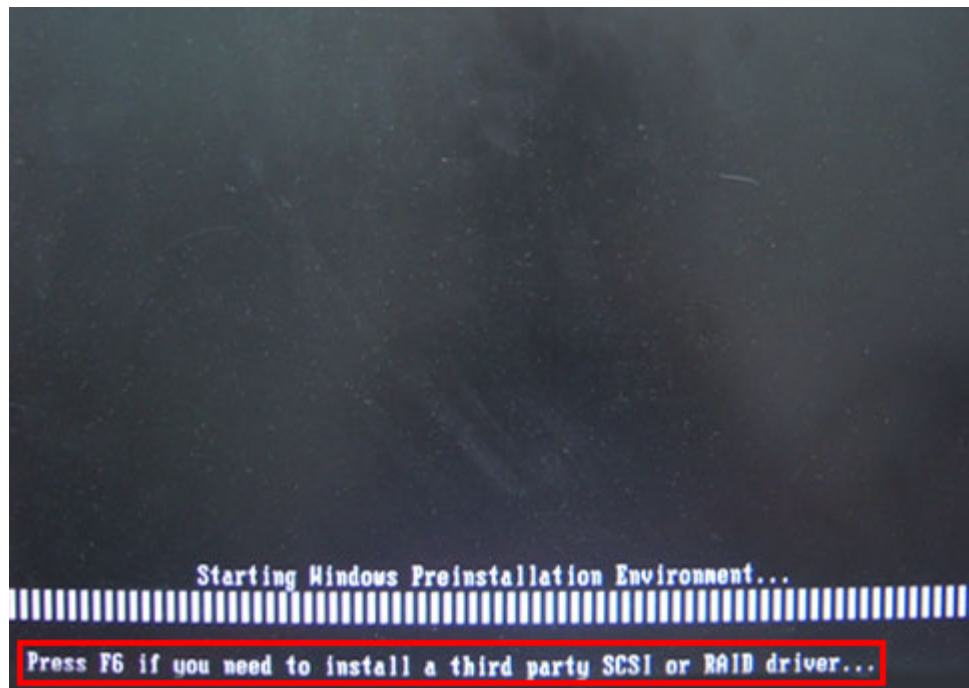

**Step 5:** When the following window appears, press <S> to select "Specify Additional Device".

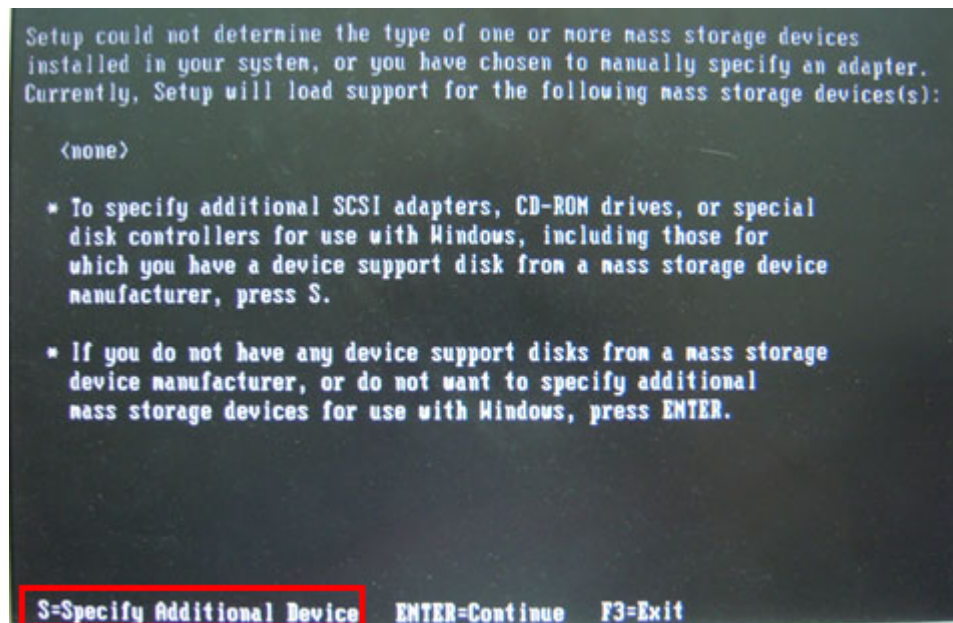

**Step 6:** In the following window, select a SATA controller mode used in the system. Then press <Enter>. The user can now start using the SATA HDD.

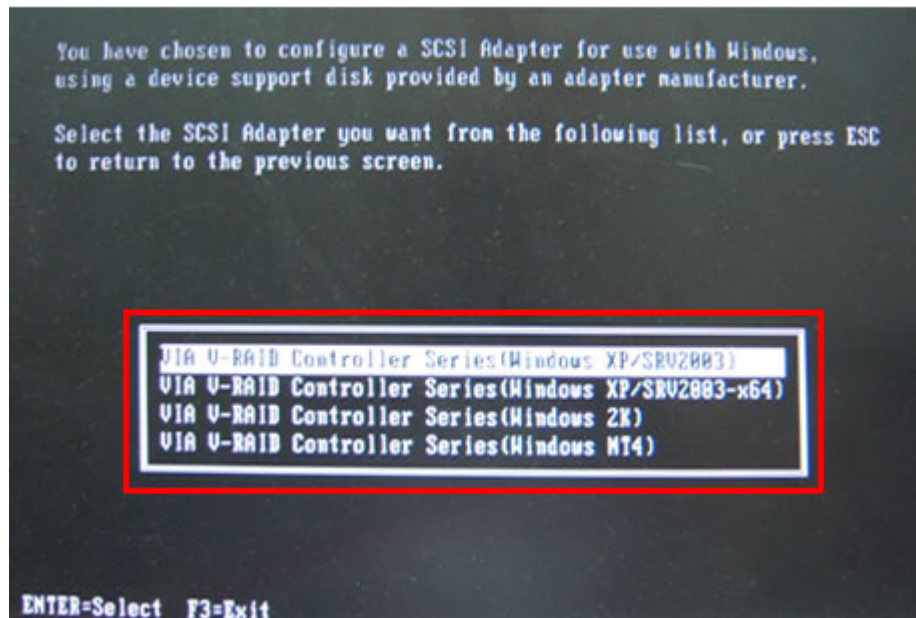

**Step 7:** After pressing <Enter>, the system will get into the recovery tool setup menu. Continue to follow the setup procedure from **Step 4** in **Section B.2.2 Create Partitions** to finish the whole setup process.

### B.7.2 System Memory Requirement

To be able to access the recovery tool by pressing <F3> while booting up the system, please make sure to have enough system memory. The minimum memory requirement is listed below.

- **Using Award BIOS:** 128 MB system memory
- **Using AMI BIOS:** 512 MB system memory.

Appendix

C

# Terminology

---



<b>AC '97</b>	Audio Codec 97 (AC'97) refers to a codec standard developed by Intel® in 1997.
<b>ACPI</b>	Advanced Configuration and Power Interface (ACPI) is an OS-directed configuration, power management, and thermal management interface.
<b>AHCI</b>	Advanced Host Controller Interface (AHCI) is a SATA Host controller register-level interface.
<b>ATA</b>	The Advanced Technology Attachment (ATA) interface connects storage devices including hard disks and CD-ROM drives to a computer.
<b>ARMD</b>	An ATAPI Removable Media Device (ARMD) is any ATAPI device that supports removable media, besides CD and DVD drives.
<b>ASKIR</b>	Amplitude Shift Keyed Infrared (ASKIR) is a form of modulation that represents a digital signal by varying the amplitude ("volume") of the signal. A low amplitude signal represents a binary 0, while a high amplitude signal represents a binary 1.
<b>BIOS</b>	The Basic Input/Output System (BIOS) is firmware that is first run when the computer is turned on and can be configured by the end user
<b>CODEC</b>	The Compressor-Decompressor (CODEC) encodes and decodes digital audio data on the system.
<b>CMOS</b>	Complimentary metal-oxide-conductor is an integrated circuit used in chips like static RAM and microprocessors.
<b>COM</b>	COM refers to serial ports. Serial ports offer serial communication to expansion devices. The serial port on a personal computer is usually a male DB-9 connector.
<b>DAC</b>	The Digital-to-Analog Converter (DAC) converts digital signals to analog signals.
<b>DDR</b>	Double Data Rate refers to a data bus transferring data on both the rising and falling edges of the clock signal.
<b>DMA</b>	Direct Memory Access (DMA) enables some peripheral devices to bypass the system processor and communicate directly with the system memory.

## WAFER-CV-D25501/N26001 3.5" Motherboard

<b>DIMM</b>	Dual Inline Memory Modules are a type of RAM that offer a 64-bit data bus and have separate electrical contacts on each side of the module.
<b>DIO</b>	The digital inputs and digital outputs are general control signals that control the on/off circuit of external devices or TTL devices. Data can be read or written to the selected address to enable the DIO functions.
<b>EHCI</b>	The Enhanced Host Controller Interface (EHCI) specification is a register-level interface description for USB 2.0 Host Controllers.
<b>EIDE</b>	Enhanced IDE (EIDE) is a newer IDE interface standard that has data transfer rates between 4.0 MBps and 16.6 MBps.
<b>EIST</b>	Enhanced Intel® SpeedStep Technology (EIST) allows users to modify the power consumption levels and processor performance through application software. The application software changes the bus-to-core frequency ratio and the processor core voltage.
<b>FSB</b>	The Front Side Bus (FSB) is the bi-directional communication channel between the processor and the Northbridge chipset.
<b>GbE</b>	Gigabit Ethernet (GbE) is an Ethernet version that transfers data at 1.0 Gbps and complies with the IEEE 802.3-2005 standard.
<b>GPIO</b>	General purpose input
<b>HDD</b>	Hard disk drive (HDD) is a type of magnetic, non-volatile computer storage device that stores digitally encoded data.
<b>ICH</b>	The Input/Output Control Hub (ICH) is an Intel® Southbridge chipset.
<b>IrDA</b>	Infrared Data Association (IrDA) specify infrared data transmission protocols used to enable electronic devices to wirelessly communicate with each other.
<b>L1 Cache</b>	The Level 1 Cache (L1 Cache) is a small memory cache built into the system processor.
<b>L2 Cache</b>	The Level 2 Cache (L2 Cache) is an external processor memory cache.
<b>LCD</b>	Liquid crystal display (LCD) is a flat, low-power display device that consists of two polarizing plates with a liquid crystal panel in between.

<b>LVDS</b>	Low-voltage differential signaling (LVDS) is a dual-wire, high-speed differential electrical signaling system commonly used to connect LCD displays to a computer.
<b>POST</b>	The Power-on Self Test (POST) is the pre-boot actions the system performs when the system is turned-on.
<b>RAM</b>	Random Access Memory (RAM) is volatile memory that loses data when power is lost. RAM has very fast data transfer rates compared to other storage like hard drives.
<b>SATA</b>	Serial ATA (SATA) is a serial communications bus designed for data transfers between storage devices and the computer chipsets. The SATA bus has transfer speeds up to 1.5 Gbps and the SATA II bus has data transfer speeds of up to 3.0 Gbps.
<b>S.M.A.R.T</b>	Self Monitoring Analysis and Reporting Technology (S.M.A.R.T) refers to automatic status checking technology implemented on hard disk drives.
<b>UART</b>	Universal Asynchronous Receiver-transmitter (UART) is responsible for asynchronous communications on the system and manages the system's serial communication (COM) ports.
<b>UHCI</b>	The Universal Host Controller Interface (UHCI) specification is a register-level interface description for USB 1.1 Host Controllers.
<b>USB</b>	The Universal Serial Bus (USB) is an external bus standard for interfacing devices. USB 1.1 supports 12Mbps data transfer rates and USB 2.0 supports 480Mbps data transfer rates.
<b>VGA</b>	The Video Graphics Array (VGA) is a graphics display system developed by IBM.

Appendix

D

# Digital I/O Interface

---

## D.1 Introduction

The DIO connector on the WAFER-CV-D25501/N26001 is interfaced to GPIO ports on the Super I/O chipset. The DIO has both 4-bit digital inputs and 4-bit digital outputs. The digital inputs and digital outputs are generally control signals that control the on/off circuit of external devices or TTL devices. Data can be read or written to the selected address to enable the DIO functions.



### NOTE:

For further information, please refer to the datasheet for the Super I/O chipset.

## D.2 DIO Connector Pinouts

The following table describes how the DIO connector pins are connected to the Super I/O GPIO port 1.

Pin	Description	Super I/O Pin	Super I/O Pin Description
1	Ground	N/A	N/A
2	VCC	N/A	N/A
3	Output 3	GP27	General purpose I/O port 2 bit 7.
4	Output 2	GP26	General purpose I/O port 2 bit 6.
5	Output 1	GP25	General purpose I/O port 2 bit 5.
6	Output 0	GP24	General purpose I/O port 2 bit 4.
7	Input 3	GP23	General purpose I/O port 2 bit 3.
8	Input 2	GP22	General purpose I/O port 2 bit 2
9	Input 1	GP21	General purpose I/O port 2 bit 1
10	Input 0	GP20	General purpose I/O port 2 bit 0

**Table D-1: Digital I/O Connector Pinouts**

## D.3 Assembly Language Samples

### D.3.1 Enable the DIO Input Function

The BIOS interrupt call INT 15H controls the digital I/O. An assembly program to enable digital I/O input functions is listed below.

<b>MOV</b>	<b>AX, 6F08H</b>	Sets the digital port as input
<b>INT</b>	<b>15H</b>	Initiates the INT 15H BIOS call

### D.3.2 Enable the DIO Output Function

The BIOS interrupt call INT 15H controls the digital I/O. An assembly program to enable digital I/O output functions is listed below.

<b>MOV</b>	<b>AX, 6F09H</b>	Sets the digital port as output
<b>MOV</b>	<b>BL, 09H</b>	
<b>INT</b>	<b>15H</b>	Initiates the INT 15H BIOS call



Appendix

E

# Watchdog Timer

---



**NOTE:**

The following discussion applies to DOS environment. Contact IEI support or visit the IEI website for specific drivers for other operating systems.

The Watchdog Timer is provided to ensure that standalone systems can always recover from catastrophic conditions that cause the CPU to crash. This condition may have occurred by external EMIs or a software bug. When the CPU stops working correctly, Watchdog Timer either performs a hardware reset (cold boot) or a Non-Maskable Interrupt (NMI) to bring the system back to a known state.

A BIOS function call (INT 15H) is used to control the Watchdog Timer.

INT 15H:

AH – 6FH Sub-function:	
AL – 2:	Sets the Watchdog Timer's period.
BL:	Time-out value (Its unit-second is dependent on the item "Watchdog Timer unit select" in CMOS setup).

**Table E-1: AH-6FH Sub-function**

Call sub-function 2 to set the time-out period of Watchdog Timer first. If the time-out value is not zero, the Watchdog Timer starts counting down. When the timer value reaches zero, the system resets. To ensure that this reset condition does not occur, calling sub-function 2 must periodically refresh the Watchdog Timer. However, the watchdog timer is disabled if the time-out value is set to zero.

A tolerance of at least 10% must be maintained to avoid unknown routines within the operating system (DOS), such as disk I/O that can be very time-consuming.





**NOTE:**

When exiting a program it is necessary to disable the Watchdog Timer, otherwise the system resets.

**EXAMPLE PROGRAM:**

**; INITIAL TIMER PERIOD COUNTER**

;

**W\_LOOP:**

;

```

MOV      AX, 6F02H      ;setting the time-out value
MOV      BL, 30         ;time-out value is 48 seconds
INT      15H

```

;

**; ADD THE APPLICATION PROGRAM HERE**

;

```

CMP      EXIT_AP, 1     ;is the application over?
JNE      W_LOOP        ;No, restart the application

```

```

MOV      AX, 6F02H      ;disable Watchdog Timer
MOV      BL, 0          ;
INT      15H

```

;

**; EXIT ;**

Appendix

F

# Hazardous Materials Disclosure

---

## **F.1 Hazardous Materials Disclosure Table for IPB Products Certified as RoHS Compliant Under 2002/95/EC Without Mercury**

The details provided in this appendix are to ensure that the product is compliant with the Peoples Republic of China (China) RoHS standards. The table below acknowledges the presences of small quantities of certain materials in the product, and is applicable to China RoHS only.

A label will be placed on each product to indicate the estimated “Environmentally Friendly Use Period” (EFUP). This is an estimate of the number of years that these substances would “not leak out or undergo abrupt change.” This product may contain replaceable sub-assemblies/components which have a shorter EFUP such as batteries and lamps. These components will be separately marked.

Please refer to the table on the next page.

## WAFER-CV-D25501/N26001 3.5" Motherboard

Part Name	Toxic or Hazardous Substances and Elements					
	Lead (Pb)	Mercury (Hg)	Cadmium (Cd)	Hexavalent Chromium (CR(VI))	Polybrominated Biphenyls (PBB)	Polybrominated Diphenyl Ethers (PBDE)
<b>Housing</b>	X	O	O	O	O	X
<b>Display</b>	X	O	O	O	O	X
<b>Printed Circuit Board</b>	X	O	O	O	O	X
<b>Metal Fasteners</b>	X	O	O	O	O	O
<b>Cable Assembly</b>	X	O	O	O	O	X
<b>Fan Assembly</b>	X	O	O	O	O	X
<b>Power Supply Assemblies</b>	X	O	O	O	O	X
<b>Battery</b>	O	O	O	O	O	O

O: This toxic or hazardous substance is contained in all of the homogeneous materials for the part is below the limit requirement in SJ/T11363-2006

X: This toxic or hazardous substance is contained in at least one of the homogeneous materials for this part is above the limit requirement in SJ/T11363-2006

此附件旨在确保本产品符合中国 RoHS 标准。以下表格标示此产品中某有毒物质的含量符合中国 RoHS 标准规定的限量要求。

本产品上会附有“环境友好使用期限”的标签，此期限是估算这些物质“不会有泄漏或突变”的年限。本产品可能包含有较短的环境友好使用期限的可替换元件，像是电池或灯管，这些元件将会单独标示出来。

部件名称	有毒有害物质或元素					
	铅 (Pb)	汞 (Hg)	镉 (Cd)	六价铬 (CR(VI))	多溴联苯 (PBB)	多溴二苯 醚 (PBDE)
壳体	X	O	O	O	O	X
显示	X	O	O	O	O	X
印刷电路板	X	O	O	O	O	X
金属螺帽	X	O	O	O	O	O
电缆组装	X	O	O	O	O	X
风扇组装	X	O	O	O	O	X
电力供应组装	X	O	O	O	O	X
电池	O	O	O	O	O	O

O: 表示该有毒有害物质在该部件所有物质材料中的含量均在 SJ/T11363-2006 标准规定的限量要求以下。  
X: 表示该有毒有害物质至少在该部件的某一均质材料中的含量超出 SJ/T11363-2006 标准规定的限量要求。