

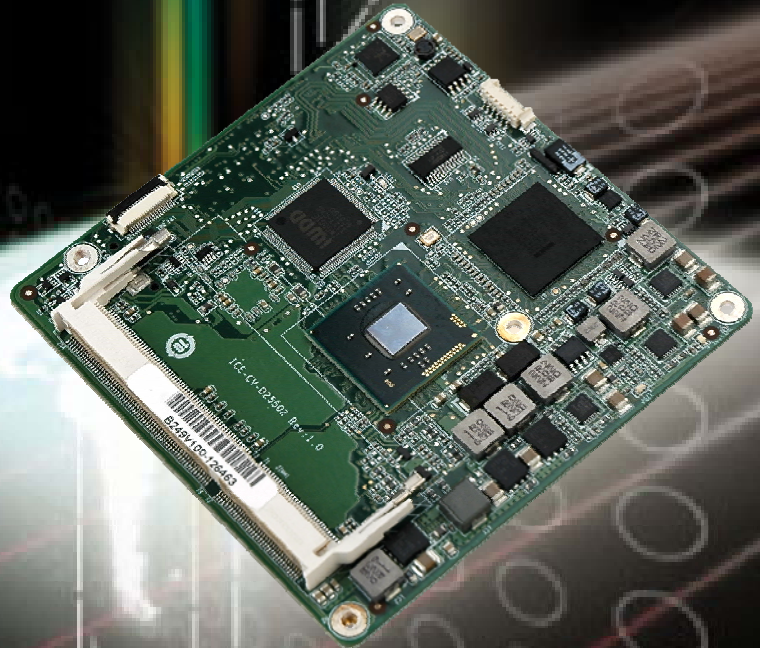

IEI Technology Corp.



**MODEL:**  
**ICE-CV-D25502/N26002**

**COM Express R2.0 Module (Type 2),  
Intel® Atom™ D2550/N2600 Processor,  
DDR3 and RoHS Compliant**

## **User Manual**

Rev. 1.00 – 3 October, 2012



# Revision

---

Date	Version	Changes
3 October, 2012	1.00	Initial release

# Copyright

---

## **COPYRIGHT NOTICE**

The information in this document is subject to change without prior notice in order to improve reliability, design and function and does not represent a commitment on the part of the manufacturer.

In no event will the manufacturer be liable for direct, indirect, special, incidental, or consequential damages arising out of the use or inability to use the product or documentation, even if advised of the possibility of such damages.

This document contains proprietary information protected by copyright. All rights are reserved. No part of this manual may be reproduced by any mechanical, electronic, or other means in any form without prior written permission of the manufacturer.

## **TRADEMARKS**

All registered trademarks and product names mentioned herein are used for identification purposes only and may be trademarks and/or registered trademarks of their respective owners.

# Table of Contents

<b>1 INTRODUCTION.....</b>	<b>1</b>
1.1 INTRODUCTION.....	2
1.2 MODEL VARIATIONS .....	2
1.3 FEATURES.....	3
1.4 CONNECTORS .....	3
1.5 DIMENSIONS.....	4
1.6 DATA FLOW .....	5
1.7 TECHNICAL SPECIFICATIONS .....	6
<b>2 PACKING LIST.....</b>	<b>8</b>
2.1 ANTI-STATIC PRECAUTIONS .....	9
2.2 UNPACKING PRECAUTIONS.....	9
2.3 PACKING LIST.....	10
2.4 OPTIONAL ITEMS .....	11
<b>3 CONNECTORS .....</b>	<b>12</b>
3.1 PERIPHERAL INTERFACE CONNECTORS.....	13
3.1.1 ICE-CV-D25502/N26002 Layout.....	13
3.1.2 Peripheral Interface Connectors .....	14
3.2 INTERNAL PERIPHERAL CONNECTORS .....	14
3.2.1 COM Express Connector AB .....	14
3.2.2 COM Express Connector CD.....	18
3.2.3 SO-DIMM Connector.....	23
3.2.4 SPI Connector.....	23
<b>4 INSTALLATION .....</b>	<b>25</b>
4.1 ANTI-STATIC PRECAUTIONS .....	26
4.2 INSTALLATION CONSIDERATIONS.....	26
4.3 SO-DIMM INSTALLATION .....	28
4.4 MOUNTING THE ICE-CV-D25502/N26002 TO AN OPTIONAL BASEBOARD .....	29
<b>5 BIOS.....</b>	<b>32</b>

## ICE-CV-D25502/N26002 COM Express Module

5.1 INTRODUCTION.....	33
5.1.1 Starting Setup.....	33
5.1.2 Using Setup.....	33
5.1.3 Getting Help.....	34
5.1.4 Unable to Reboot after Configuration Changes.....	34
5.1.5 BIOS Menu Bar.....	34
5.2 MAIN.....	35
5.3 ADVANCED.....	36
5.3.1 ACPI Settings.....	36
5.3.2 RTC Wake Settings.....	37
5.3.3 Trusted Computing.....	39
5.3.4 CPU Configuration.....	40
5.3.5 IDE Configuration.....	41
5.3.6 USB Configuration.....	42
5.3.7 iWDD H/W Monitor.....	43
5.3.8 Secondary Super IO Configuration.....	44
5.3.8.1 COM n Configuration.....	44
5.3.9 Super IO Configuration.....	48
5.3.9.1 Floppy Disk Controller Configuration.....	49
5.3.9.2 COM n Configuration.....	50
5.3.9.3 Parallel Port Configuration.....	53
5.3.10 WinBond W83627EHG Hardware Monitor.....	54
5.3.11 Serial Port Console Redirection.....	56
5.3.12 iEi Feature.....	58
5.4 CHIPSET.....	59
5.4.1 Host Bridge Configuration.....	59
5.4.1.1 Intel IGD Configuration.....	60
5.4.2 South Bridge Configuration.....	62
5.5 BOOT.....	63
5.6 SECURITY.....	65
5.7 SAVE & EXIT.....	65
<b>6 SOFTWARE DRIVERS.....</b>	<b>67</b>
6.1 AVAILABLE SOFTWARE DRIVERS.....	68
6.2 STARTING THE DRIVER PROGRAM.....	68

6.3 CHIPSET DRIVER INSTALLATION .....	70
6.4 VGA DRIVER INSTALLATION .....	74
6.5 LAN DRIVER INSTALLATION .....	78
6.6 AUDIO DRIVER INSTALLATION .....	80
<b>A BIOS OPTIONS .....</b>	<b>83</b>
<b>B ONE KEY RECOVERY .....</b>	<b>86</b>
B.1 ONE KEY RECOVERY INTRODUCTION .....	87
<i>B.1.1 System Requirement</i> .....	88
<i>B.1.2 Supported Operating System</i> .....	89
B.2 SETUP PROCEDURE FOR WINDOWS .....	90
<i>B.2.1 Hardware and BIOS Setup</i> .....	91
<i>B.2.2 Create Partitions</i> .....	91
<i>B.2.3 Install Operating System, Drivers and Applications</i> .....	95
<i>B.2.4 Build-up Recovery Partition</i> .....	96
<i>B.2.5 Create Factory Default Image</i> .....	98
B.3 AUTO RECOVERY SETUP PROCEDURE .....	103
B.4 SETUP PROCEDURE FOR LINUX .....	108
B.5 RECOVERY TOOL FUNCTIONS .....	111
<i>B.5.1 Factory Restore</i> .....	113
<i>B.5.2 Backup System</i> .....	114
<i>B.5.3 Restore Your Last Backup</i> .....	115
<i>B.5.4 Manual</i> .....	116
B.6 RESTORE SYSTEMS FROM A LINUX SERVER THROUGH LAN .....	117
<i>B.6.1 Configure DHCP Server Settings</i> .....	118
<i>B.6.2 Configure TFTP Settings</i> .....	119
<i>B.6.3 Configure One Key Recovery Server Settings</i> .....	120
<i>B.6.4 Start the DHCP, TFTP and HTTP</i> .....	121
<i>B.6.5 Create Shared Directory</i> .....	121
<i>B.6.6 Setup a Client System for Auto Recovery</i> .....	122
B.7 OTHER INFORMATION .....	125
<i>B.7.1 Using AHCI Mode or ALi M5283 / VIA VT6421A Controller</i> .....	125
<i>B.7.2 System Memory Requirement</i> .....	127
<b>C TERMINOLOGY .....</b>	<b>128</b>

## ICE-CV-D25502/N26002 COM Express Module

<b>D WATCHDOG TIMER .....</b>	<b>132</b>
<b>E HAZARDOUS MATERIALS DISCLOSURE .....</b>	<b>135</b>
E.1 HAZARDOUS MATERIALS DISCLOSURE TABLE FOR IPB PRODUCTS CERTIFIED AS ROHS COMPLIANT UNDER 2002/95/EC WITHOUT MERCURY .....	136

# List of Figures

Figure 1-1: ICE-CV-D25502/N26002.....	2
Figure 1-2: Connectors .....	3
Figure 1-3: ICE-CV-D25502/N26002 Dimensions (mm).....	4
Figure 1-4: Data Flow Diagram.....	5
Figure 3-1: Connectors .....	13
Figure 3-2: COM Express Connector AB Location .....	14
Figure 3-3: COM Express Connector CD Location .....	19
Figure 3-4: SO-DIMM Connector Location .....	23
Figure 3-5: SPI Flash Connector Location.....	24
Figure 4-1: SO-DIMM Installation .....	28
Figure 4-2: Connect the COM Express Connectors.....	30
Figure 4-3: Attach the Heat Sink to the Heatspreader Plate .....	30
Figure 4-4: Secure the Heatspreader Plate with the Heat Sink to the Baseboard .....	31
Figure 6-1: Start Up Screen .....	69
Figure 6-2: Drivers .....	69
Figure 6-3: Chipset Driver Screen.....	70
Figure 6-4: Chipset Driver Welcome Screen.....	71
Figure 6-5: Chipset Driver License Agreement .....	72
Figure 6-6: Chipset Driver Read Me File .....	72
Figure 6-7: Chipset Driver Setup Operations .....	73
Figure 6-8: Chipset Driver Installation Finish Screen.....	74
Figure 6-9: VGA Driver Welcome Screen .....	75
Figure 6-10: VGA Driver License Agreement.....	76
Figure 6-11: VGA Driver Read Me File.....	76
Figure 6-12: VGA Driver Setup Operations .....	77
Figure 6-13: VGA Driver Installation Finish Screen .....	77
Figure 6-14: LAN Driver Welcome Screen .....	78
Figure 6-15: LAN Driver Installation .....	79
Figure 6-16: LAN Driver Installation Complete.....	79
Figure 6-17: Audio Driver Installation File Extraction.....	80



## ICE-CV-D25502/N26002 COM Express Module

Figure 6-18: Audio Driver Welcome Screen.....	81
Figure 6-19: Audio Driver Installation.....	81
Figure 6-20: Audio Driver Installation Complete .....	82
Figure B-1: IEI One Key Recovery Tool Menu .....	87
Figure B-2: Launching the Recovery Tool .....	92
Figure B-3: Recovery Tool Setup Menu .....	92
Figure B-4: Command Prompt .....	93
Figure B-5: Partition Creation Commands.....	94
Figure B-6: Launching the Recovery Tool .....	96
Figure B-7: Manual Recovery Environment for Windows .....	96
Figure B-8: Building the Recovery Partition.....	97
Figure B-9: Press Any Key to Continue .....	97
Figure B-10: Press F3 to Boot into Recovery Mode.....	98
Figure B-11: Recovery Tool Menu .....	98
Figure B-12: About Symantec Ghost Window.....	99
Figure B-13: Symantec Ghost Path .....	99
Figure B-14: Select a Local Source Drive .....	100
Figure B-15: Select a Source Partition from Basic Drive .....	100
Figure B-16: File Name to Copy Image to .....	101
Figure B-17: Compress Image.....	101
Figure B-18: Image Creation Confirmation .....	102
Figure B-19: Image Creation Complete .....	102
Figure B-20: Image Creation Complete .....	102
Figure B-21: Press Any Key to Continue .....	103
Figure B-22: Auto Recovery Utility .....	104
Figure B-23: Disable Automatically Restart.....	104
Figure B-24: Launching the Recovery Tool .....	105
Figure B-25: Auto Recovery Environment for Windows .....	105
Figure B-26: Building the Auto Recovery Partition.....	106
Figure B-27: Factory Default Image Confirmation .....	106
Figure B-28: Image Creation Complete .....	107
Figure B-29: Press any key to continue .....	107
Figure B-30: IEI Feature .....	108
Figure B-31: Partitions for Linux.....	109
Figure B-32: System Configuration for Linux.....	110



Figure B-33: Access menu.lst in Linux (Text Mode)..... 110

Figure B-34: Recovery Tool Menu ..... 111

Figure B-35: Recovery Tool Main Menu ..... 112

Figure B-36: Restore Factory Default..... 113

Figure B-37: Recovery Complete Window ..... 113

Figure B-38: Backup System..... 114

Figure B-39: System Backup Complete Window ..... 114

Figure B-40: Restore Backup ..... 115

Figure B-41: Restore System Backup Complete Window ..... 115

Figure B-42: Symantec Ghost Window ..... 116

Figure B-43: Disable Automatically Restart..... 123

# List of Tables

---

Table 1-1: ICE-CV-D25502/N26002 Model Variations .....	2
Table 1-2: ICE-CV-D25502/N26002 Specifications.....	7
Table 2-1: Packing List.....	11
Table 2-2: Optional Items .....	11
Table 3-1: Peripheral Interface Connectors .....	14
Table 3-2: COM Express Connector AB Pin Definitions.....	18
Table 3-3: COM Express Connector CD Pin Definitions.....	22
Table 3-4: SPI Flash Connector Pinouts .....	24
Table 5-1: BIOS Navigation Keys .....	34

# BIOS Menus

---

BIOS Menu 1: Main .....	35
BIOS Menu 2: Advanced .....	36
BIOS Menu 3: ACPI Settings .....	37
BIOS Menu 4: RTC Wake Settings .....	38
BIOS Menu 5: Trusted Computing .....	39
BIOS Menu 6: CPU Configuration .....	40
BIOS Menu 7: IDE Configuration .....	41
BIOS Menu 8: USB Configuration .....	42
BIOS Menu 9: iWDD H/W Monitor .....	43
BIOS Menu 10: Secondary Super IO Configuration .....	44
BIOS Menu 11: COM n Configuration Menu .....	44
BIOS Menu 12: Super IO Configuration.....	48
BIOS Menu 13: Floppy Disk Controller Configuration Menu .....	49
BIOS Menu 14: COM n Configuration Menu .....	50
BIOS Menu 15: Parallel Port Configuration Menu .....	53
BIOS Menu 16: WinBond W83627EHG Hardware Monitor .....	55
BIOS Menu 17: Serial Port Console Redirection .....	56
BIOS Menu 18: iEi Feature .....	58
BIOS Menu 19: Chipset .....	59
BIOS Menu 20: Host Bridge Configuration .....	60
BIOS Menu 21: Intel IGD Configuration.....	60
BIOS Menu 22: Southbridge Configuration .....	62
BIOS Menu 23: Boot .....	63
BIOS Menu 24: Security .....	65
BIOS Menu 25: Save & Exit.....	66

Chapter

1

# Introduction

---

## 1.1 Introduction

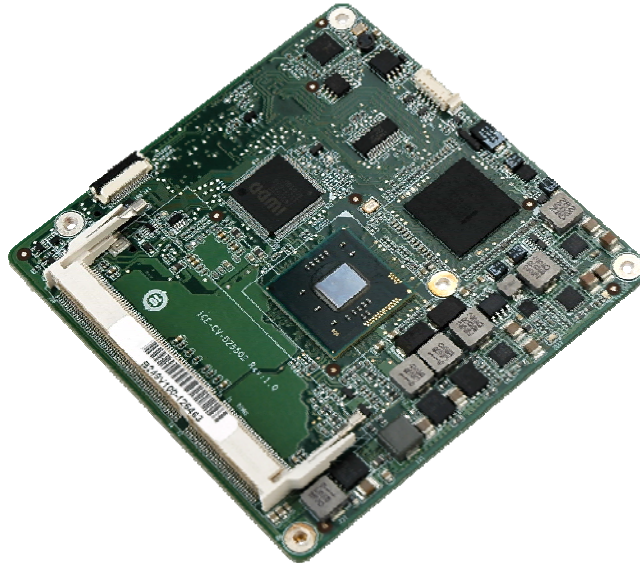

**Figure 1-1: ICE-CV-D25502/N26002**

The ICE-CV-D25502/N26002 COM Express module provides the main processing chips and is connected to a compatible COM Express baseboard. The ICE-CV-D25502/N26002 is equipped with an Intel® Atom™ D2550/N2600 CPU and Intel® NM10 PCH. The COM Express standard allows the COM Express baseboard to be designed, while leaving the choice of processor till the later stages of design. The ICE-CV-D25502/N26002 provides a low power option with the full range of modern I/O options. The ICE-CV-D25502/N26002 embedded module is designed for flexible integration by system developers into customized platform devices.

## 1.2 Model Variations

The model variations of the ICE-CV-D25502/N26002 are listed below.

Model No.	CPU
ICE-CV-D25502-R10	1.86 GHz Intel® Atom™ D2550
ICE-CV-N26002-R10	1.6 GHz Intel® Atom™ N2600

**Table 1-1: ICE-CV-D25502/N26002 Model Variations**

## ICE-CV-D25502/N26002 COM Express Module

### 1.3 Features

Some of the ICE-CV-D25502/N26002 COM Express module features are listed below:

- Complies with COM Express form factor
- Embedded Intel® Atom™ D2550/N2600 CPU and Intel® NM10 PCH
- Supports DDR3/DDR3L (1.35V) SO-DIMM
- Supports 18-/24-bit single-channel LVDS and analog CRT (VGA)
- Supports SATA 3Gb/s and GbE
- Supports eight USB 2.0 devices
- RoHS compliant

### 1.4 Connectors

The connectors on the ICE-CV-D25502/N26002 are shown in the figure below.

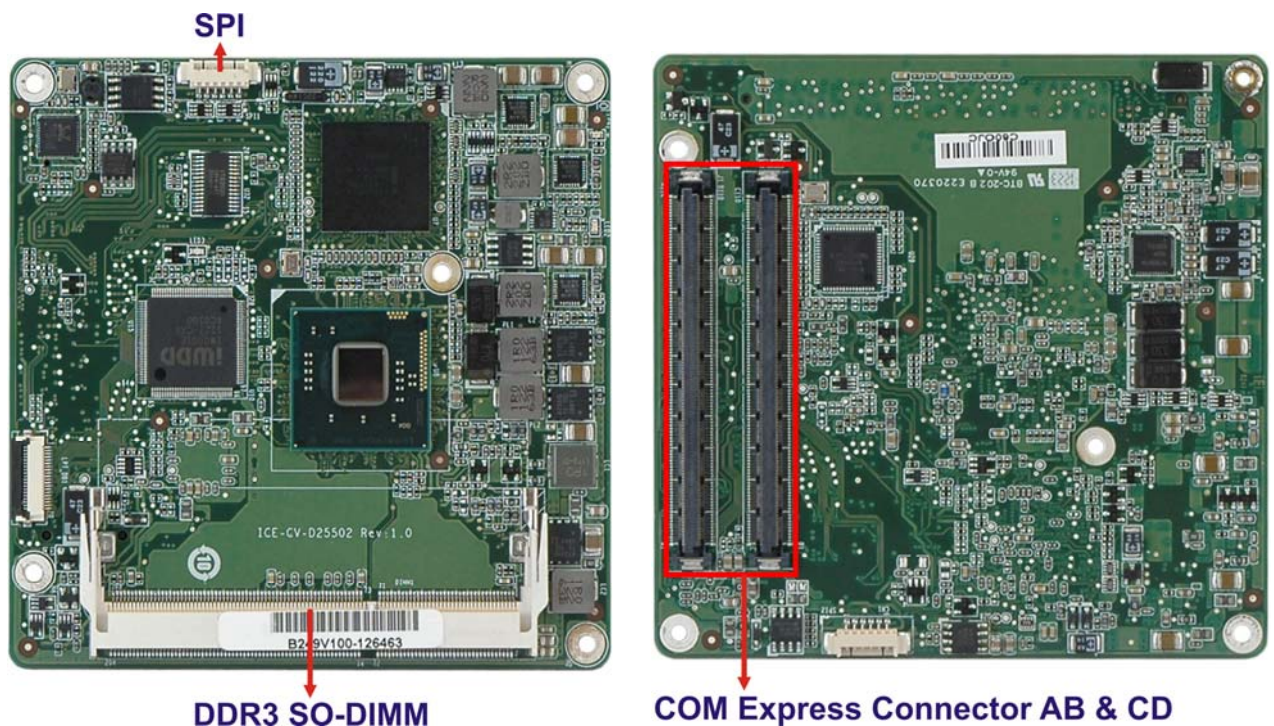
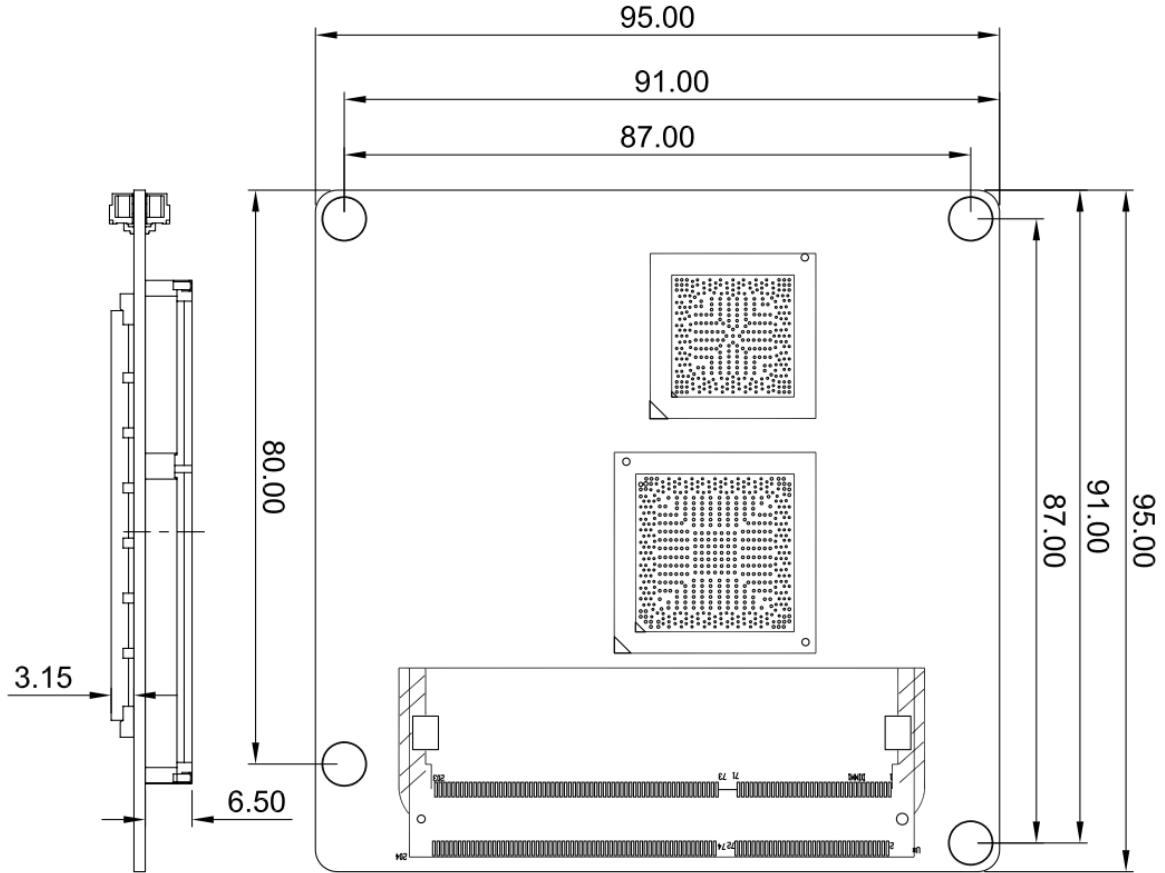

Figure 1-2: Connectors

### 1.5 Dimensions

The main dimensions of the ICE-CV-D25502/N26002 are shown in the diagram below.



**Figure 1-3: ICE-CV-D25502/N26002 Dimensions (mm)**



## ICE-CV-D25502/N26002 COM Express Module

### 1.6 Data Flow

Figure 1-4 shows the data flow between the system chipset, the CPU and other components installed on the motherboard.

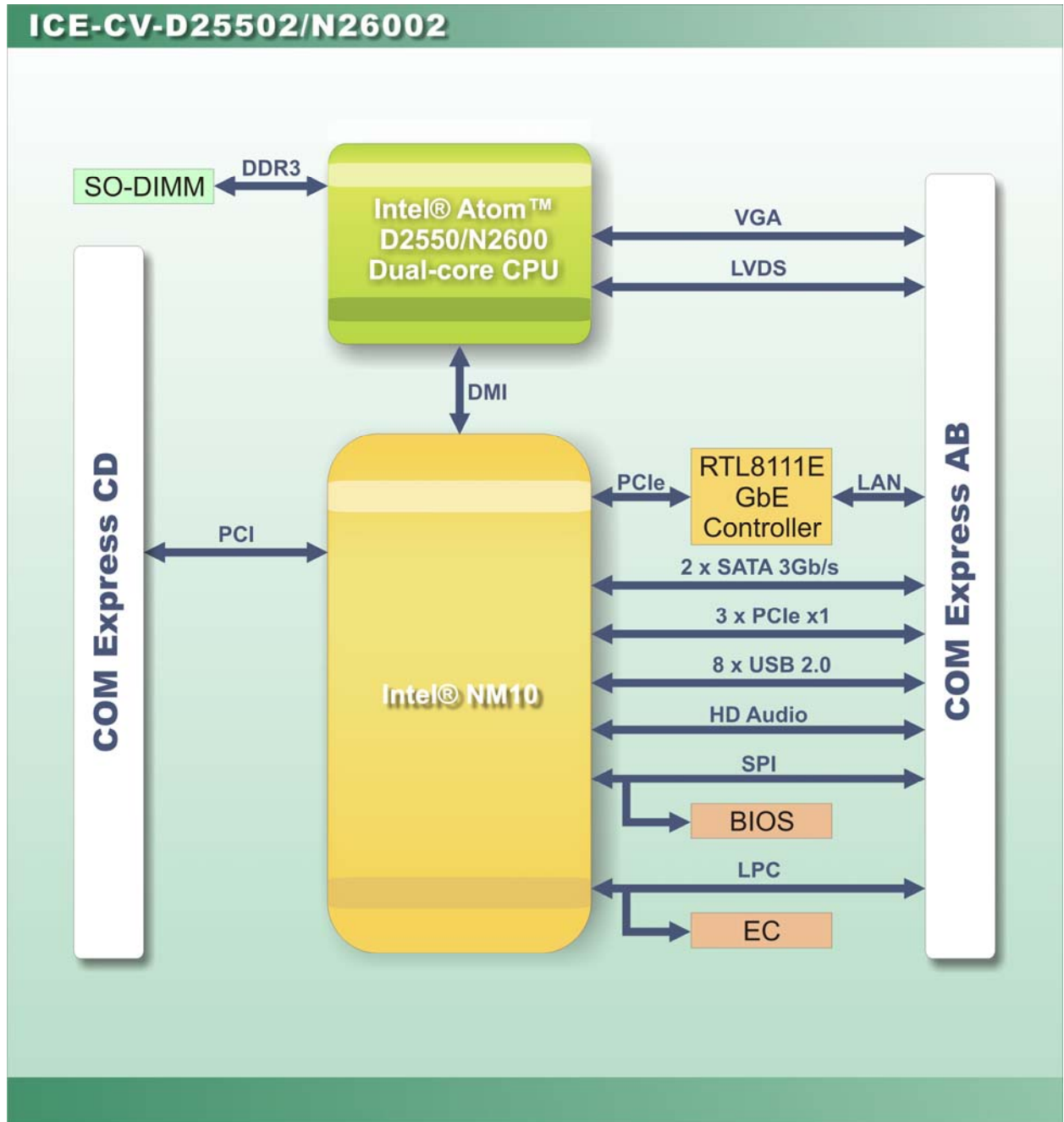

Figure 1-4: Data Flow Diagram

## 1.7 Technical Specifications

The ICE-CV-D25502/N26002 technical specifications are listed below.

Specifications/Model	ICE-CV-D25502/N26002
<b>Form Factor</b>	PICMG COM Express R2.0 Type 2 for compact size (95 mm x 95 mm) 10 layers
<b>CPU</b>	1.86 GHz Intel® Atom™ D2550 dual-core CPU (2 x 512KB L2 cache) 1.6 GHz Intel® Atom™ N2600 dual-core CPU (2 x 512KB L2 cache)
<b>PCH</b>	Intel® NM10
<b>Memory</b>	D2550: One 1066 MHz DDR3/DDR3L (1.35V) SO-DIMM support (up to 4 GB) N2600: One 800 MHz DDR3/DDR3L (1.35V) SO-DIMM support (up to 2 GB)
<b>Graphics Engine</b>	D2550: Intel® GMA 3650 with 640 MHz graphics core speed N2600: Intel® GMA 3600 with 400 MHz graphics core speed Supports DirectX 9 and Blu-ray 2.0 MPEG2, H.264, VC-1 and 1080p decoding
<b>Display (Signal to Baseboard)</b>	One VGA is integrated in the CPU One LVDS is integrated in the CPU: <ul style="list-style-type: none"> <li>▪ D2550: 24-bit single-channel LVDS</li> <li>▪ N2600: 18-bit single-channel LVDS</li> </ul>
<b>Ethernet</b>	Realtek RTL8111E PCIe GbE controller
<b>BIOS</b>	UEFI BIOS
<b>Embedded Controller</b>	iWDD
<b>Watchdog Timer</b>	Software programmable supports 1~255 sec. system reset
<b>Expansion (Signal to Baseboard)</b>	Three PCIe x1 Supports PCI

## ICE-CV-D25502/N26002 COM Express Module

Specifications/Model	ICE-CV-D25502/N26002
<b>I/O Interfaces (Signal to Baseboard)</b>	Eight USB 2.0 Two SATA 3Gb/s Two UART (by EC) HD Audio GPIO SMBus I2C LPC SPI
<b>Power Consumption</b>	+12V @ 0.45 A , Vcore_12V @ 1.0A (1.86 GHz Intel® Atom™ D2550 CPU with 2 GB 1066 MHz DDR3 SO-DIMM)
<b>Operating Temperature</b>	-10°C ~ 60°C
<b>Storage Temperature</b>	-20°C ~ 70°C
<b>Humidity (Operating)</b>	5% ~ 95% (non-condensing)
<b>Dimensions</b>	95 mm x 95 mm
<b>Weight (GW/NW)</b>	600 g/200 g

Table 1-2: ICE-CV-D25502/N26002 Specifications

Chapter

2

# Packing List

---

## 2.1 Anti-static Precautions

---



### WARNING!

Static electricity can destroy certain electronics. Make sure to follow the ESD precautions to prevent damage to the product, and injury to the user.

---

Make sure to adhere to the following guidelines:

- **Wear an anti-static wristband:** Wearing an anti-static wristband can prevent electrostatic discharge.
- **Self-grounding:** Touch a grounded conductor every few minutes to discharge any excess static buildup.
- **Use an anti-static pad:** When configuring any circuit board, place it on an anti-static mat.
- **Only handle the edges of the PCB:** Don't touch the surface of the motherboard. Hold the motherboard by the edges when handling.

## 2.2 Unpacking Precautions

When the ICE-CV-D25502/N26002 is unpacked, please do the following:



- Follow the antistatic guidelines above.
- Make sure the packing box is facing upwards when opening.
- Make sure all the packing list items are present.

## 2.3 Packing List

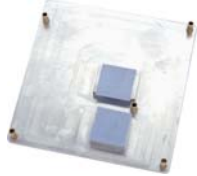
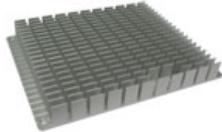

**NOTE:**

If any of the components listed in the checklist below are missing, do not proceed with the installation. Contact the IEI reseller or vendor the ICE-CV-D25502/N26002 was purchased from or contact an IEI sales representative directly by sending an email to [sales@iei.com.tw](mailto:sales@iei.com.tw).

The ICE-CV-D25502/N26002 is shipped with the following components:

Quantity	Item and Part Number	Image
1	ICE-CV-D25502/N26002	
1	Heatspreader plate	
1	Heat sink	
1	One Key Recovery CD	
1	Utility CD	

## ICE-CV-D25502/N26002 COM Express Module

Quantity	Item and Part Number	Image
1	Quick Installation Guide	

**Table 2-1: Packing List**

## 2.4 Optional Items

The following are optional components which may be separately purchased:

Item and Part Number	Image
Baseboard for COM Express Type 2 modules (P/N: ICE-DB-9S-R10)	

**Table 2-2: Optional Items**

Chapter

3

# Connectors

---



## ICE-CV-D25502/N26002 COM Express Module

### 3.1 Peripheral Interface Connectors

This chapter details all the connectors.

#### 3.1.1 ICE-CV-D25502/N26002 Layout

The figure below shows all the connectors.

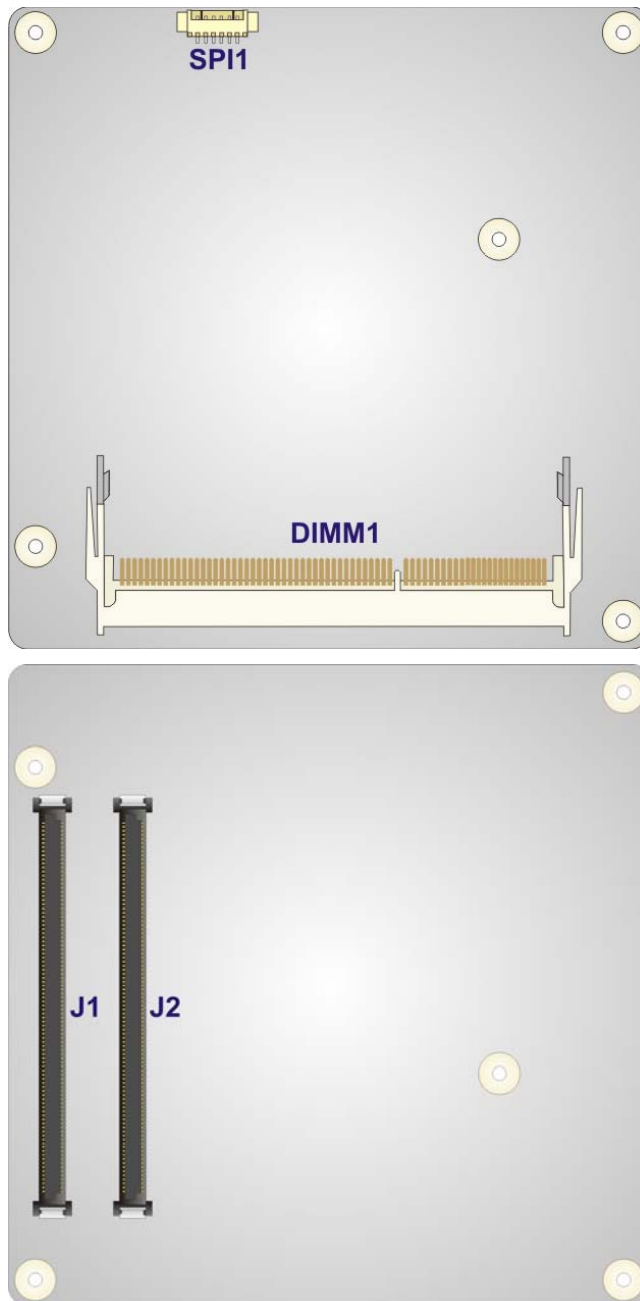

Figure 3-1: Connectors

### 3.1.2 Peripheral Interface Connectors

The table below lists all the connectors on the ICE-CV-D25502/N26002.

Connector	Type	Label
COM Express connector AB	COM Express connector	J1
COM Express connector CD	COM Express connector	J2
SO-DIMM connector	SO-DIMM connector	DIMM1
SPI connector	6-pin connector	SPI1

**Table 3-1: Peripheral Interface Connectors**

## 3.2 Internal Peripheral Connectors

The section describes all of the connectors on the ICE-CV-D25502/N26002.

### 3.2.1 COM Express Connector AB

- CN Label:** J1
- CN Type:** 220-pin COM Express connector
- CN Location:** See **Figure 3-2**
- CN Pinouts:** See **Table 3-2**

The standard COM Express connector AB location and pinouts are shown below.

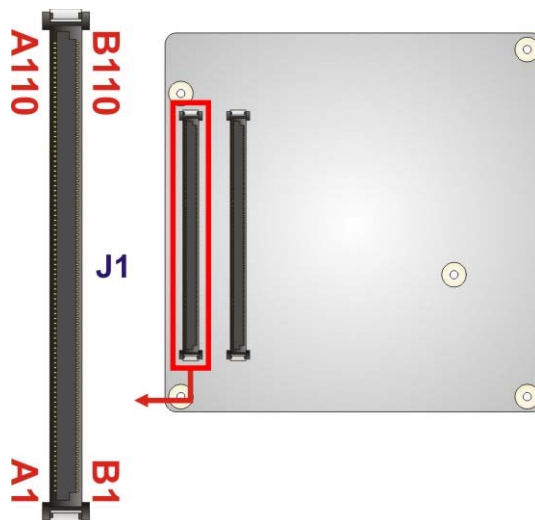

**Figure 3-2: COM Express Connector AB Location**

## ICE-CV-D25502/N26002 COM Express Module

Pin No.	Description	Pin No.	Description
A1	GND0	B1	GND15
A2	GBE0_MDI3-	B2	GBE0_ACT#
A3	GBE0_MDI3+	B3	LPC_FRAME#
A4	GBE0_LINK100#	B4	LPC_AD0
A5	GBE0_LINK1000#	B5	LPC_AD1
A6	GBE0_MDI2-	B6	LPC_AD2
A7	GBE0_MDI2+	B7	LPC_AD3
A8	GBE0_LINK#	B8	LPC_DRQ0#
A9	GBE0_MDI1-	B9	LPC_DRQ1#
A10	GBE0_MDI1+	B10	LPC_CLK
A11	GND1	B11	GND16
A12	GBE0_MDI0-	B12	PWRBTN#
A13	GBE0_MDI0+	B13	SMB_CK
A14	GBE0_CTREF	B14	SMB_DAT
A15	SUS_S3#	B15	SMB_ALERT#
A16	SATA0_TX+	B16	SATA1_TX+
A17	SATA0_TX-	B17	SATA1_TX-
A18	SUS_S4#	B18	SUS_STAT#
A19	SATA0_RX+	B19	SATA1_RX+
A20	SATA0_RX-	B20	SATA1_RX-
A21	GND2	B21	GND17
A22	RSVD	B22	RSVD
A23	RSVD	B23	RSVD
A24	SUS_S5#	B24	PWR_OK
A25	RSVD	B25	RSVD
A26	RSVD	B26	RSVD
A27	BATLOW#	B27	WDT
A28	ATA_ACT#	B28	AC/HD_SDIN2
A29	AC/HD_SYNC	B29	AC/HD_SDIN1
A30	AC/HD_RST#	B30	AC/HD_SDINO
A31	GND3	B31	GND18
A32	AC/HD_BITCLK	B32	SPKR

Pin No.	Description	Pin No.	Description
A33	AC/HD_SDOUT	B33	I2C_CK
A34	BIOS_DISABLE#	B34	I2C_DAT
A35	THRMTRIP#	B35	THRM#
A36	USB6-	B36	USB7-
A37	USB6+	B37	USB7+
A38	USB_6_7_OC#	B38	USB_4_5_OC#
A39	USB4-	B39	USB5-
A40	USB4+	B40	USB5+
A41	GND4	B41	GND19
A42	USB2-	B42	USB3-
A43	USB2+	B43	USB3+
A44	USB_2_3_OC#	B44	USB_0_1_OC#
A45	USB0-	B45	USB1-
A46	USB0+	B46	USB1+
A47	VCC_RTC	B47	EXCD1_PERST#
A48	EXCD0_PERST#	B48	EXCD1_CPPE#
A49	EXCD0_CPPE#	B49	SYS_RESET#
A50	LPC_SERIRQ	B50	CB_RESET#
A51	GND5	B51	GND20
A52	RSVD	B52	RSVD
A53	RSVD	B53	RSVD
A54	GPI0	B54	GPO1
A55	RSVD	B55	RSVD
A56	RSVD	B56	RSVD
A57	GND6	B57	GPO2
A58	RSVD	B58	RSVD
A59	RSVD	B59	RSVD
A60	GND7	B60	GND21
A61	PCIE_TX2+	B61	PCIE_RX2+
A62	PCIE_TX2-	B62	PCIE_RX2-
A63	GPI1	B63	GPO3
A64	PCIE_TX1+	B64	PCIE_RX1+

## ICE-CV-D25502/N26002 COM Express Module

Pin No.	Description	Pin No.	Description
A65	PCIE_TX1-	B65	PCIE_RX1-
A66	GND8	B66	WAKE0#
A67	GPI2	B67	WAKE1#
A68	PCIE_TX0+	B68	PCIE_RX0+
A69	PCIE_TX0-	B69	PCIE_RX0-
A70	GND9	B70	GND22
A71	LVDS_A0+	B71	RSVD
A72	LVDS_A0-	B72	RSVD
A73	LVDS_A1+	B73	RSVD
A74	LVDS_A1-	B74	RSVD
A75	LVDS_A2+	B75	RSVD
A76	LVDS_A2-	B76	RSVD
A77	LVDS_VDD_EN	B77	RSVD
A78	LVDS_A3+	B78	RSVD
A79	LVDS_A3-	B79	LVDS_BKLT_EN
A80	GND10	B80	GND23
A81	LVDS_A_CLK+	B81	RSVD
A82	LVDS_A_CLK-	B82	RSVD
A83	LVDS_I2C_CK	B83	LVDS_BKLT_CTRL
A84	LVDS_I2C_DAT	B84	VCC5SBY1
A85	GPI3	B85	VCC5SBY2
A86	RSVD	B86	VCC5SBY3
A87	RSVD	B87	VCC5SBY4
A88	PCIE0_CK_REF+	B88	BIOS_DIS1#
A89	PCIE0_CK_REF-	B89	VGA_RED
A90	GND11	B90	GND24
A91	SPI_VCC	B91	VGA_GRN
A92	SPI_MISO	B92	VGA_BLU
A93	GPO0	B93	VGA_HSYNC
A94	SPI_CLK	B94	VGA_VSYNC
A95	SPI_MOSI	B95	VGA_I2C_CK
A96	PP_TPM	B96	VGA_I2C_DAT

Pin No.	Description	Pin No.	Description
A97	RSVD	B97	SPI_CS#
A98	RSVD	B98	RSVD
A99	RSVD	B99	RSVD
A100	GND13	B100	GND25
A101	RSVD	B101	FAN_PWMOUT
A102	RSVD	B102	FAN_TACHIN
A103	LID#	B103	SLEEP#
A104	VCC_12V7	B104	VCC_12V16
A105	VCC_12V8	B105	VCC_12V17
A106	VCC_12V9	B106	VCC_12V18
A107	VCC_12V10	B107	VCC_12V19
A108	VCC_12V11	B108	VCC_12V20
A109	VCC_12V12	B109	VCC_12V21
A110	GND14	B110	GND26

**Table 3-2: COM Express Connector AB Pin Definitions**

### 3.2.2 COM Express Connector CD

- CN Label:** J2
- CN Type:** 220-pin COM Express connector
- CN Location:** See **Figure 3-3**
- CN Pinouts:** See **Table 3-3**

The standard COM Express connector CD location and pinouts are shown below.

## ICE-CV-D25502/N26002 COM Express Module

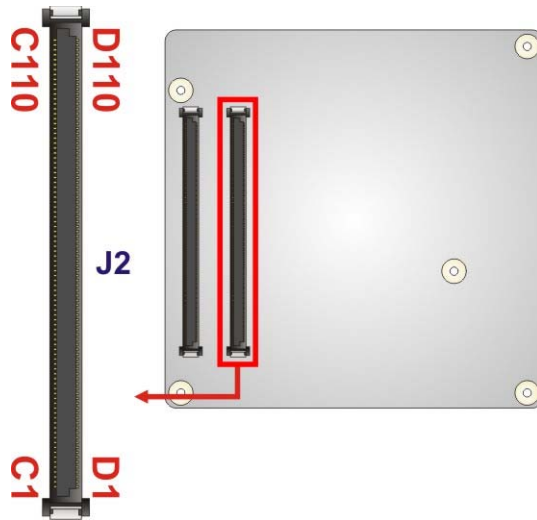

**Figure 3-3: COM Express Connector CD Location**

Pin No.	Description	Pin No.	Description
C1	GND0	D1	GND15
C2	RSVD	D2	RSVD
C3	RSVD	D3	RSVD
C4	RSVD	D4	RSVD
C5	RSVD	D5	RSVD
C6	RSVD	D6	RSVD
C7	RSVD	D7	RSVD
C8	RSVD	D8	RSVD
C9	RSVD	D9	RSVD
C10	RSVD	D10	RSVD
C11	GND1	D11	GND16
C12	RSVD	D12	RSVD
C13	RSVD	D13	RSVD
C14	RSVD	D14	RSVD
C15	PCI_PME#	D15	RSVD
C16	PCI_GNT2#	D16	RSVD
C17	PCI_REQ2#	D17	RSVD
C18	PCI_GNT1#	D18	RSVD
C19	PCI_REQ1#	D19	PCI_GNT3#
C20	PCI_GNT0#	D20	PCI_REQ3#

Pin No.	Description	Pin No.	Description
C21	GND2	D21	GND17
C22	PCI_REQ0#	D22	PCI_AD1
C23	PCI_RESET#	D23	PCI_AD3
C24	PCI_ADO	D24	PCI_AD5
C25	PCI_AD2	D25	PCI_AD7
C26	PCI_AD4	D26	PCI_CBE0#
C27	PCI_AD6	D27	PCI_AD9
C28	PCI_AD8	D28	PCI_AD11
C29	PCI_AD10	D29	PCI_AD13
C30	PCI_AD12	D30	PCI_AD15
C31	GND3	D31	GND18
C32	PCI_AD14	D32	PCI_PAR
C33	PCI_CBE1#	D33	PCI_SERR#
C34	PCI_PERR#	D34	PCI_STOP#
C35	PCI_LOCK#	D35	PCI_TRDY#
C36	PCI_DEVSEL#	D36	PCI_FRAME#
C37	PCI_IRDY#	D37	PCI_AD16
C38	PCI_CBE2#	D38	PCI_AD18
C39	PCI_AD17	D39	PCI_AD20
C40	PCI_AD19	D40	PCI_AD22
C41	GND4	D41	GND19
C42	PCI_AD21	D42	PCI_AD24
C43	PCI_AD23	D43	PCI_AD26
C44	PCI_CBE3#	D44	PCI_AD28
C45	PCI_AD25	D45	PCI_AD30
C46	PCI_AD27	D46	PCI_IRQC#
C47	PCI_AD29	D47	PCI_IRQD#
C48	PCI_AD31	D48	PCI_CLKRUN#
C49	PCI_IRQA#	D49	RSVD
C50	PCI_IRQB#	D50	PCI_CLK
C51	GND5	D51	GND20
C52	RSVD	D52	RSVD



## ICE-CV-D25502/N26002 COM Express Module

Pin No.	Description	Pin No.	Description
C53	RSVD	D53	RSVD
C54	RSVD	D54	PEG_LANE_RV#
C55	RSVD	D55	RSVD
C56	RSVD	D56	RSVD
C57	RSVD	D57	TYPE2#
C58	RSVD	D58	RSVD
C59	RSVD	D59	RSVD
C60	GND7	D60	GND21
C61	RSVD	D61	RSVD
C62	RSVD	D62	RSVD
C63	RSVD	D63	RSVD
C64	RSVD	D64	RSVD
C65	RSVD	D65	RSVD
C66	RSVD	D66	RSVD
C67	RSVD	D67	GND28
C68	RSVD	D68	RSVD
C69	RSVD	D69	RSVD
C70	GND9	D70	GND22
C71	RSVD	D71	RSVD
C72	RSVD	D72	RSVD
C73	RSVD	D73	RSVD
C74	RSVD	D74	RSVD
C75	RSVD	D75	RSVD
C76	GND8	D76	GND29
C77	RSVD	D77	RSVD
C78	RSVD	D78	RSVD
C79	RSVD	D79	RSVD
C80	GND10	D80	GND23
C81	RSVD	D81	RSVD
C82	RSVD	D82	RSVD
C83	RSVD	D83	RSVD
C84	GND6	D84	GND30

Pin No.	Description	Pin No.	Description
C85	RSVD	D85	RSVD
C86	RSVD	D86	RSVD
C87	GND35	D87	GND31
C88	RSVD	D88	RSVD
C89	RSVD	D89	RSVD
C90	GND27	D90	GND24
C91	RSVD	D91	RSVD
C92	RSVD	D92	RSVD
C93	GND11	D93	GND32
C94	RSVD	D94	RSVD
C95	RSVD	D95	RSVD
C96	GND12	D96	GND33
C97	RSVD6	D97	PEG_ENABLE#
C98	RSVD	D98	RSVD
C99	RSVD	D99	RSVD
C100	GND13	D100	GND25
C101	RSVD	D101	RSVD
C102	RSVD	D102	RSVD
C103	GND	D103	GND34
C104	VCC_12V1	D104	VCC_12V7
C105	VCC_12V2	D105	VCC_12V8
C106	VCC_12V3	D106	VCC_12V9
C107	VCC_12V4	D107	VCC_12V10
C108	VCC_12V5	D108	VCC_12V11
C109	VCC_12V6	D109	VCC_12V12
C110	GND14	D110	GND26

**Table 3-3: COM Express Connector CD Pin Definitions**

## ICE-CV-D25502/N26002 COM Express Module

### 3.2.3 SO-DIMM Connector

- CN Label:** DIMM1
- CN Type:** 204-pin DDR3 SO-DIMM connector
- CN Location:** See **Figure 3-4**

The SO-DIMM connector is for installing memory on the system.

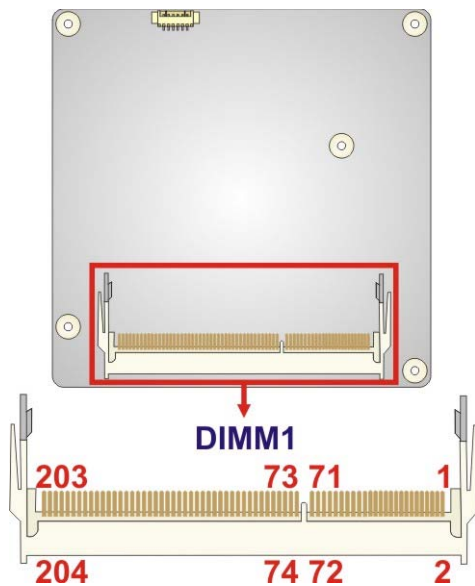
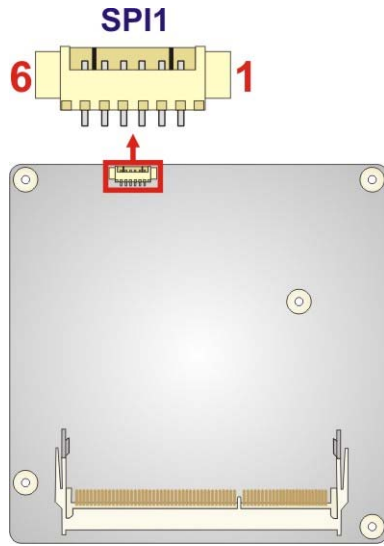

**Figure 3-4: SO-DIMM Connector Location**

### 3.2.4 SPI Connector

- CN Label:** SPI1
- CN Type:** 6-pin connector
- CN Location:** See **Figure 3-5**
- CN Pinouts:** See **Table 3-4**

The SPI connector is for flashing new BIOS onto the SPI BIOS chip.



**Figure 3-5: SPI Flash Connector Location**

Pin	Description
1	SPI_VCC
2	SPI_CS#
3	SPI_MISO
4	SPI_CLK
5	SPI_MOSI
6	GND

**Table 3-4: SPI Flash Connector Pinouts**

Chapter

4

# Installation

---

## 4.1 Anti-static Precautions

---



### WARNING:

Failure to take ESD precautions during the installation of the ICE-CV-D25502/N26002 may result in permanent damage to the ICE-CV-D25502/N26002 and severe injury to the user.

---

Electrostatic discharge (ESD) can cause serious damage to electronic components, including the ICE-CV-D25502/N26002. Dry climates are especially susceptible to ESD. It is therefore critical that whenever the ICE-CV-D25502/N26002 or any other electrical component is handled, the following anti-static precautions are strictly adhered to.

- **Wear an anti-static wristband:** - Wearing a simple anti-static wristband can help to prevent ESD from damaging the board.
- **Self-grounding:** - Before handling the board touch any grounded conducting material. During the time the board is handled, frequently touch any conducting materials that are connected to the ground.
- **Use an anti-static pad:** When configuring the ICE-CV-D25502/N26002, place it on an anti-static pad. This reduces the possibility of ESD damaging the ICE-CV-D25502/N26002.
- **Only handle the edges of the PCB:-:** When handling the PCB, hold the PCB by the edges.

## 4.2 Installation Considerations

---



### NOTE:

The following installation notices and installation considerations should be read and understood before installation. All installation notices must be strictly adhered to. Failing to adhere to these precautions may lead to severe damage and injury to the person performing the installation.

---

## ICE-CV-D25502/N26002 COM Express Module



### **WARNING:**

The installation instructions described in this manual should be carefully followed in order to prevent damage to the components and injury to the user.

Before and during the installation please **DO** the following:

- Read the user manual:
  - The user manual provides a complete description of the ICE-CV-D25502/N26002 installation instructions and configuration options.
- Wear an electrostatic discharge cuff (ESD):
  - Electronic components are easily damaged by ESD. Wearing an ESD cuff removes ESD from the body and helps prevent ESD damage.
- Place the ICE-CV-D25502/N26002 on an antistatic pad:
  - When installing or configuring the motherboard, place it on an antistatic pad. This helps to prevent potential ESD damage.
- Turn all power to the ICE-CV-D25502/N26002 off:
  - When working with the ICE-CV-D25502/N26002, make sure that it is disconnected from all power supplies and that no electricity is being fed into the system.

Before and during the installation of the ICE-CV-D25502/N26002 **DO NOT**:

- Remove any of the stickers on the PCB board. These stickers are required for warranty validation.
- Use the product before verifying all the cables and power connectors are properly connected.
- Allow screws to come in contact with the PCB circuit, connector pins, or its components.

### 4.3 SO-DIMM Installation



#### WARNING:

Using incorrectly specified SO-DIMM may cause permanent damage to the ICE-CV-D25502/N26002. Please make sure the purchased SO-DIMM complies with the memory specifications of the ICE-CV-D25502/N26002. SO-DIMM specifications compliant with the ICE-CV-D25502/N26002 are listed in Chapter 1.

To install a SO-DIMM into a SO-DIMM socket, please follow the steps below and refer to **Figure 4-1**.

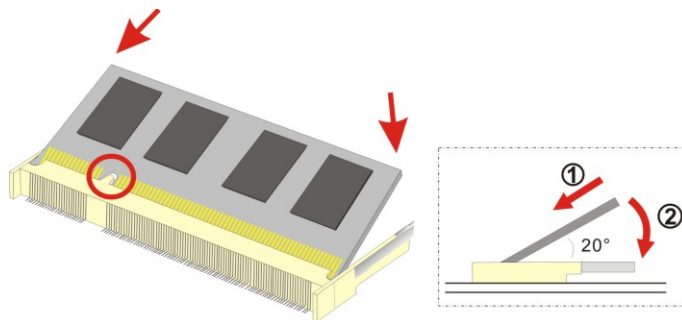

**Figure 4-1: SO-DIMM Installation**

- Step 1:** **Locate the SO-DIMM socket.** Place the ICE-CV-D25502/N26002 on an anti-static pad with the solder side facing up.
- Step 2:** **Align the SO-DIMM with the socket.** The SO-DIMM must be oriented in such a way that the notch in the middle of the SO-DIMM must be aligned with the plastic bridge in the socket.
- Step 3:** **Insert the SO-DIMM.** Push the SO-DIMM chip into the socket at an angle. (See **Figure 4-1**)
- Step 4:** **Open the SO-DIMM socket arms.** Gently pull the arms of the SO-DIMM socket out and push the rear of the SO-DIMM down. (See **Figure 4-1**)



## ICE-CV-D25502/N26002 COM Express Module

**Step 5:** Secure the SO-DIMM. Release the arms on the SO-DIMM socket. They clip into place and secure the SO-DIMM in the socket.

### 4.4 Mounting the ICE-CV-D25502/N26002 to an Optional Baseboard

---



#### NOTE:

Baseboard can be designed by the end user, customized by IEI, or purchased from IEI. For more information visit the IEI website ([www.ieiworld.com](http://www.ieiworld.com)) or contact an IEI sales representative.

---



#### WARNING:

Never run the COM Express module without the heat sink. The heatspreader plate shipped with the ICE-CV-D25502/N26002 acts as a thermal interface between the module and the heat sink. The heat sink must be installed on the heatspreader plate to maintain proper operating temperatures. Make sure to maintain the heatspreader plate temperature under 60°C in operation.

---

Follow the steps below to install the ICE-CV-D25502/N26002 to the optional baseboard.

**Step 1:** Align the two COM Express connectors on the reverse side of ICE-CV-D25502/N26002 with the corresponding connectors on the baseboard. Gently push the COM Express module down to ensure the connectors are properly connected (**Figure 4-2**).

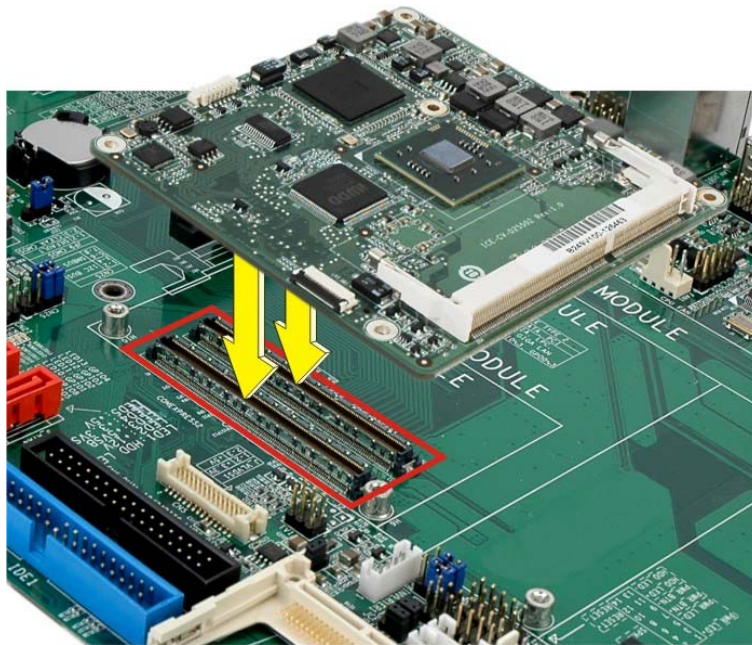

**Figure 4-2: Connect the COM Express Connectors**

**Step 2:** Place the supplied heat sink on the heatspreader plate, aligning the four retention screw holes (**Figure 4-3**). Ensure to apply thermal paste to the heat sink or heatspreader plate for optimum heat dissipation.

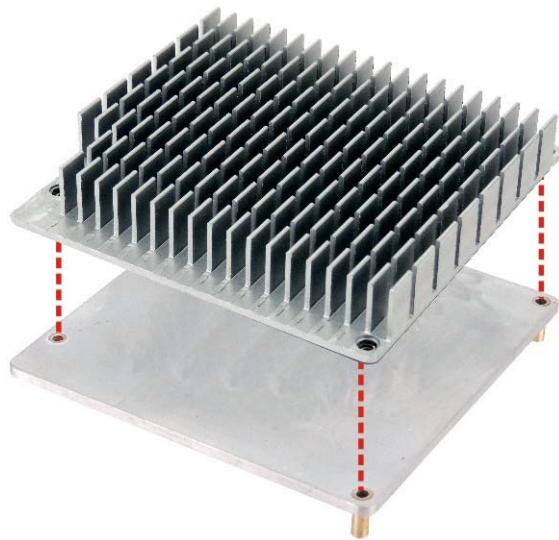

**Figure 4-3: Attach the Heat Sink to the Heatspreader Plate**

## ICE-CV-D25502/N26002 COM Express Module

- Step 3:** Place the heatspreader plate with the heat sink on the ICE-CV-D25502/N26002, aligning the four retention screw holes (**Figure 4-4**).
- Step 4:** Secure the heatspreader plate with the heat sink onto the baseboard with four retention screws (**Figure 4-4**).

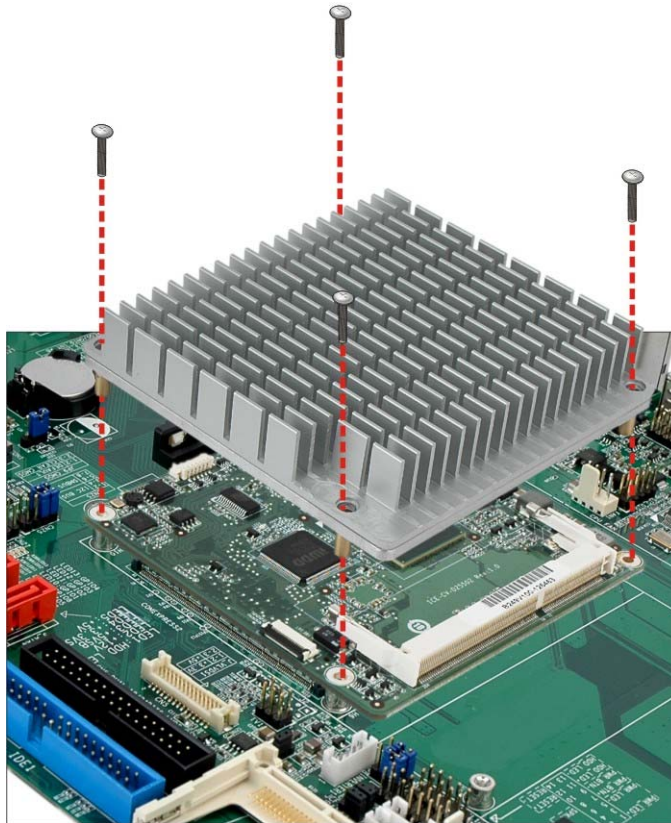

**Figure 4-4: Secure the Heatspreader Plate with the Heat Sink to the Baseboard**

Chapter

5

# BIOS

---

## 5.1 Introduction

The BIOS is programmed onto the BIOS chip. The BIOS setup program allows changes to certain system settings. This chapter outlines the options that can be changed.

### 5.1.1 Starting Setup

The UEFI BIOS is activated when the computer is turned on. The setup program can be activated in one of two ways.

1. Press the **DEL** or **F2** key as soon as the system is turned on or
2. Press the **DEL** or **F2** key when the “**Press DEL or F2 to enter SETUP**” message appears on the screen.

If the message disappears before the **DEL** or **F2** key is pressed, restart the computer and try again.

### 5.1.2 Using Setup

Use the arrow keys to highlight items, press **ENTER** to select, use the PageUp and PageDown keys to change entries, press **F1** for help and press **ESC** to quit. Navigation keys are shown in.

Key	Function
Up arrow	Move to previous item
Down arrow	Move to next item
Left arrow	Move to the item on the left hand side
Right arrow	Move to the item on the right hand side
+	Increase the numeric value or make changes
-	Decrease the numeric value or make changes
Page Up key	Move to the next page
Page Dn key	Move to the previous page

Key	Function
Esc key	Main Menu – Quit and not save changes into CMOS Status Page Setup Menu and Option Page Setup Menu -- Exit current page and return to Main Menu
F1	General help, only for Status Page Setup Menu and Option Page Setup Menu
F2	Load previous values
F3	Load optimized defaults
F4	Save changes and Exit BIOS

**Table 5-1: BIOS Navigation Keys**

### 5.1.3 Getting Help

When **F1** is pressed a small help window describing the appropriate keys to use and the possible selections for the highlighted item appears. To exit the Help Window press **Esc** or the **F1** key again.

### 5.1.4 Unable to Reboot after Configuration Changes

If the computer cannot boot after changes to the system configuration is made, CMOS defaults. Use the jumper described in Chapter 4.

### 5.1.5 BIOS Menu Bar

The **menu bar** on top of the BIOS screen has the following main items:

- Main – Changes the basic system configuration.
- Advanced – Changes the advanced system settings.
- Chipset – Changes the chipset settings.
- Boot – Changes the system boot configuration.
- Security – Sets User and Supervisor Passwords.
- Save & Exit – Selects exit options and loads default settings.

The following sections completely describe the configuration options found in the menu items at the top of the BIOS screen and listed above.

## ICE-CV-D25502/N26002 COM Express Module

### 5.2 Main

The **Main** BIOS menu (**BIOS Menu 1**) appears when the **BIOS Setup** program is entered. The **Main** menu gives an overview of the basic system information.

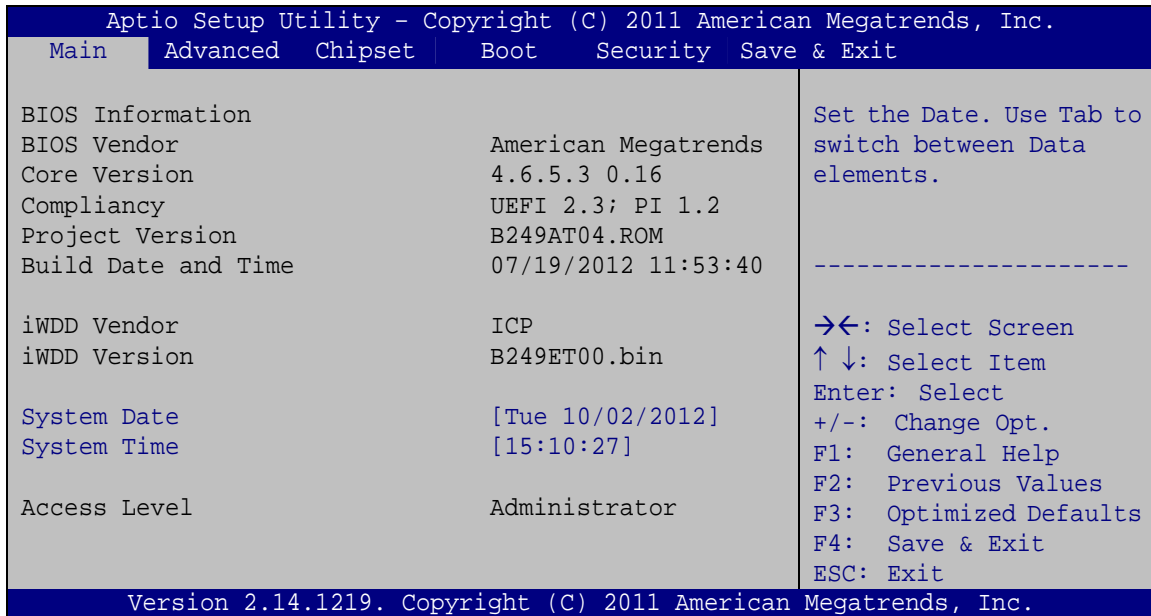

#### BIOS Menu 1: Main

##### → System Overview

The **BIOS Information** lists a brief summary of the BIOS. The fields in **BIOS Information** cannot be changed. The items shown in the system overview include:

- **BIOS Vendor:** Installed BIOS vendor
- **Core Version:** Current BIOS version
- **Project Version:** the board version
- **Build Date and Time:** Date and time the current BIOS version was made

The System Overview field also has two user configurable fields:

##### → System Date [xx/xx/xx]

Use the **System Date** option to set the system date. Manually enter the day, month and year.

→ **System Time [xx:xx:xx]**

Use the **System Time** option to set the system time. Manually enter the hours, minutes and seconds.

### 5.3 Advanced

Use the **Advanced** menu (**BIOS Menu 2**) to configure the CPU and peripheral devices through the following sub-menus:



**WARNING:**

Setting the wrong values in the sections below may cause the system to malfunction. Make sure that the settings made are compatible with the hardware.

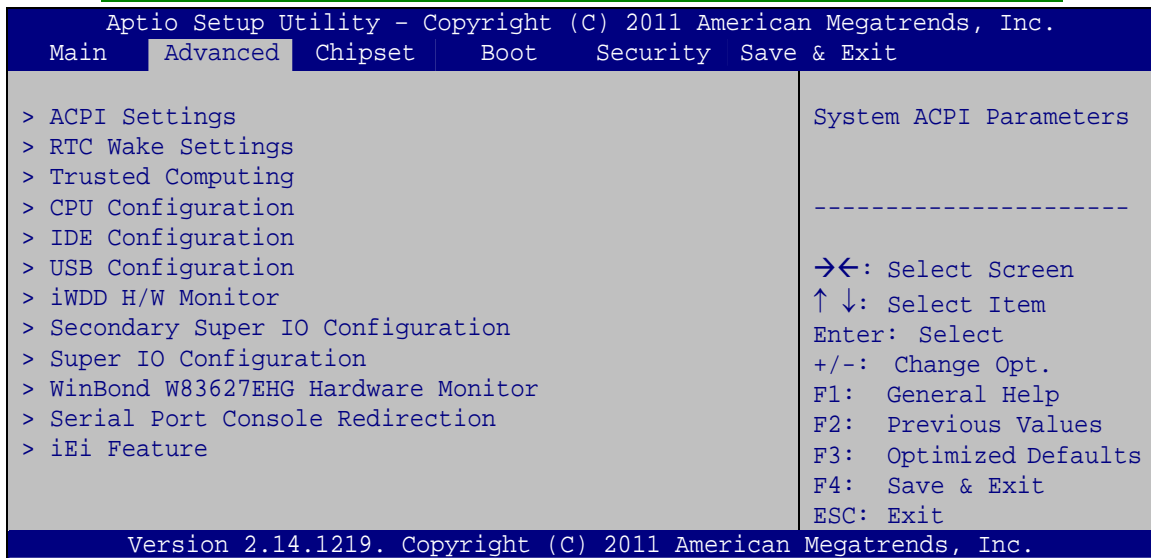

**BIOS Menu 2: Advanced**

#### 5.3.1 ACPI Settings

The **ACPI Settings** menu (**BIOS Menu 3**) configures the Advanced Configuration and Power Interface (ACPI) options.



## ICE-CV-D25502/N26002 COM Express Module

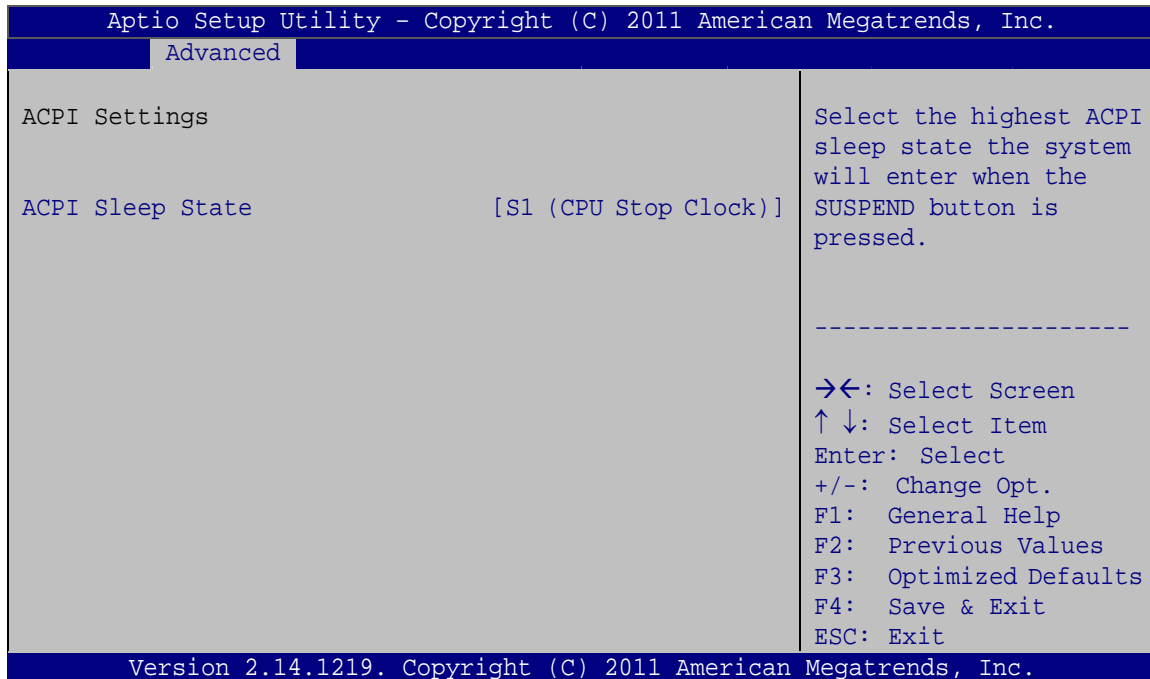

### BIOS Menu 3: ACPI Settings

#### → ACPI Sleep State [S1 (CPU Stop Clock)]

Use the **ACPI Sleep State** option to specify the sleep state the system enters when it is not being used.

- **S1 (CPU Stop DEFAULT Clock)** The system enters S1 (POS) sleep state. The system appears off. The CPU is stopped; RAM is refreshed; the system is running in a low power mode.
- **S3 (Suspend to RAM)** The caches are flushed and the CPU is powered off. Power to the RAM is maintained. The computer returns slower to a working state, but more power is saved.

### 5.3.2 RTC Wake Settings

The **RTC Wake Settings** menu (**BIOS Menu 4**) enables the system to wake at the specified time.

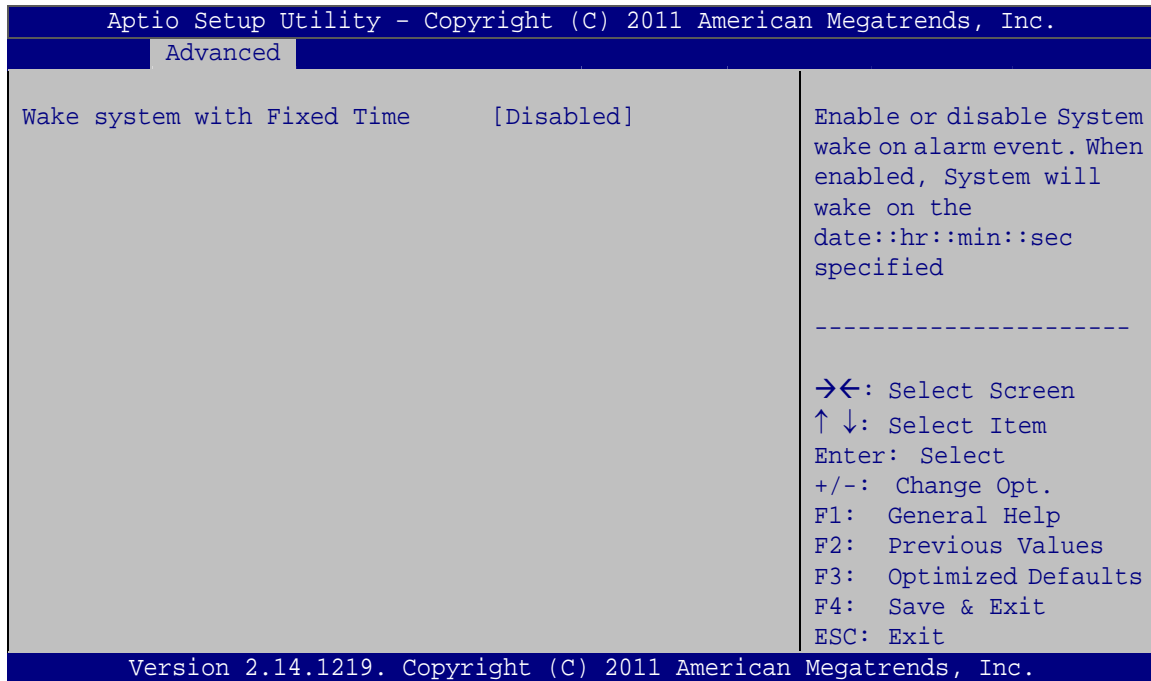
**BIOS Menu 4: RTC Wake Settings**
**→ Wake system with Fixed Time [Disabled]**

Use the **Wake system with Fixed Time** option to enable or disable the system wake on alarm event.

→ **Disabled**      **DEFAULT**      The real time clock (RTC) cannot generate a wake event

→ **Enabled**      If selected, the **Wake up every day** option appears allowing you to enable to disable the system to wake every day at the specified time. Besides, the following options appear with values that can be selected:

Wake up date

Wake up hour

Wake up minute

Wake up second

After setting the alarm, the computer turns itself on from a suspend state when the alarm goes off.

## ICE-CV-D25502/N26002 COM Express Module

### 5.3.3 Trusted Computing

Use the **Trusted Computing** menu (**BIOS Menu 5**) to configure settings related to the Trusted Computing Group (TCG) Trusted Platform Module (TPM).

```

Aptio Setup Utility - Copyright (C) 2011 American Megatrends, Inc.
  Advanced
-----
Configuration
Security Device Support          [Disable]
Current Status Information
NO Security Device Found

Enables or Disables BIOS support for security device. O.S. will not show Security Device. TCG EFI protocol and INT1A interface will not be available.

-----

-><: Select Screen
↑↓: Select Item
Enter: Select
+/-: Change Opt.
F1: General Help
F2: Previous Values
F3: Optimized Defaults
F4: Save & Exit
ESC: Exit

Version 2.14.1219. Copyright (C) 2011 American Megatrends, Inc.
  
```

#### BIOS Menu 5: Trusted Computing

##### ➔ Security Device Support [Disable]

Use the **Security Device Support** option to configure support for the TPM.

- ➔ **Disable**    DEFAULT    TPM support is disabled.
- ➔ **Enable**                    TPM support is enabled.

### 5.3.4 CPU Configuration

Use the **CPU Configuration** menu (**BIOS Menu 6**) to view detailed CPU specifications and configure the CPU.

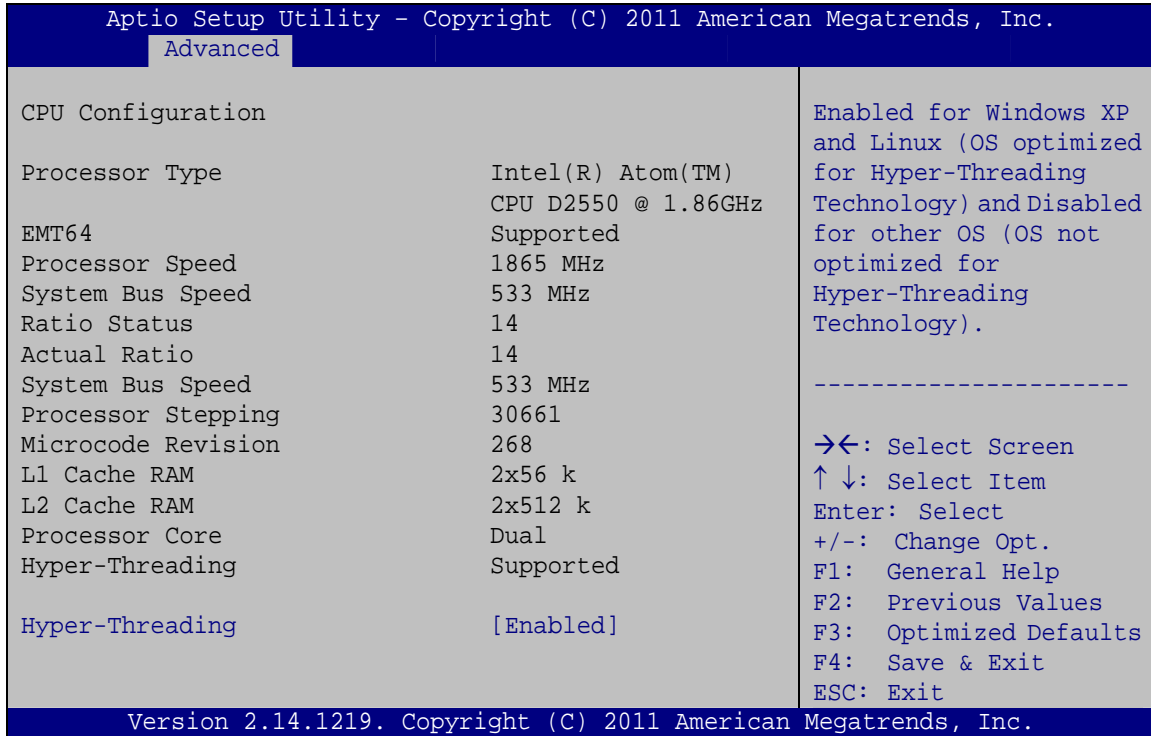

#### BIOS Menu 6: CPU Configuration

The CPU Configuration menu (**BIOS Menu 6**) lists the following CPU details:

- **Processor Type:** Lists the brand name of the CPU being used.
- **EMT64:** Indicates if EMT64 is supported by the CPU.
- **Processor Speed:** Lists the CPU processing speed.
- **System Bus Speed:** Lists the system bus speed.
- **Ratio Status:** Lists the ratio status.
- **Actual Ratio:** Lists the ratio of the frequency to the clock speed.
- **Processor Stepping:** Lists the CPU ID.
- **Microcode Revision:** Lists the microcode revision.
- **L1 Cache RAM:** Lists the CPU L1 cache size.
- **L2 Cache RAM:** Lists the CPU L2 cache size.
- **Processor Core:** Lists the number of the processor core.
- **Hyper-Threading:** Indicates if Intel HT Technology is supported by the CPU.

## ICE-CV-D25502/N26002 COM Express Module

### → Hyper-Threading [Enabled]

Use the **Hyper-Threading** BIOS option to enable or disable the Intel Hyper-Threading Technology.

- **Disabled**                      Disables the Intel Hyper-Threading Technology.
- **Enabled**    **DEFAULT**      Enables the Intel Hyper-Threading Technology.

### 5.3.5 IDE Configuration

Use the **IDE Configuration** menu (**BIOS Menu 7**) to change and/or set the configuration of the SATA devices installed in the system.

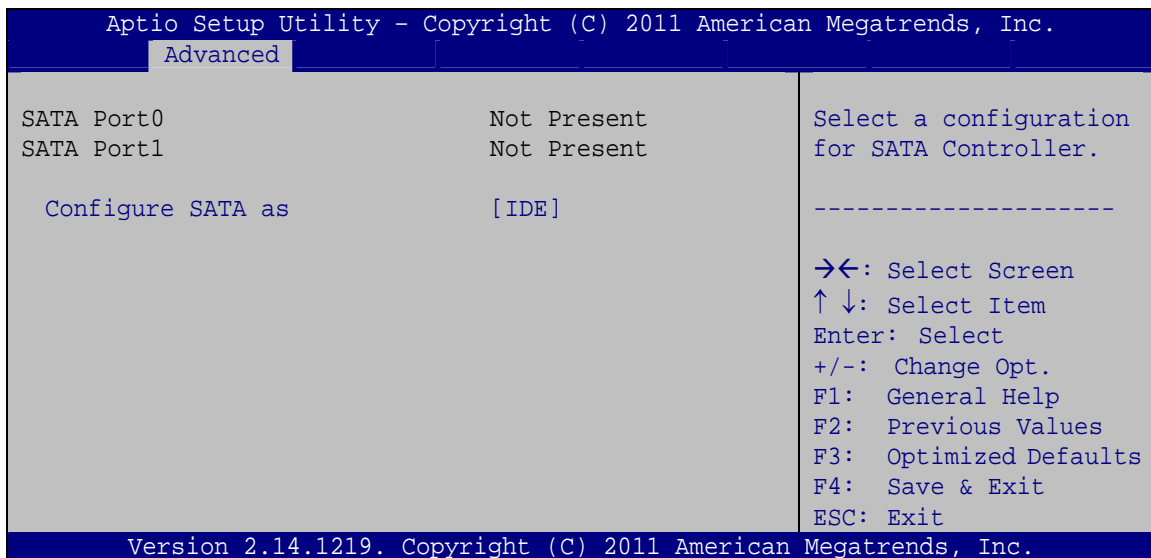

#### BIOS Menu 7: IDE Configuration

### → Configure SATA as [IDE]

Use the **Configure SATA as** option to configure SATA devices as normal IDE or AHCI devices.

- **IDE**                      **DEFAULT**      Configures SATA devices as normal IDE device.
- **AHCI**                      Configures SATA devices as AHCI device.

### 5.3.6 USB Configuration

Use the **USB Configuration** menu (**BIOS Menu 8**) to read USB configuration information and configure the USB settings.

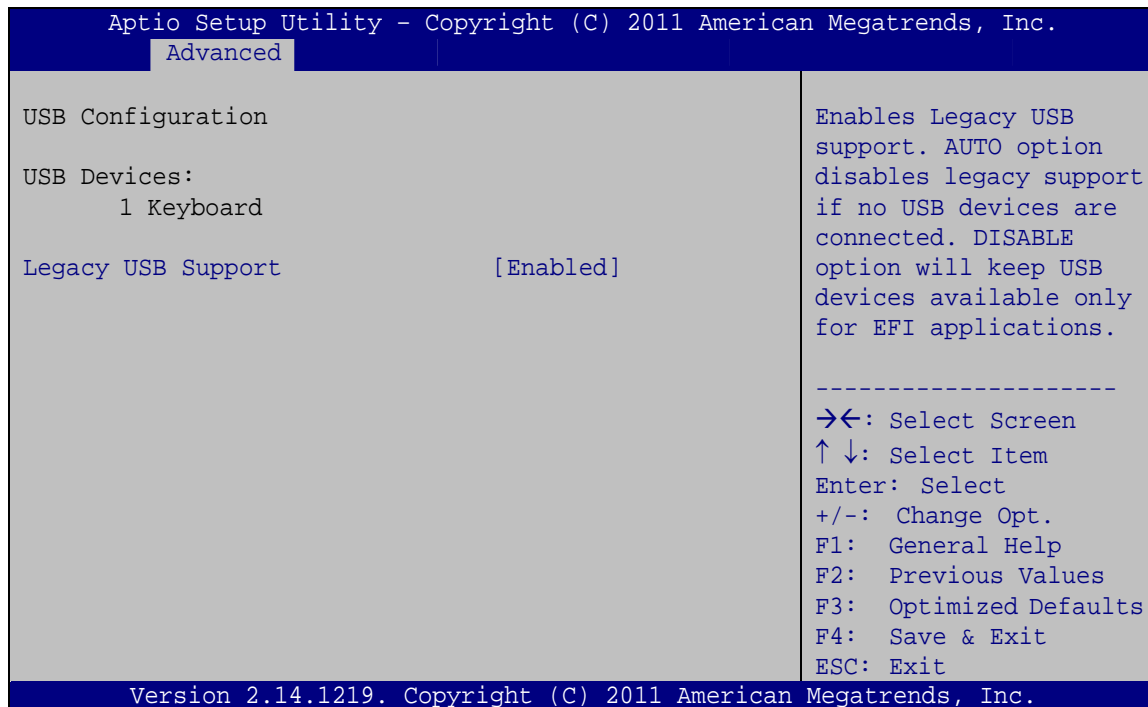

#### BIOS Menu 8: USB Configuration

##### → USB Devices

The **USB Devices** field lists the USB devices that are enabled on the system

##### → Legacy USB Support [Enabled]

Use the **Legacy USB Support** BIOS option to enable USB mouse and USB keyboard support.

Normally if this option is not enabled, any attached USB mouse or USB keyboard does not become available until a USB compatible operating system is fully booted with all USB drivers loaded. When this option is enabled, any attached USB mouse or USB keyboard can control the system even when there is no USB driver loaded onto the system.

→ **Enabled**    **DEFAULT**    Legacy USB support enabled

## ICE-CV-D25502/N26002 COM Express Module

- ➔ **Disabled** Legacy USB support disabled
- ➔ **Auto** Legacy USB support disabled if no USB devices are connected

### 5.3.7 iWDD H/W Monitor

The **iWDD H/W Monitor** menu (**BIOS Menu 9**) allows configuring the CPU fan speed value and displays the CPU fan speed and system voltages.

```

Aptio Setup Utility - Copyright (C) 2011 American Megatrends, Inc.
-----
Advanced
-----
PC Health Status
CPU FAN1 Speed           : N/A
CPU Fan Speed Value     : 100
-----
VINO(+1.5V_DDR3)        : +1.513 V
VIN1(+VCC_CPU)          : +1.196 V
VIN2(+V1.05S)           : +1.058 V
VIN3(+V1.5S)            : +1.507 V
VIN4(+V1.8S)            : +1.780 V
VIN5(+V3.3S)            : +2.997 V
VIN6(+V5S)              : +5.160 V
VIN7(+V12S)             : +12.052 V
-----
Set CPU Fan Speed Value
0~127
-----
-><: Select Screen
↑↓: Select Item
Enter: Select
+/-: Change Opt.
F1: General Help
F2: Previous Values
F3: Optimized Defaults
F4: Save & Exit
ESC: Exit
-----
Version 2.14.1219. Copyright (C) 2011 American Megatrends, Inc.

```

#### BIOS Menu 9: iWDD H/W Monitor

##### ➔ CPU Fan Speed Value

Use the + or – key to change the CPU fan speed value. Enter a decimal number between 0 and 127.

### 5.3.8 Secondary Super IO Configuration

Use the **Secondary Super IO Configuration** menu (BIOS Menu 10) to set or change the configurations for the serial ports.

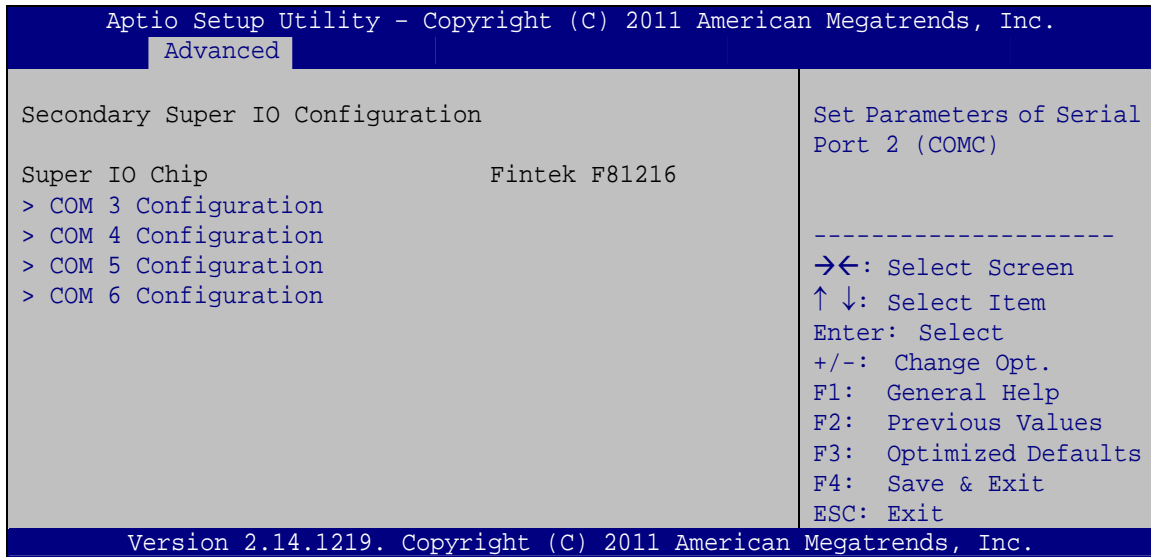

**BIOS Menu 10: Secondary Super IO Configuration**

#### 5.3.8.1 COM n Configuration

Use the **Serial Port n Configuration** menu (BIOS Menu 11) to configure the serial port n.

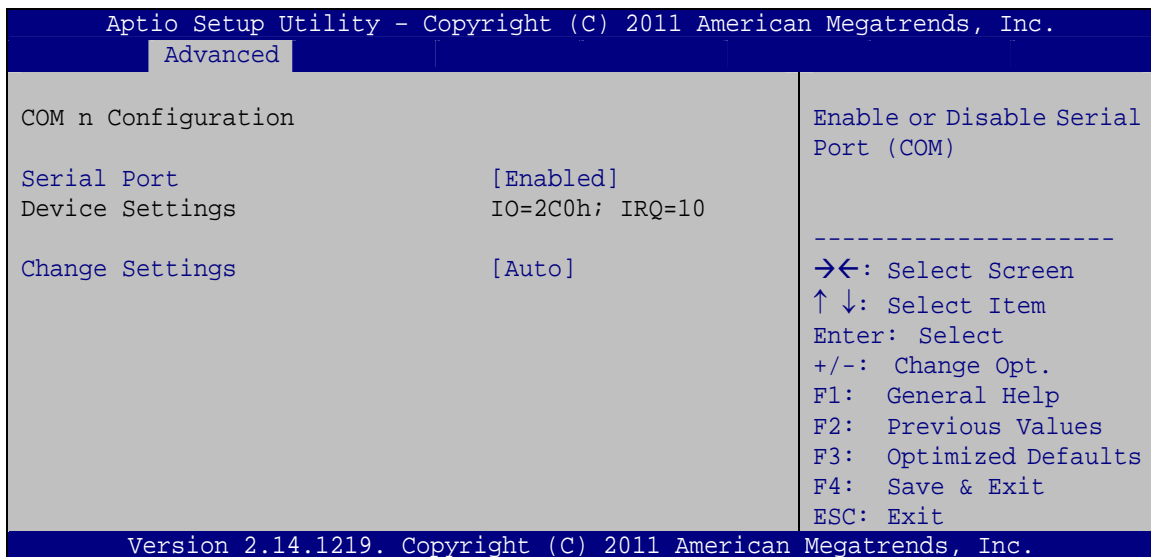

**BIOS Menu 11: COM n Configuration Menu**



## ICE-CV-D25502/N26002 COM Express Module

### 5.3.8.1.1 COM 3 Configuration

#### → Serial Port [Enabled]

Use the **Serial Port** option to enable or disable the serial port.

- **Disabled**                      Disable the serial port
- **Enabled**      **DEFAULT**      Enable the serial port

#### → Change Settings [Auto]

Use the **Change Settings** option to change the serial port IO port address and interrupt address.

- **Auto**              **DEFAULT**      The serial port IO port address and interrupt address are automatically detected.
- **IO=2C0h;**  
**IRQ=10**                      Serial Port I/O port address is 2C0h and the interrupt address is IRQ10
- **IO=2C0h;**  
**IRQ=10, 11**                      Serial Port I/O port address is 2C0h and the interrupt address is IRQ10, 11
- **IO=2C8h;**  
**IRQ=10, 11**                      Serial Port I/O port address is 2C8h and the interrupt address is IRQ10, 11
- **IO=2D0h;**  
**IRQ=10, 11**                      Serial Port I/O port address is 2D0h and the interrupt address is IRQ10, 11
- **IO=2D8h;**  
**IRQ=10, 11**                      Serial Port I/O port address is 2D8h and the interrupt address is IRQ10, 11

### 5.3.8.1.2 COM 4 Configuration

#### → Serial Port [Enabled]

Use the **Serial Port** option to enable or disable the serial port.

- **Disabled**                      Disable the serial port
- **Enabled**      **DEFAULT**      Enable the serial port

**→ Change Settings [Auto]**

Use the **Change Settings** option to change the serial port IO port address and interrupt address.

- |                                  |                |   |
|----------------------------------|----------------|---|
| <b>→ Auto</b>                    | <b>DEFAULT</b> | The serial port IO port address and interrupt address are automatically detected. |
| <b>→ IO=2C8h;<br/>IRQ=10</b>     |                | Serial Port I/O port address is 2C8h and the interrupt address is IRQ10           |
| <b>→ IO=2C0h;<br/>IRQ=10, 11</b> |                | Serial Port I/O port address is 2C0h and the interrupt address is IRQ10, 11       |
| <b>→ IO=2C8h;<br/>IRQ=10, 11</b> |                | Serial Port I/O port address is 2C8h and the interrupt address is IRQ10, 11       |
| <b>→ IO=2D0h;<br/>IRQ=10, 11</b> |                | Serial Port I/O port address is 2D0h and the interrupt address is IRQ10, 11       |
| <b>→ IO=2D8h;<br/>IRQ=10, 11</b> |                | Serial Port I/O port address is 2D8h and the interrupt address is IRQ10, 11       |

**5.3.8.1.3 COM 5 Configuration**
**→ Serial Port [Enabled]**

Use the **Serial Port** option to enable or disable the serial port.

- |                   |                |                         |
|-------------------|----------------|-------------------------|
| <b>→ Disabled</b> |                | Disable the serial port |
| <b>→ Enabled</b>  | <b>DEFAULT</b> | Enable the serial port  |

**→ Change Settings [Auto]**

Use the **Change Settings** option to change the serial port IO port address and interrupt address.

- |               |                |   |
|---------------|----------------|---|
| <b>→ Auto</b> | <b>DEFAULT</b> | The serial port IO port address and interrupt address are automatically detected. |
|---------------|----------------|---|

## ICE-CV-D25502/N26002 COM Express Module

- ➔ **IO=2D0h;**  
**IRQ=10**                      Serial Port I/O port address is 2D0h and the interrupt address is IRQ10
- ➔ **IO=2C0h;**  
**IRQ=10, 11**                Serial Port I/O port address is 2C0h and the interrupt address is IRQ10, 11
- ➔ **IO=2C8h;**  
**IRQ=10, 11**                Serial Port I/O port address is 2C8h and the interrupt address is IRQ10, 11
- ➔ **IO=2D0h;**  
**IRQ=10, 11**                Serial Port I/O port address is 2D0h and the interrupt address is IRQ10, 11
- ➔ **IO=2D8h;**  
**IRQ=10, 11**                Serial Port I/O port address is 2D8h and the interrupt address is IRQ10, 11

### 5.3.8.1.4 COM 6 Configuration

#### ➔ Serial Port [Enabled]

Use the **Serial Port** option to enable or disable the serial port.

- ➔ **Disabled**                      Disable the serial port
- ➔ **Enabled**                      **DEFAULT**                      Enable the serial port

#### ➔ Change Settings [Auto]

Use the **Change Settings** option to change the serial port IO port address and interrupt address.

- ➔ **Auto**                      **DEFAULT**                      The serial port IO port address and interrupt address are automatically detected.
- ➔ **IO=2D8h;**  
**IRQ=10**                      Serial Port I/O port address is 2D8h and the interrupt address is IRQ10
- ➔ **IO=2C0h;**  
**IRQ=10, 11**                Serial Port I/O port address is 2C0h and the interrupt address is IRQ10, 11
- ➔ **IO=2C8h;**  
**IRQ=10, 11**                Serial Port I/O port address is 2C8h and the interrupt address is IRQ10, 11

- ➔ **IO=2D0h;**                      Serial Port I/O port address is 2D0h and the interrupt address is IRQ10, 11  
     **IRQ=10, 11**
- ➔ **IO=2D8h;**                      Serial Port I/O port address is 2D8h and the interrupt address is IRQ10, 11  
     **IRQ=10, 11**

➔ **Select RS232/422/485 [RS232]**

Use the **Select RS232/422/485** option to select the serial port mode.

- ➔ **RS232**                      **DEFAULT**                      Enables serial port RS-232 support.
- ➔ **RS422/RS485**                      Enables serial port RS-422/485 support.

### 5.3.9 Super IO Configuration

Use the **Super IO Configuration** menu (**BIOS Menu 12**) to set or change the configurations for the serial ports.

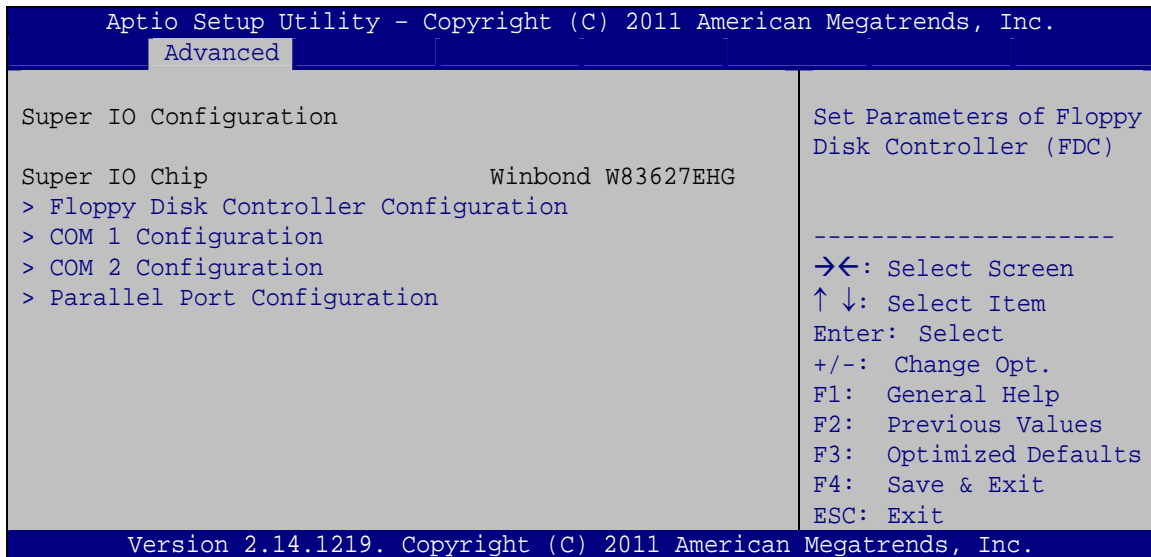

**BIOS Menu 12: Super IO Configuration**

## ICE-CV-D25502/N26002 COM Express Module

### 5.3.9.1 Floppy Disk Controller Configuration

Use the **Floppy Disk Controller Configuration** menu (**BIOS Menu 14**) to configure the floppy disk controller.

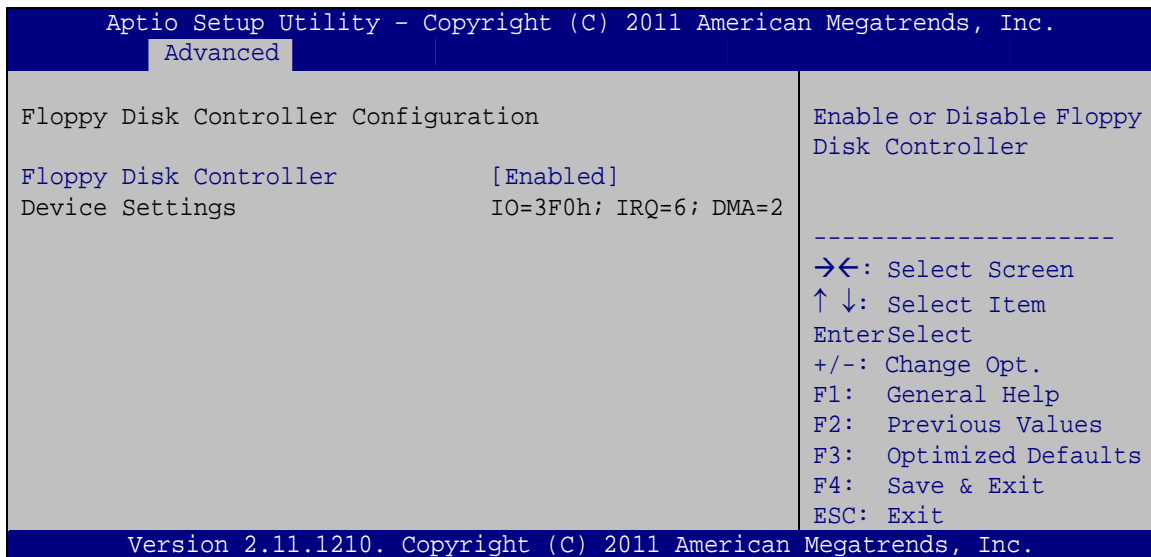

#### BIOS Menu 13: Floppy Disk Controller Configuration Menu

##### → Floppy Disk Controller [Enabled]

Use the **Floppy Disk Controller** option to enable or disable the floppy disk controller.

- **Disabled** Floppy disk controller disabled
- **Enabled** **DEFAULT** Floppy disk controller enabled

##### → Change Settings [Auto]

Use the **Change Settings** option to select an optimal setting for the device.

- **Auto** **DEFAULT** The IO port address, interrupt address and DMA are automatically detected.
- **IO=3F0h;**  
**IRQ=6;**  
**DMA=2** The I/O port address is 3F0h; the interrupt address is IRQ6; the DMA is 2.

➔ **Device Mode [Read Write]**

Use the **Device Mode** option to select the device mode.

- ➔ **Read Write**      **DEFAULT**      Enables for normal operation.
- ➔ **Write Protect**                      Enables for read only operation.

### 5.3.9.2 COM n Configuration

Use the **COM n Configuration** menu (**BIOS Menu 14**) to configure the serial port n.

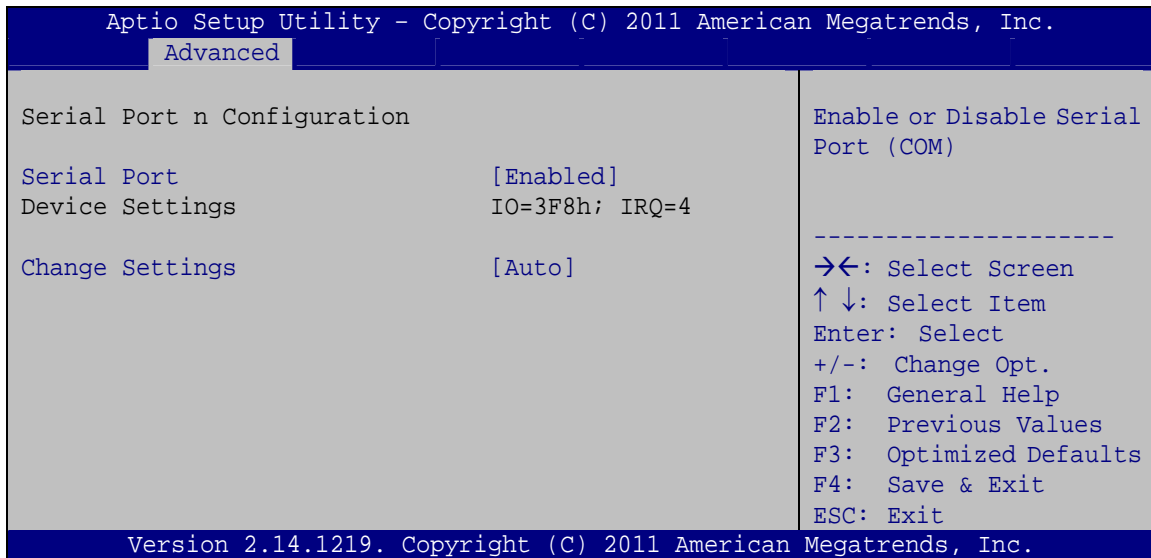

**BIOS Menu 14: COM n Configuration Menu**

#### 5.3.9.2.1 COM 1 Configuration

➔ **Serial Port [Enabled]**

Use the **Serial Port** option to enable or disable the serial port.

- ➔ **Disabled**                      Disable the serial port
- ➔ **Enabled**      **DEFAULT**      Enable the serial port

➔ **Change Settings [Auto]**

Use the **Change Settings** option to change the serial port IO port address and interrupt address.

## ICE-CV-D25502/N26002 COM Express Module

- **Auto**      **DEFAULT**      The serial port IO port address and interrupt address are automatically detected.
- **IO=3F8h;**  
**IRQ=4**      Serial Port I/O port address is 3F8h and the interrupt address is IRQ4
- **IO=3F8h;**  
**IRQ=3, 4,**  
**5, 6, 7, 10,**  
**11, 12**      Serial Port I/O port address is 3F8h and the interrupt address is IRQ3, 4, 5, 6, 7, 10, 11, 12
- **IO=2F8h;**  
**IRQ=3, 4,**  
**5, 6, 7, 10,**  
**11, 12**      Serial Port I/O port address is 2F8h and the interrupt address is IRQ3, 4, 5, 6, 7, 10, 11, 12
- **IO=3E8h;**  
**IRQ=3, 4,**  
**5, 6, 7, 10,**  
**11, 12**      Serial Port I/O port address is 3E8h and the interrupt address is IRQ3, 4, 5, 6, 7, 10, 11, 12
- **IO=2E8h;**  
**IRQ=3, 4,**  
**5, 6, 7, 10,**  
**11, 12**      Serial Port I/O port address is 2E8h and the interrupt address is IRQ3, 4, 5, 6, 7, 10, 11, 12

### 5.3.9.2.2 COM 2 Configuration

#### → **Serial Port [Enabled]**

Use the **Serial Port** option to enable or disable the serial port.

- **Disabled**      Disable the serial port
- **Enabled**      **DEFAULT**      Enable the serial port

#### → **Select Serial or IrDA [Serial Port]**

Use the **Select Serial or IrDA** option to select the serial port mode.

- ➔ **Serial Port**      **DEFAULT**      Enables for serial port function.
- ➔ **IrDA**                                      Enables for IrDA function.

➔ **Change Settings [Auto]**

Use the **Change Settings** option to change the serial port IO port address and interrupt address.

- ➔ **Auto**                      **DEFAULT**      The serial port IO port address and interrupt address are automatically detected.
- ➔ **IO=2F8h;**  
**IRQ=3**                                      Serial Port I/O port address is 2F8h and the interrupt address is IRQ3
- ➔ **IO=3F8h;**  
**IRQ=3, 4,**  
**5, 6, 7, 10,**  
**11, 12**                                      Serial Port I/O port address is 3F8h and the interrupt address is IRQ3, 4, 5, 6, 7, 10, 11, 12
- ➔ **IO=2F8h;**  
**IRQ=3, 4,**  
**5, 6, 7, 10,**  
**11, 12**                                      Serial Port I/O port address is 2F8h and the interrupt address is IRQ3, 4, 5, 6, 7, 10, 11, 12
- ➔ **IO=3E8h;**  
**IRQ=3, 4,**  
**5, 6, 7, 10,**  
**11, 12**                                      Serial Port I/O port address is 3E8h and the interrupt address is IRQ3, 4, 5, 6, 7, 10, 11, 12
- ➔ **IO=2E8h;**  
**IRQ=33, 4,**  
**5, 6, 7, 10,**  
**11, 12**                                      Serial Port I/O port address is 2E8h and the interrupt address is IRQ3, 4, 5, 6, 7, 10, 11, 12



## ICE-CV-D25502/N26002 COM Express Module

### 5.3.9.3 Parallel Port Configuration

Use the **Parallel Port Configuration** menu (**BIOS Menu 15**) to configure the serial port n.

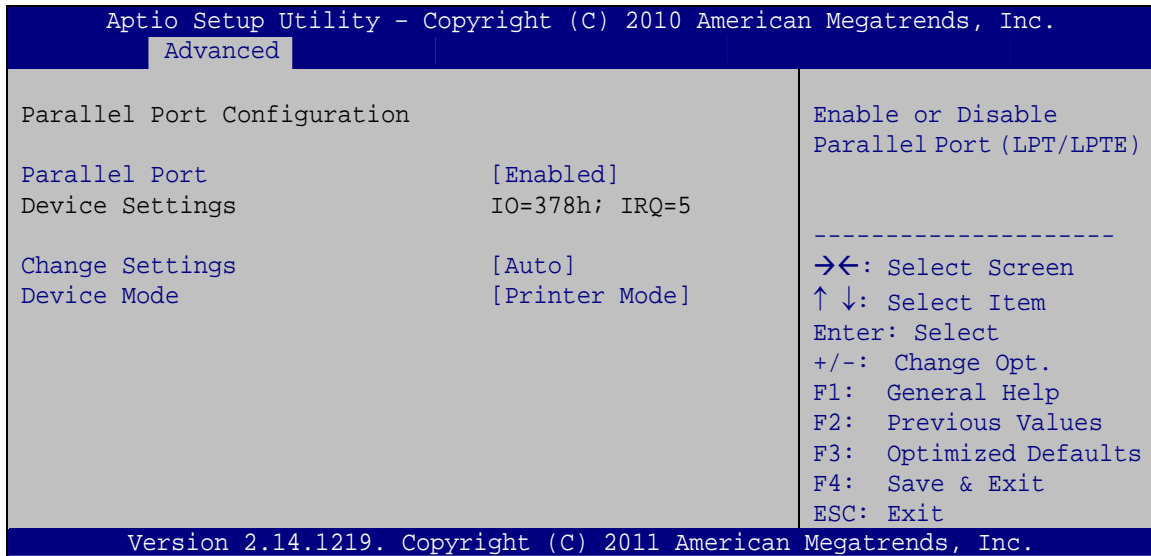

#### BIOS Menu 15: Parallel Port Configuration Menu

##### → Parallel Port [Enabled]

Use the **Parallel Port** option to enable or disable the parallel port.

- **Disabled**                      Disable the parallel port
- **Enabled**            **DEFAULT**      Enable the parallel port

##### → Change Settings [Auto]

Use the **Change Settings** option to change the parallel port IO port address and interrupt address.

- **Auto**            **DEFAULT**      The parallel port IO port address and interrupt address are automatically detected.
- **IO=378h;**  
**IRQ=5**                      Parallel Port I/O port address is 378h and the interrupt address is IRQ5

- IO=378h; Parallel Port I/O port address is 378h and the  
IRQ=5, 6, interrupt address is IRQ5, 6, 7, 10, 11, 12  
7, 10, 11,  
12
- IO=278h; Parallel Port I/O port address is 278h and the  
IRQ=5, 6, interrupt address is IRQ5, 6, 7, 10, 11, 12  
7, 10, 11,  
12
- IO=3BCh; Parallel Port I/O port address is 3BCh and the  
IRQ=5, 6, interrupt address is IRQ5, 6, 7, 10, 11, 12  
7, 10, 11,  
12

→ **Device Mode [Printer Mode]**

Use the **Device Mode** option to select the mode the parallel port operates in. Configuration options are listed below.

- Printer Mode **Default**
- SPP Mode
- EPP-1.9 and SPP Mode
- EPP-1.7 and SPP Mode
- ECP Mode
- ECP and EPP 1.9 Mode
- ECP and EPP 1.7 Mode

**5.3.10 WinBond W83627EHG Hardware Monitor**

The **WinBond W83627EHG Hardware Monitor** menu (**BIOS Menu 16**) displays the operating temperatures, fan speeds and system voltages.

## ICE-CV-D25502/N26002 COM Express Module

```

Aptio Setup Utility - Copyright (C) 2011 American Megatrends, Inc.
Advanced
WinBond W83627EHG Hardware Monitor

SYS Temperature           : +48 C
CPU Temperature           : +48 C
CPU Fan Speed             : N/A
Fan 2 Speed              : N/A
+12V                      : +12.144 V
AVCC                      : +3.296 V
3VCC                     : +3.296 V
+3.3V                    : +3.344 V
VSB                      : +3.296 V
VBAT                     : +3.280 V

-----
-><: Select Screen
↑↓: Select Item
Enter: Select
+/-: Change Opt.
F1: General Help
F2: Previous Values
F3: Optimized Defaults
F4: Save & Exit
ESC: Exit

Version 2.14.1219. Copyright (C) 2011 American Megatrends, Inc.

```

### BIOS Menu 16: WinBond W83627EHG Hardware Monitor

#### → PC Health Status

The following system parameters and values are shown. The system parameters that are monitored are:

- System Temperatures:
  - CPU Temperature
  - SYS Temperature
- Fan Speeds:
  - CPU Fan Speed
  - Fan 2 Speed
- Voltages:
  - +12V
  - AVCC
  - 3VCC
  - +3.3V
  - VSB
  - VBAT

### 5.3.11 Serial Port Console Redirection

The **Serial Port Console Redirection** menu (**BIOS Menu 17**) allows the console redirection options to be configured. Console redirection allows users to maintain a system remotely by re-directing keyboard input and text output through the serial port.

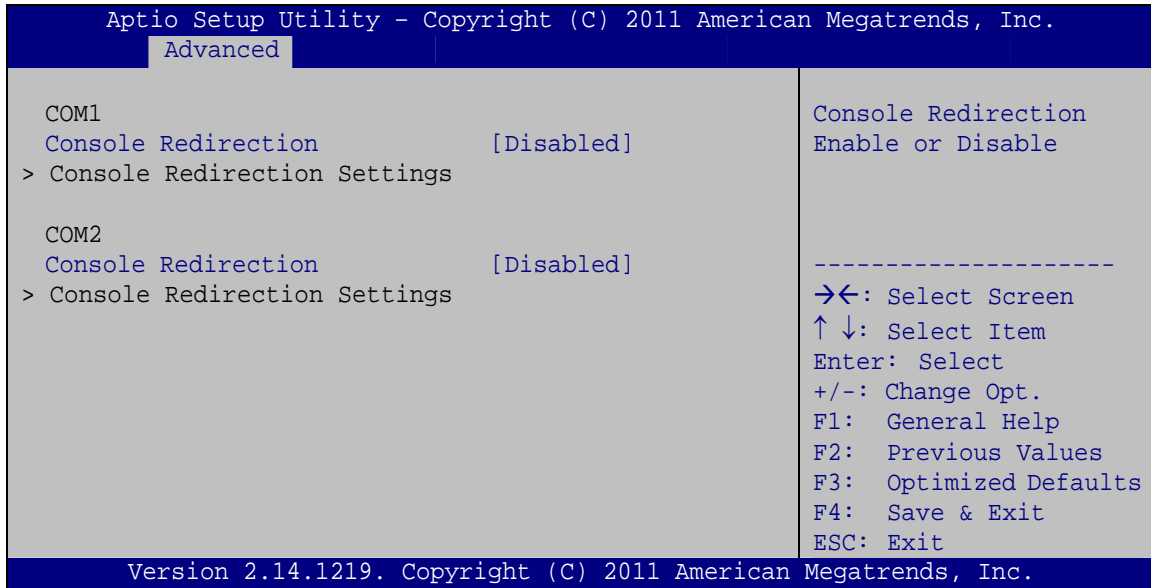

#### BIOS Menu 17: Serial Port Console Redirection

##### → Console Redirection [Disabled]

Use **Console Redirection** option to enable or disable the console redirection function.

- **Disabled**      **DEFAULT**      Disabled the console redirection function
- **Enabled**                      Enabled the console redirection function

##### → Terminal Type [ANSI]

Use the **Terminal Type** option to specify the remote terminal type.

- **VT100**                      The target terminal type is VT100
- **VT100+**                      The target terminal type is VT100+
- **VT-UTF8**                      The target terminal type is VT-UTF8
- **ANSI**                      **DEFAULT**      The target terminal type is ANSI

## ICE-CV-D25502/N26002 COM Express Module

### → Bits per second [115200]

Use the **Bits per second** option to specify the serial port transmission speed. The speed must match the other side. Long or noisy lines may require lower speeds.

- **9600** Sets the serial port transmission speed at 9600.
- **19200** Sets the serial port transmission speed at 19200.
- **38400** Sets the serial port transmission speed at 38400.
- **57600** Sets the serial port transmission speed at 57600.
- **115200** **DEFAULT** Sets the serial port transmission speed at 115200.

### → Data Bits [8]

Use the **Data Bits** option to specify the number of data bits.

- **7** Sets the data bits at 7.
- **8** **DEFAULT** Sets the data bits at 8.

### → Parity [None]

Use the **Parity** option to specify the parity bit that can be sent with the data bits for detecting the transmission errors.

- **None** **DEFAULT** No parity bit is sent with the data bits.
- **Even** The parity bit is 0 if the number of ones in the data bits is even.
- **Odd** The parity bit is 0 if the number of ones in the data bits is odd.
- **Mark** The parity bit is always 1. This option does not provide error detection.
- **Space** The parity bit is always 0. This option does not provide error detection.

**→ Stop Bits [1]**

Use the **Stop Bits** option to specify the number of stop bits used to indicate the end of a serial data packet. Communication with slow devices may require more than 1 stop bit.

- 1            DEFAULT**      Sets the number of stop bits at 1.
- 2**                              Sets the number of stop bits at 2.

**5.3.12 iEi Feature**

Use the **iEi Feature** menu (**BIOS Menu 18**) to configure One Key Recovery function.

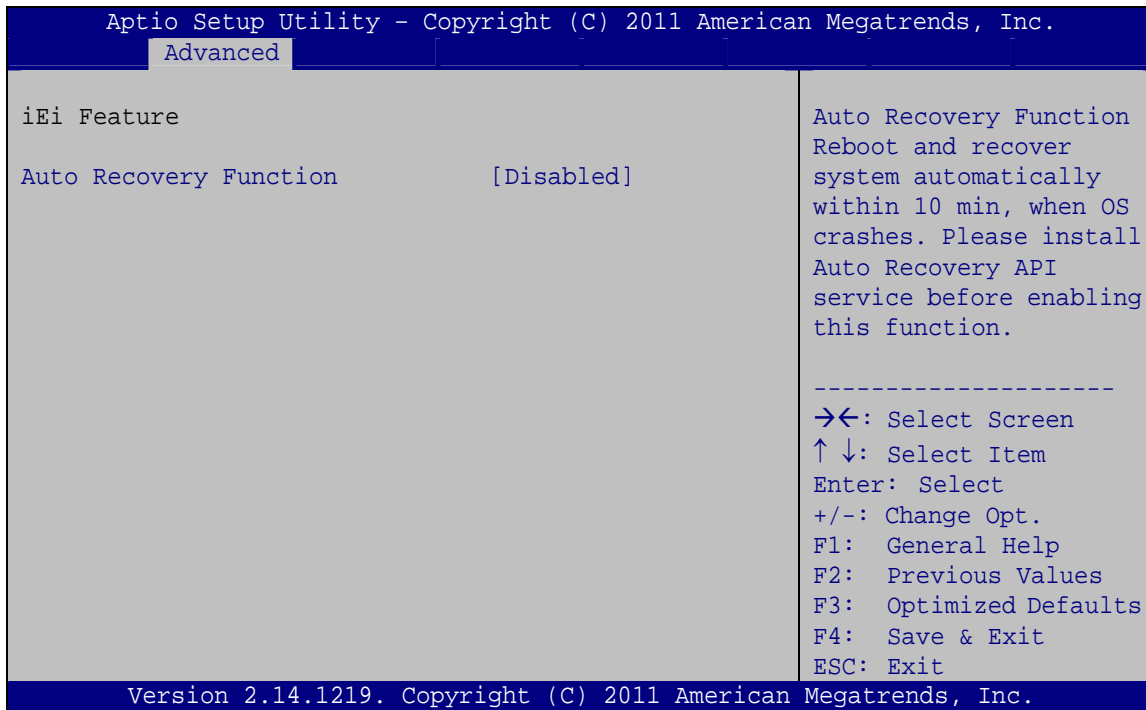
**BIOS Menu 18: iEi Feature**
**→ Auto Recovery Function [Disabled]**

Use the **Auto Recovery Function** BIOS option to enable or disable the auto recovery function of the IEI One Key Recovery.

- Disabled      DEFAULT**      Auto recovery function disabled
- Enabled**                      Auto recovery function enabled

## ICE-CV-D25502/N26002 COM Express Module

### 5.4 Chipset

Use the **Chipset** menu (**BIOS Menu 19**) to access the Host Bridge and Southbridge configuration menus.



#### **WARNING!**

Setting the wrong values for the Chipset BIOS selections in the Chipset BIOS menu may cause the system to malfunction.

```

Aptio Setup Utility - Copyright (C) 2011 American Megatrends, Inc.
Main   Advanced  Chipset  Boot   Security  Save & Exit
-----
> Host Bridge
> South Bridge

Host Bridge Parameters
-----
-><: Select Screen
↑↓: Select Item
Enter: Select
+/-: Change Opt.
F1: General Help
F2: Previous Values
F3: Optimized Defaults
F4: Save & Exit
ESC: Exit

Version 2.14.1219. Copyright (C) 2011 American Megatrends, Inc.
  
```

#### **BIOS Menu 19: Chipset**

#### 5.4.1 Host Bridge Configuration

Use the **Host Bridge Configuration** menu (**BIOS Menu 20**) to configure the Intel IGD Configuration and display the memory information.

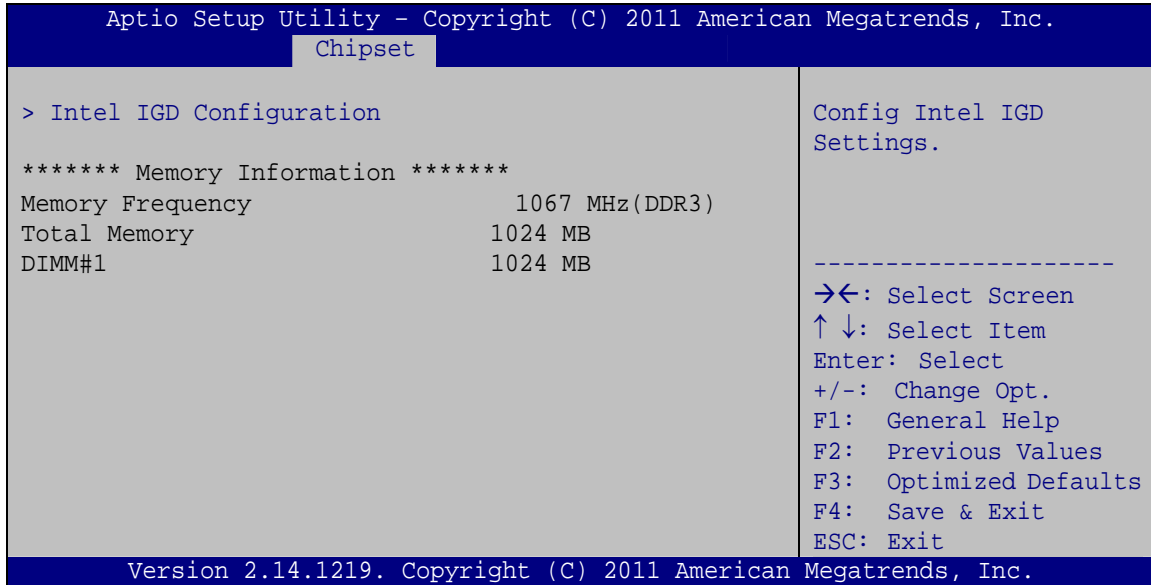
**BIOS Menu 20: Host Bridge Configuration**
**5.4.1.1 Intel IGD Configuration**

Use the **Intel IGD Configuration** submenu (**BIOS Menu 21**) to configure the video device connected to the system.

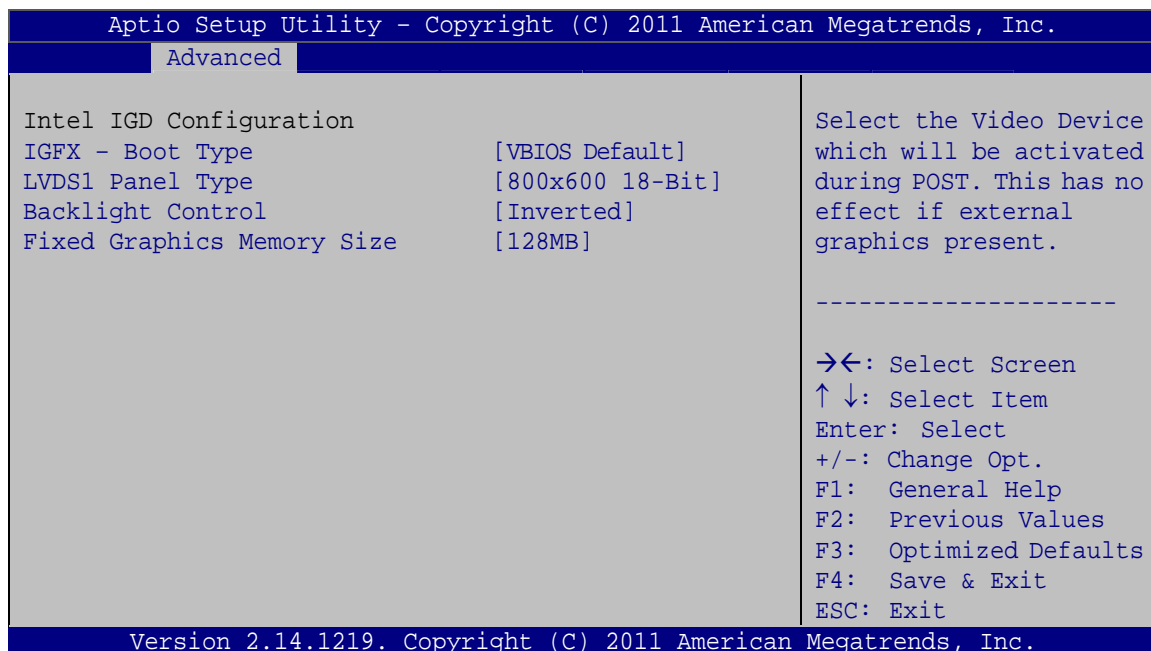
**BIOS Menu 21: Intel IGD Configuration**



## ICE-CV-D25502/N26002 COM Express Module

### → IGFX - Boot Type [VBIOS Default]

Use the **IGFX - Boot Type** option to select the display device used by the system when it boots. Configuration options are listed below.

- VBIOS Default    **DEFAULT**
- CRT
- Display Port 1
- Display Port 2
- LVDS1
- CRT + LVDS1

### → LVDS1 Panel Type [800x600 18-Bit]

Use the **LVDS1 Panel Type** option to select the type of flat panel connected to the LVDS connector. Configuration options are listed below.

- 640x480 18-Bit
- 800x600 18-Bit    **DEFAULT**
- 1024x768 18-Bit
- 1280x1024 24-Bit
- 1366x768 18-Bit
- 1024x600 18-Bit
- 1280x800 18-Bit
- 1024x768 24-Bit
- 1366x768 24-Bit

### → Backlight Control [Inverted]

Use the **Backlight Control** option to select the backlight control mode.

- **Normal**                      Brightest at high voltage level
- **Inverted**    **DEFAULT**      Brightest at low voltage level

### → Fixed Graphics Memory Size [128MB]

Use the **Fixed Graphics Memory Size** option to specify the maximum amount of memory that can be allocated as graphics memory. Configuration options are listed below.

- 128MB      **DEFAULT**
- 256MB

### 5.4.2 South Bridge Configuration

Use the **South Bridge Configuration** menu (**BIOS Menu 22**) to configure the Southbridge chipset.

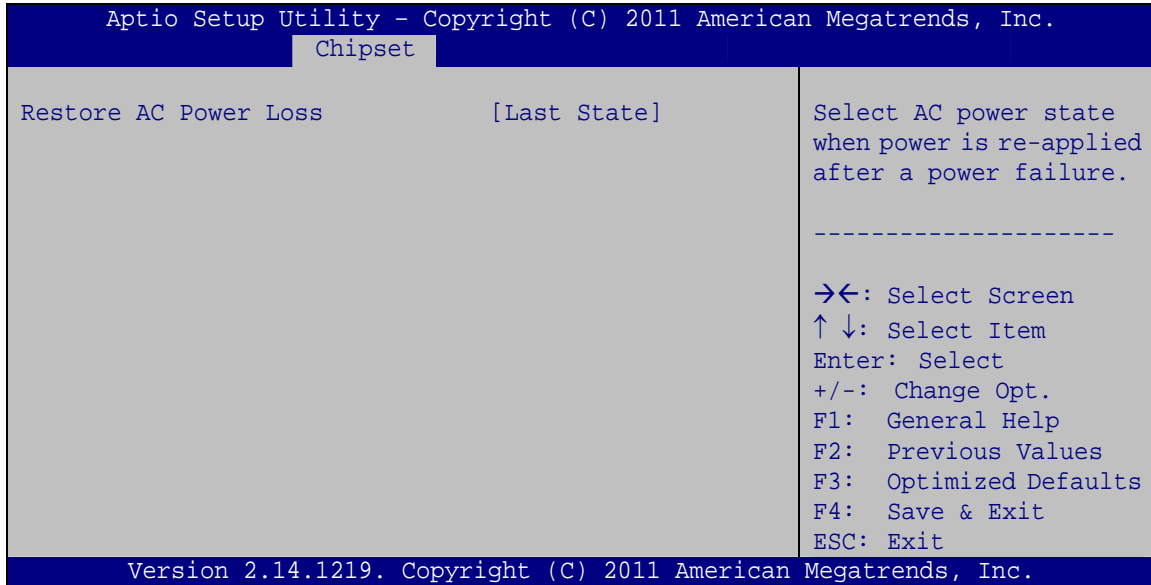

#### **BIOS Menu 22: Southbridge Configuration**

##### → **Restore AC Power Loss [Last State]**

Use the **Restore AC Power Loss** BIOS option to specify what state the system returns to if there is a sudden loss of power to the system.

- **Power Off**      The system remains turned off
- **Power On**      The system turns on
- **Last State      DEFAULT**      The system returns to its previous state. If it was on, it turns itself on. If it was off, it remains off.

## 5.5 Boot

Use the **Boot menu (BIOS Menu 23)** to configure system boot options.

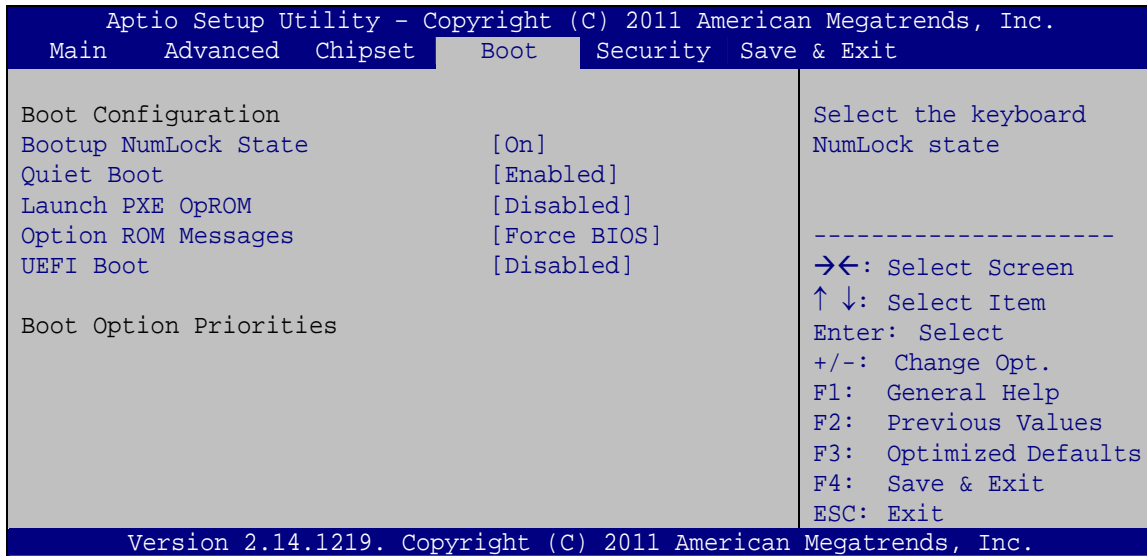

### BIOS Menu 23: Boot

#### → Bootup NumLock State [On]

Use the **Bootup NumLock State** BIOS option to specify if the number lock setting must be modified during boot up.

→ **On**                      **DEFAULT**                      Allows the Number Lock on the keyboard to be enabled automatically when the computer system boots up. This allows the immediate use of the 10-key numeric keypad located on the right side of the keyboard. To confirm this, the Number Lock LED light on the keyboard is lit.

→ **Off**                                      Does not enable the keyboard Number Lock automatically. To use the 10-keys on the keyboard, press the Number Lock key located on the upper left-hand corner of the 10-key pad. The Number Lock LED on the keyboard lights up when the Number Lock is engaged.

**→ Quiet Boot [Enabled]**

Use the **Quiet Boot** BIOS option to select the screen display when the system boots.

- **Disabled** Normal POST messages displayed
- **Enabled** **DEFAULT** OEM Logo displayed instead of POST messages

**→ Launch PXE OpROM [Disabled]**

Use the **Launch PXE OpROM** option to enable or disable boot option for legacy network devices.

- **Disabled** **DEFAULT** Ignore all PXE Option ROMs
- **Enabled** Load PXE Option ROMs.

**→ Option ROM Messages [Force BIOS]**

Use the **Option ROM Messages** option to set the Option ROM display mode.

- **Force BIOS** **DEFAULT** Sets display mode to force BIOS.
- **Keep Current** Sets display mode to current.

**→ UEFI Boot [Disabled]**

Use the **UEFI Boot** BIOS option to allow the system to boot from the UEFI devices.

- **Disabled** **DEFAULT** Disables to boot from the UEFI devices.
- **Enabled** Enables to boot from the UEFI devices.

## 5.6 Security

Use the **Security** menu (**BIOS Menu 24**) to set system and user passwords.

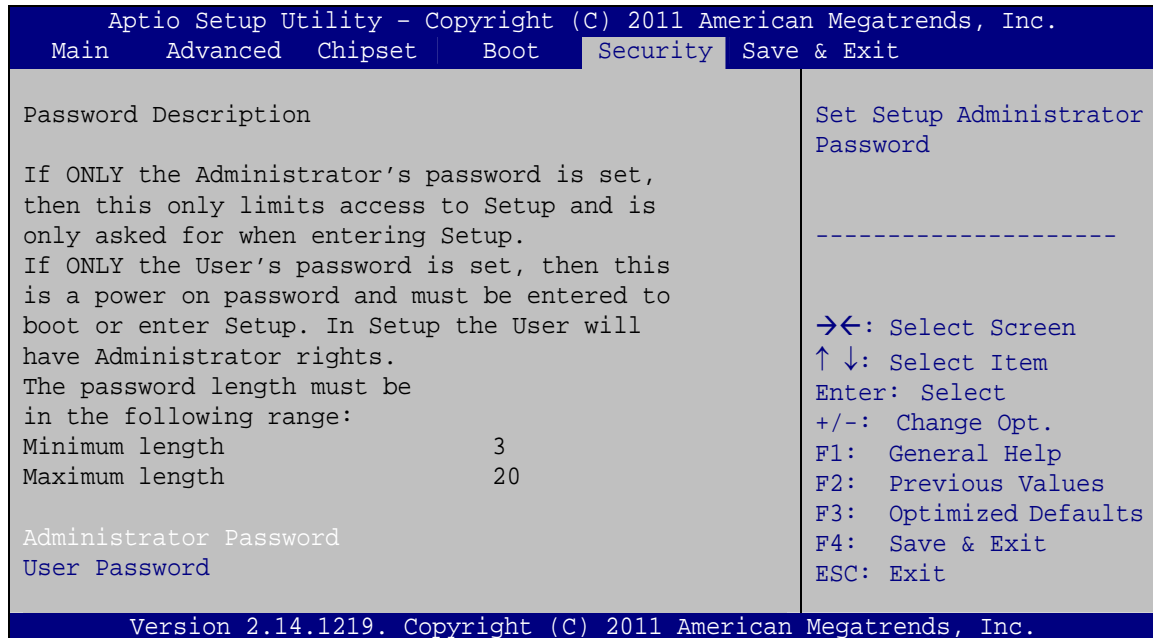

### BIOS Menu 24: Security

#### → Administrator Password

Use the **Administrator Password** to set or change an administrator password.

#### → User Password

Use the **User Password** to set or change a user password.

## 5.7 Save & Exit

Use the **Save & Exit** menu (**BIOS Menu 25**) to load default BIOS values, optimal failsafe values and to save configuration changes.

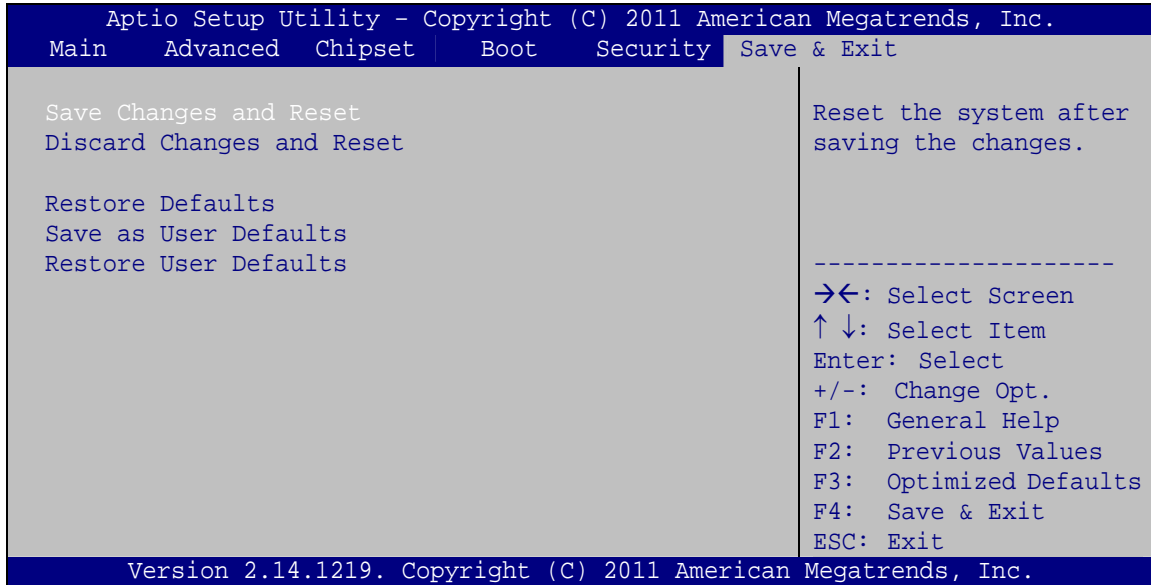

### BIOS Menu 25: Save & Exit

#### → Save Changes and Reset

Use the **Save Changes and Reset** option to save the changes made to the BIOS options and reset the system.

#### → Discard Changes and Reset

Use the **Discard Changes and Reset** option to exit the system without saving the changes made to the BIOS configuration setup program.

#### → Restore Defaults

Use the **Restore Defaults** option to load the optimal default values for each of the parameters on the Setup menus. **F3 key can be used for this operation.**

#### → Save as User Defaults

Use the **Save as User Defaults** option to save the changes done so far as user defaults.

#### → Restore User Defaults

Use the **Restore User Defaults** option to restore the user defaults to all the setup options.

Chapter

6

# Software Drivers

---

## 6.1 Available Software Drivers

---



### NOTE:

The content of the CD may vary throughout the life cycle of the product and is subject to change without prior notice. Visit the IEI website or contact technical support for the latest updates.

---

The following drivers can be installed on the system:

- Chipset
- VGA
- LAN
- Audio

Installation instructions are given below.

## 6.2 Starting the Driver Program

To access the driver installation programs, please do the following.

**Step 1:** Insert the CD that came with the system into a CD drive connected to the system.

---



### NOTE:

If the installation program doesn't start automatically:  
Click "Start->Computer->CD Drive->autorun.exe"

---

**Step 2:** The driver main menu appears (**Figure 6-1**).



# ICE-CV-D25502/N26002 COM Express Module

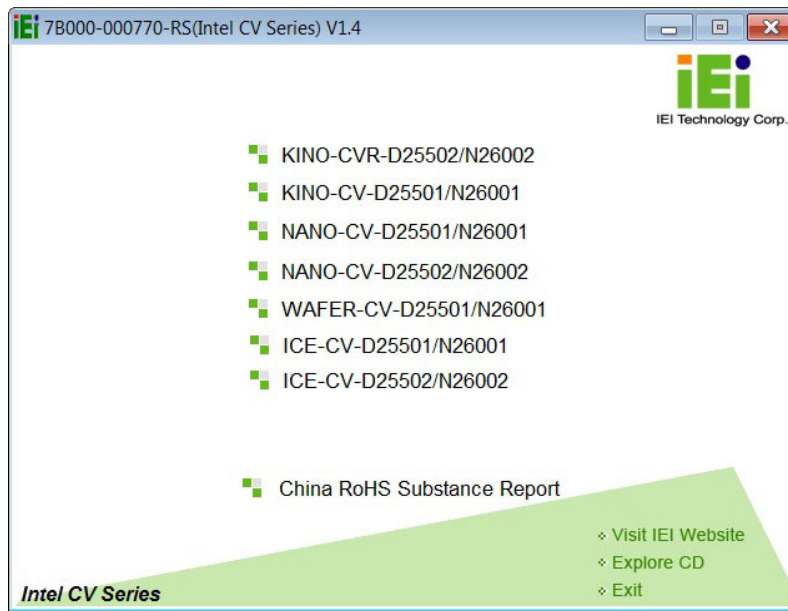

**Figure 6-1: Start Up Screen**

**Step 3:** Click ICE-CV-D25502/N26002.

**Step 4:** The list of drivers in **Figure 6-2** appears.

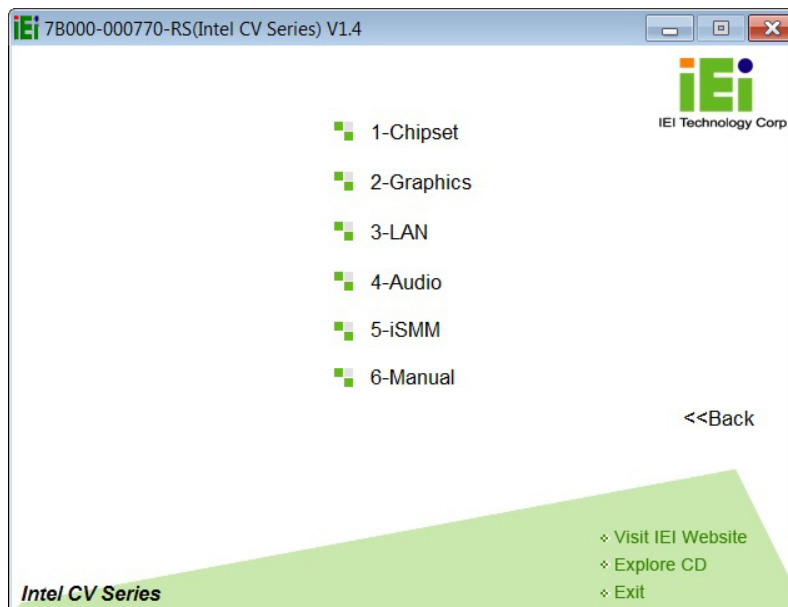
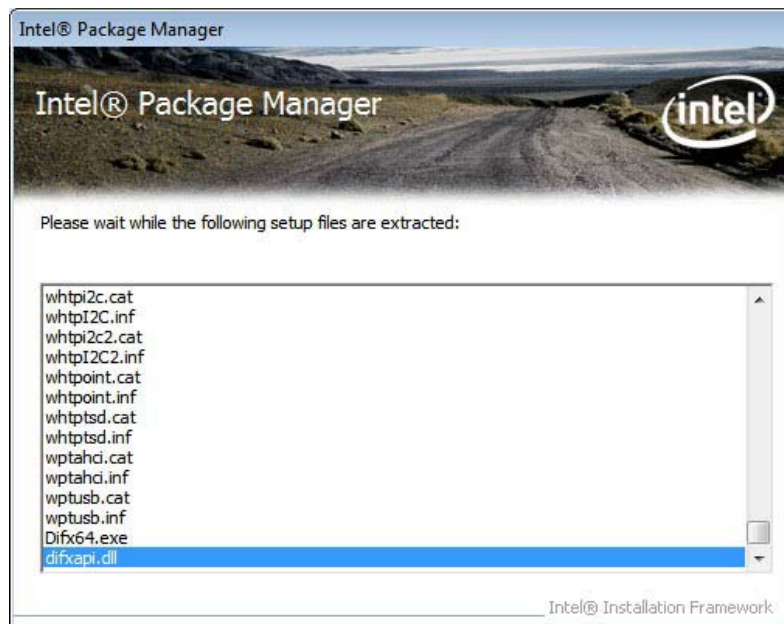

**Figure 6-2: Drivers**

### 6.3 Chipset Driver Installation

To install the chipset driver, please do the following.

- Step 1:** Access the driver list. (See **Section 6.2**)
- Step 2:** Click “**1-Chipset**”.
- Step 3:** Go to the 32-bit or 64-bit folder that corresponds to your OS version.
- Step 4:** Open the **Intel Chipset Software Installation Utility** folder.
- Step 5:** Double click the **infinst\_autol** icon.
- Step 6:** The setup files are extracted as shown in **Figure 6-3**.



**Figure 6-3: Chipset Driver Screen**

- Step 7:** When the setup files are completely extracted, the **Welcome Screen** in **Figure 6-4** appears.



**Figure 6-4: Chipset Driver Welcome Screen**

**Step 8:** Click **Next** to continue.

**Step 9:** The license agreement in **Figure 6-5** appears.

**Step 10:** Read the **License Agreement**.

**Step 11:** Click **Yes** to continue.



**Figure 6-5: Chipset Driver License Agreement**

**Step 12:** The Read Me file in **Figure 6-6** appears.

**Step 13:** Click **Next** to continue.



**Figure 6-6: Chipset Driver Read Me File**

**Step 14:** Setup Operations are performed as shown in **Figure 6-7**.

## ICE-CV-D25502/N26002 COM Express Module

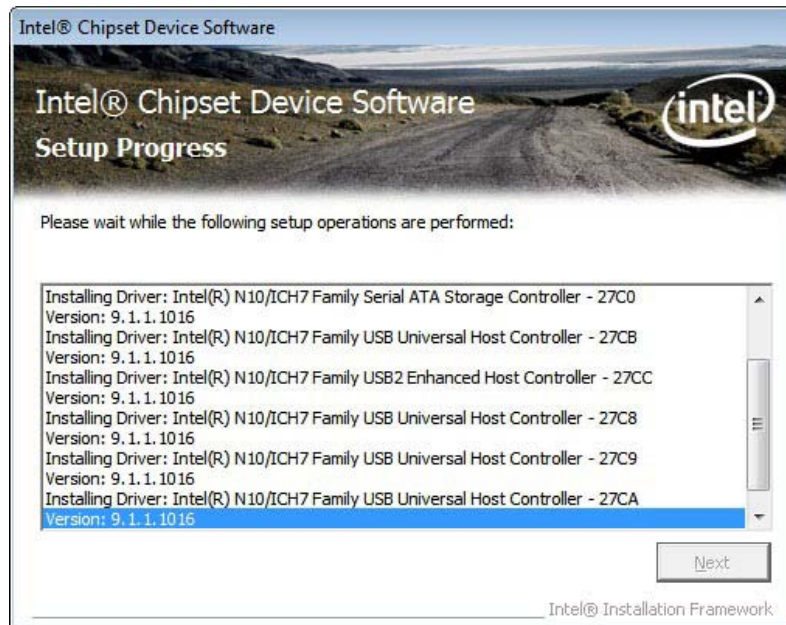

Figure 6-7: Chipset Driver Setup Operations

**Step 15:** Once the **Setup Operations** are complete, click **Next** to continue.

**Step 16:** The **Finish** screen appears.

**Step 17:** Select “**Yes, I want to restart the computer now**” and click the **Finish** icon.

See **Figure 6-8**.



Figure 6-8: Chipset Driver Installation Finish Screen

## 6.4 VGA Driver Installation



### NOTE:

Due to Intel® GMA driver limitation, the monitor connected to the VGA connector may become extended desktop or not have signal to it after restarting from the graphics driver installation. To work out this limitation, press the Ctrl+Alt+F1 hotkey to switch the primary display to CRT mode.

To install the VGA driver, please do the following.

- Step 1:** Access the driver list. (See **Section 6.2**)
- Step 2:** Click “**2-Graphics**”.
- Step 3:** Open the 32-bit or 64-bit folder that corresponds to your OS version.
- Step 4:** Double click the **Setup** icon.

## ICE-CV-D25502/N26002 COM Express Module

**Step 5:** The **Welcome Screen** in **Figure 6-9** appears.



**Figure 6-9: VGA Driver Welcome Screen**

**Step 6:** Click **Next** to continue.

**Step 7:** The license agreement in **Figure 6-10** appears.

**Step 8:** Read the **License Agreement**.

**Step 9:** Click **Yes** to continue.



Figure 6-10: VGA Driver License Agreement

**Step 10:** The Read Me file in Figure 6-11 appears.

**Step 11:** Click **Next** to continue.

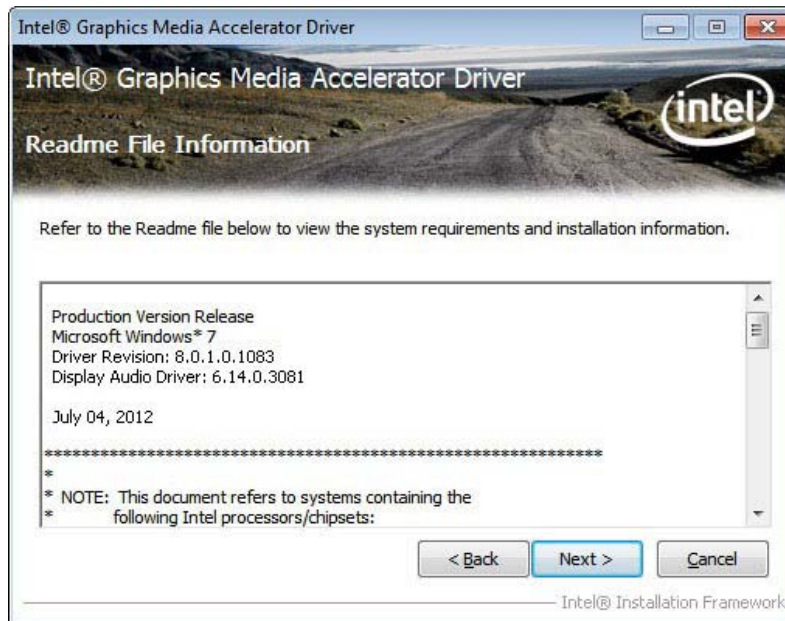
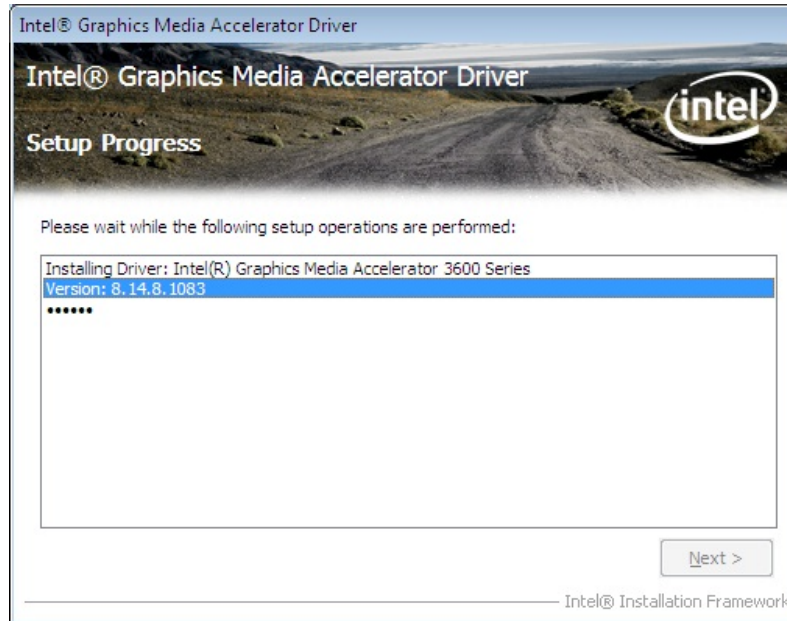

Figure 6-11: VGA Driver Read Me File

**Step 12:** Setup Operations are performed as shown in Figure 6-12.



## ICE-CV-D25502/N26002 COM Express Module



**Figure 6-12: VGA Driver Setup Operations**

**Step 13:** Once the **Setup Operations** are complete, click the **Next** icon to continue.

**Step 14:** The **Finish** screen appears.

**Step 15:** Select “**Yes, I want to restart the computer now**” and click the **Finish** icon.

See **Figure 6-13**.



**Figure 6-13: VGA Driver Installation Finish Screen**

## 6.5 LAN Driver Installation

To install the LAN driver, please do the following.

**Step 1:** Access the driver list shown in Figure 6-2. (See **Section 6.2**)

**Step 2:** Click “3-LAN”.

**Step 3:** Go to the **Realtek > Install\_Win7\_7048\_09162011** folder.

**Step 4:** Double click the **setup** icon.

**Step 5:** The **Welcome** screen in **Figure 6-14** appears.

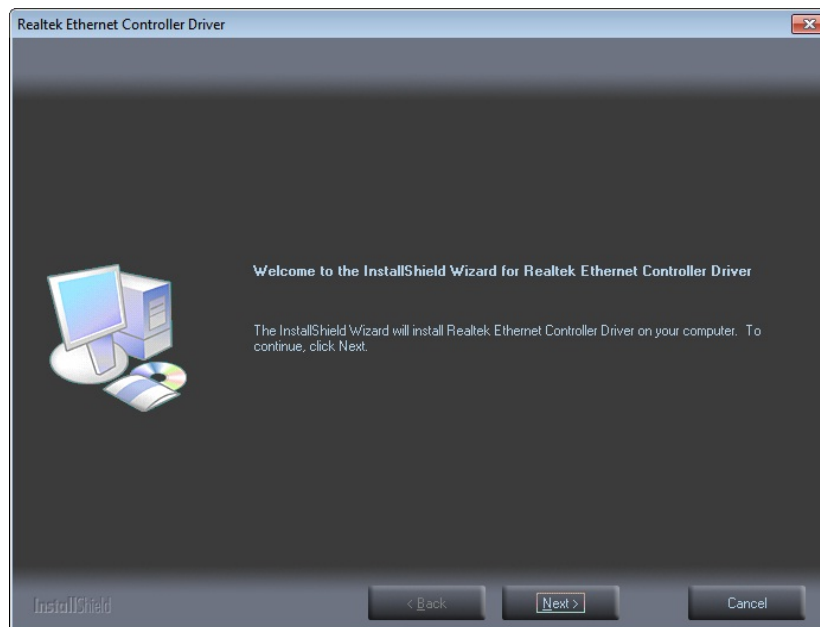

**Figure 6-14: LAN Driver Welcome Screen**

**Step 6:** Click **Next** to continue.

**Step 7:** The **Ready to Install** screen in **Figure 6-15** appears.

**Step 8:** Click **Install** to proceed with the installation.

# ICE-CV-D25502/N26002 COM Express Module

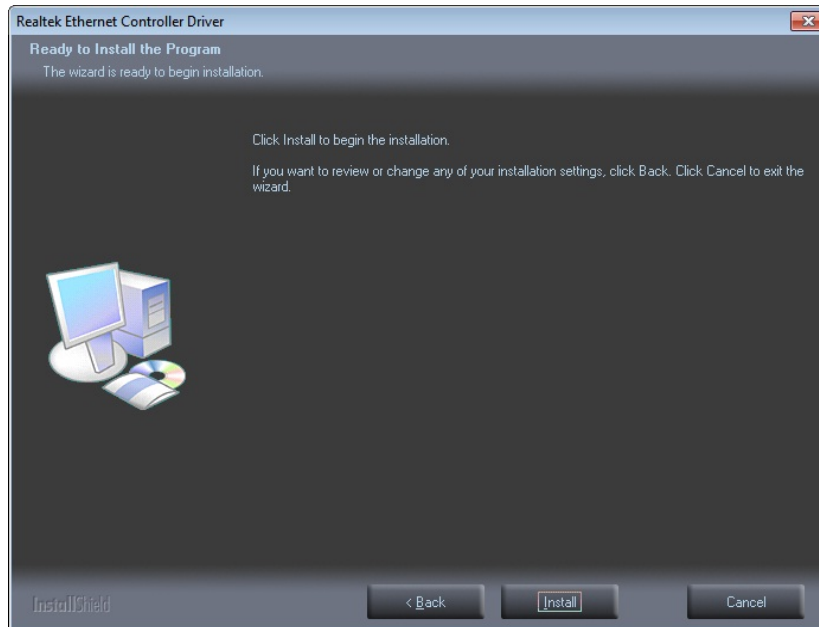
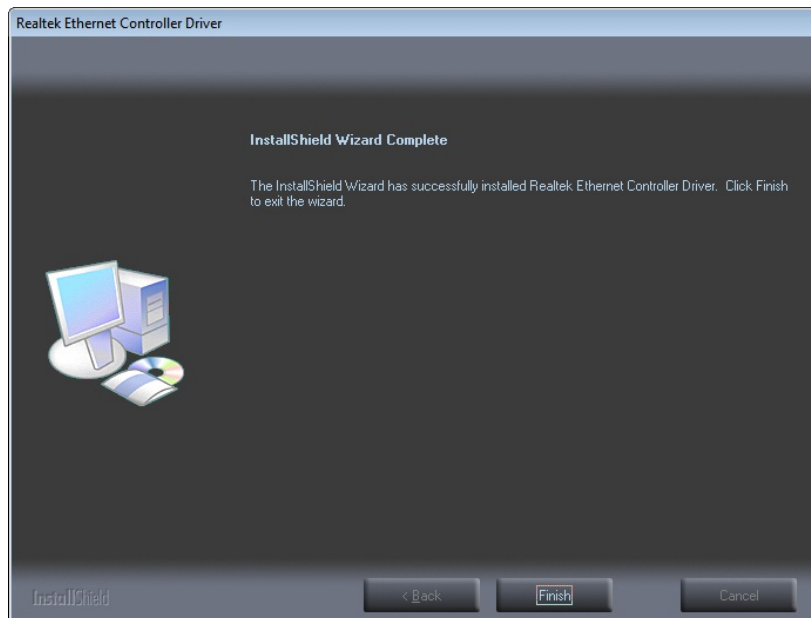

**Figure 6-15: LAN Driver Installation**

**Step 9:** The program begins to install.

**Step 10:** When the driver installation is complete, the screen in **Figure 6-16** appears.

**Step 11:** Click **Finish** to exit.



**Figure 6-16: LAN Driver Installation Complete**

## 6.6 Audio Driver Installation

To install the Audio driver, please do the following.

**Step 1:** Access the driver list. (See **Section 6.2**)

**Step 2:** Click “4-Audio”.

**Step 3:** Open the **Win7** folder.

**Step 4:** Double click the **Vista\_Win7\_R263** icon.

**Step 5:** The installation files are extracted as shown in **Figure 6-17**.

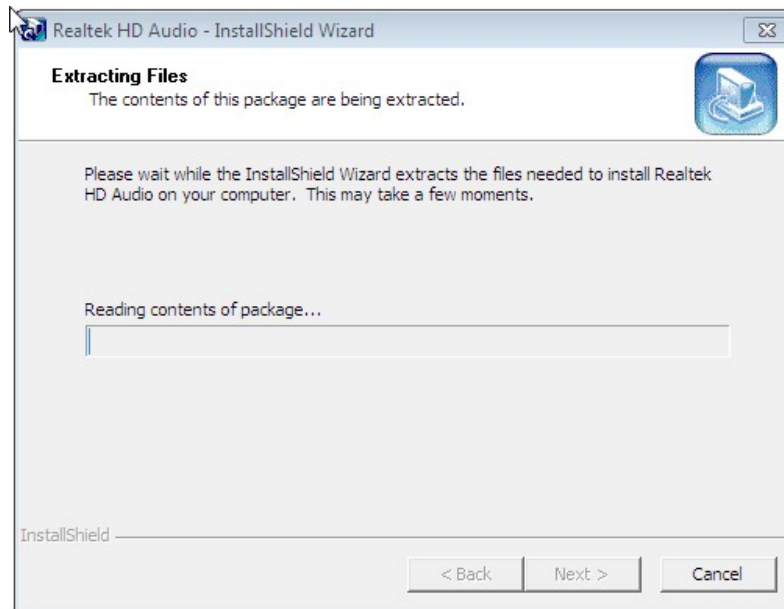

**Figure 6-17: Audio Driver Installation File Extraction**

**Step 6:** The **Welcome** screen in **Figure 6-18** appears.

# ICE-CV-D25502/N26002 COM Express Module

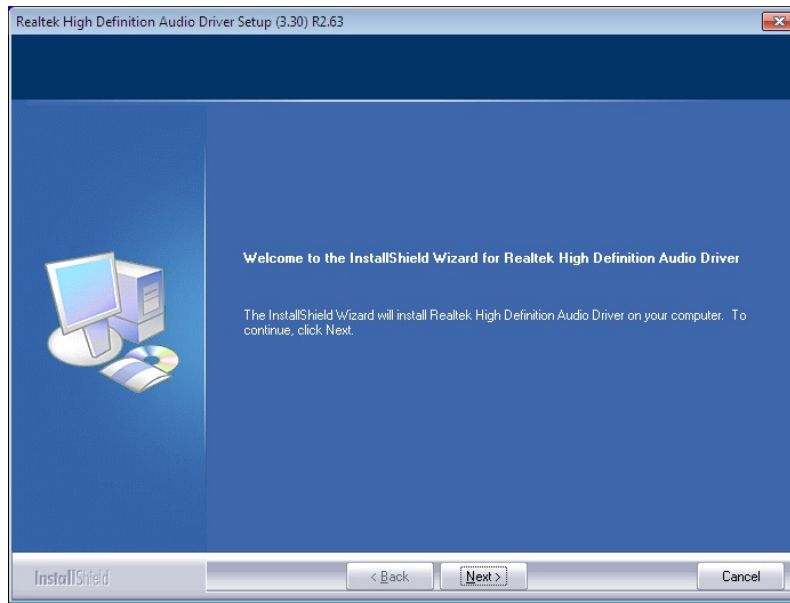
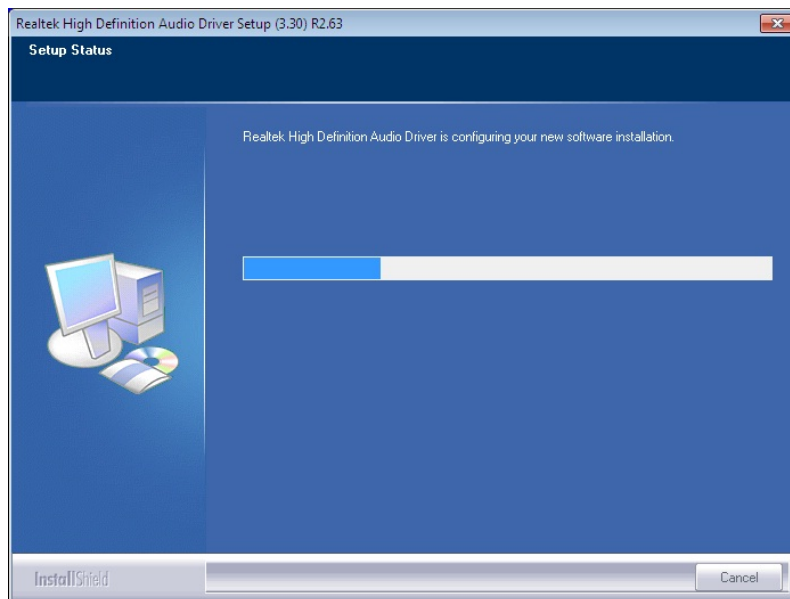

**Figure 6-18: Audio Driver Welcome Screen**

**Step 7:** Click **Next** to continue.

**Step 8:** The program begins to install.

**Step 9:** The installation progress can be monitored in the progress bar shown in **Figure 6-19**.



**Figure 6-19: Audio Driver Installation**

**Step 10:** When the driver installation is complete, the screen in **Figure 6-20** appears.

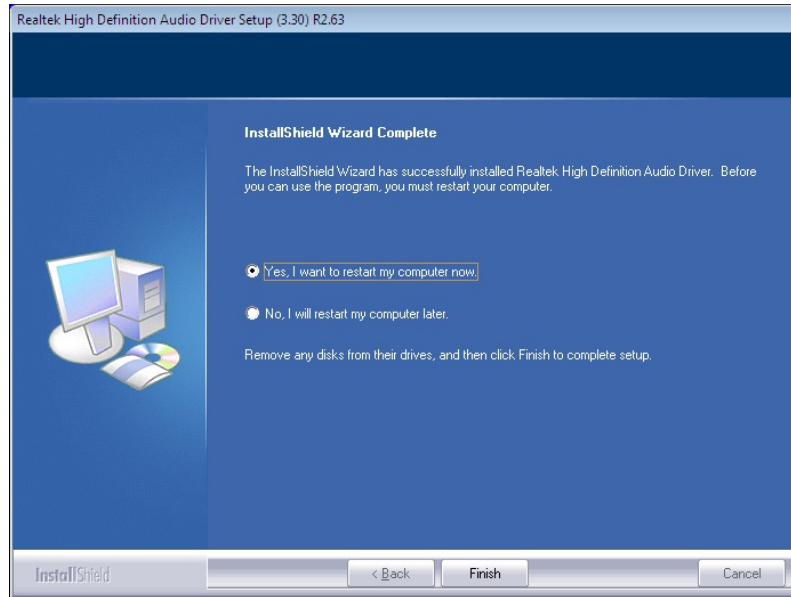

**Figure 6-20: Audio Driver Installation Complete**

**Step 11:** Select “Yes, I want to restart my computer now” and click **Finish**.

**Step 12:** The system reboots.

Appendix

A

# BIOS Options

---

Below is a list of BIOS configuration options in the BIOS chapter.

<b>System Overview</b> .....	<b>35</b>
<b>System Date [xx/xx/xx]</b> .....	<b>35</b>
<b>System Time [xx:xx:xx]</b> .....	<b>36</b>
<b>ACPI Sleep State [S1 (CPU Stop Clock)]</b> .....	<b>37</b>
<b>Wake system with Fixed Time [Disabled]</b> .....	<b>38</b>
<b>Security Device Support [Disable]</b> .....	<b>39</b>
<b>Hyper-Threading [Enabled]</b> .....	<b>41</b>
<b>Configure SATA as [IDE]</b> .....	<b>41</b>
<b>USB Devices</b> .....	<b>42</b>
<b>Legacy USB Support [Enabled]</b> .....	<b>42</b>
<b>CPU Fan Speed Value</b> .....	<b>43</b>
<b>Serial Port [Enabled]</b> .....	<b>45</b>
<b>Change Settings [Auto]</b> .....	<b>45</b>
<b>Serial Port [Enabled]</b> .....	<b>45</b>
<b>Change Settings [Auto]</b> .....	<b>46</b>
<b>Serial Port [Enabled]</b> .....	<b>46</b>
<b>Change Settings [Auto]</b> .....	<b>46</b>
<b>Serial Port [Enabled]</b> .....	<b>47</b>
<b>Change Settings [Auto]</b> .....	<b>47</b>
<b>Select RS232/422/485 [RS232]</b> .....	<b>48</b>
<b>Floppy Disk Controller [Enabled]</b> .....	<b>49</b>
<b>Change Settings [Auto]</b> .....	<b>49</b>
<b>Device Mode [Read Write]</b> .....	<b>50</b>
<b>Serial Port [Enabled]</b> .....	<b>50</b>
<b>Change Settings [Auto]</b> .....	<b>50</b>
<b>Serial Port [Enabled]</b> .....	<b>51</b>
<b>Select Serial or IrDA [Serial Port]</b> .....	<b>51</b>
<b>Change Settings [Auto]</b> .....	<b>52</b>
<b>Parallel Port [Enabled]</b> .....	<b>53</b>
<b>Change Settings [Auto]</b> .....	<b>53</b>
<b>Device Mode [Printer Mode]</b> .....	<b>54</b>
<b>PC Health Status</b> .....	<b>55</b>
<b>Console Redirection [Disabled]</b> .....	<b>56</b>



## ICE-CV-D25502/N26002 COM Express Module

Terminal Type [ANSI].....	56
Bits per second [115200].....	57
Data Bits [8] .....	57
Parity [None].....	57
Stop Bits [1].....	58
Auto Recovery Function [Disabled].....	58
IGFX - Boot Type [VBIOS Default].....	61
LVDS1 Panel Type [800x600 18-Bit].....	61
Backlight Control [Inverted].....	61
Fixed Graphics Memory Size [128MB].....	61
Restore AC Power Loss [Last State] .....	62
Bootup NumLock State [On].....	63
Quiet Boot [Enabled] .....	64
Launch PXE OpROM [Disabled].....	64
Option ROM Messages [Force BIOS].....	64
UEFI Boot [Disabled] .....	64
Administrator Password .....	65
User Password .....	65
Save Changes and Reset .....	66
Discard Changes and Reset .....	66
Restore Defaults .....	66
Save as User Defaults .....	66
Restore User Defaults .....	66

Appendix

**B**

# One Key Recovery

---

## B.1 One Key Recovery Introduction

The IEI one key recovery is an easy-to-use front end for the Norton Ghost system backup and recovery tool. This tool provides quick and easy shortcuts for creating a backup and reverting to that backup or reverting to the factory default settings.



### NOTE:

The latest One Key Recovery software provides an auto recovery function that allows a system running Microsoft Windows OS to automatically restore from the factory default image after encountering a Blue Screen of Death (BSoD) or a hang for around 10 minutes. Please refer to Section B.3 for the detailed setup procedure.

---

The IEI One Key Recovery tool menu is shown below.

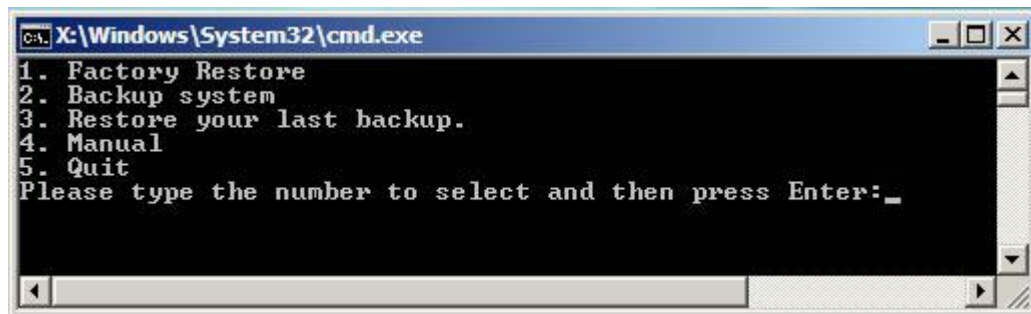

Figure B-1: IEI One Key Recovery Tool Menu

Prior to using the IEI One Key Recovery tool (as shown in **Figure B-1**) to backup or restore Windows system, five setup procedures are required.

1. Hardware and BIOS setup (see Section **B.2.1**)
2. Create partitions (see **Section B.2.2**)
3. Install operating system, drivers and system applications (see **Section B.2.3**)
4. Build-up recovery partition (see **Section B.2.4**)
5. Create factory default image (see **Section B.2.5**)

After completing the five initial setup procedures as described above, users can access the recovery tool by pressing <F3> while booting up the system. The detailed information of each function is described in **Section B.5**.

**NOTE:**

The initial setup procedures for Linux system are described in **Section B.3**.

### B.1.1 System Requirement

**NOTE:**

The recovery CD can only be used with IEI products. The software will fail to run and a warning message will appear when used on non-IEI hardware.

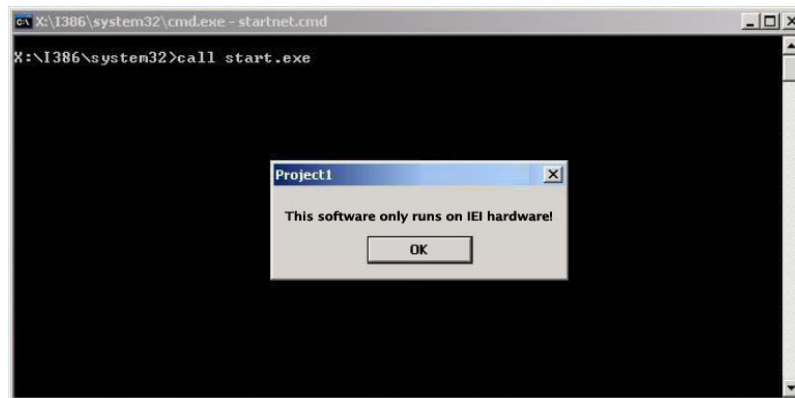

To create the system backup, the main storage device must be split into two partitions (three partitions for Linux). The first partition will be for the operating system, while the second partition will be invisible to the operating system and contain the backup made by the one key recovery software.

The partition created for recovery images must be big enough to contain both the factory default image and the user backup image. The size must be calculated before creating the

## ICE-CV-D25502/N26002 COM Express Module

partitions. Please take the following table as a reference when calculating the size of the partition.

	OS	OS Image after Ghost	Compression Ratio
<b>Windows® 7</b>	7 GB	5 GB	70%
<b>Windows® XPE</b>	776 MB	560 MB	70%
<b>Windows® CE 6.0</b>	36 MB	28 MB	77%



### NOTE:

Specialized tools are required to change the partition size if the operating system is already installed.

### B.1.2 Supported Operating System

The recovery CD is compatible with both Microsoft Windows and Linux operating system (OS). The supported OS versions are listed below.

- Microsoft Windows
  - Windows 2000
  - Windows XP (Service Pack 2 or 3 required)
  - Windows Vista
  - Windows 7
  - Windows CE 5.0
  - Windows CE 6.0
  - Windows XP Embedded
  - Windows Embedded Standard 7



### NOTE:

The auto recovery function (described in **Section B.3**) and the restore through LAN function (described in **Section B.6**) are not supported in the Windows CE 5.0/6.0 operating system environment.

- Linux
  - Fedora Core 12 (Constantine)
  - Fedora Core 11 (Leonidas)
  - Fedora Core 10 (Cambridge)
  - Fedora Core 8 (Werewolf)
  - Fedora Core 7 (Moonshine)
  - RedHat RHEL-5.4
  - RedHat 9 (Ghirke)
  - Ubuntu 8.10 (Intrepid)
  - Ubuntu 7.10 (Gutsy)
  - Ubuntu 6.10 (Edgy)
  - Debian 5.0 (Lenny)
  - Debian 4.0 (Etch)
  - SuSe 11.2
  - SuSe 10.3

**NOTE:**

Installing unsupported OS versions may cause the recovery tool to fail.

---

## B.2 Setup Procedure for Windows

Prior to using the recovery tool to backup or restore, a few setup procedures are required.

**Step 1:** Hardware and BIOS setup (see **Section B.2.1**)

**Step 2:** Create partitions (see **Section B.2.2**)

**Step 3:** Install operating system, drivers and system applications (see **Section B.2.3**)

**Step 4:** Build the recovery partition (see **Section B.2.4**) or build the auto recovery partition (see **Section B.3**)

**Step 5:** Create factory default image (see **Section B.2.5**)

## ICE-CV-D25502/N26002 COM Express Module

The detailed descriptions are described in the following sections.



### NOTE:

The setup procedures described below are for Microsoft Windows operating system users. For Linux, most of the setup procedures are the same except for several steps described in **Section B.3**.

### B.2.1 Hardware and BIOS Setup

- Step 1:** Make sure the system is powered off and unplugged.
- Step 2:** Install a hard drive or SSD in the system. An unformatted and unpartitioned disk is recommended.
- Step 3:** Connect an optical disk drive to the system and insert the recovery CD.
- Step 4:** Turn on the system.
- Step 5:** Press the <DELETE> key as soon as the system is turned on to enter the BIOS.
- Step 6:** Select the connected optical disk drive as the 1<sup>st</sup> boot device. (**Boot** → **Boot Device Priority** → **1<sup>st</sup> Boot Device**).
- Step 7:** Save changes and restart the computer. Continue to the next section for instructions on partitioning the internal storage.

### B.2.2 Create Partitions

To create the system backup, the main storage device must be split into two partitions (three partitions for Linux). The first partition will be for the operating system, while the second partition will be invisible to the operating system and contain the backup made by the one key recovery software.

- Step 1:** Put the recovery CD in the optical drive of the system.

**Step 2:** Boot the system from recovery CD. When prompted, press any key to boot from the recovery CD. It will take a while to launch the recovery tool. Please be patient!

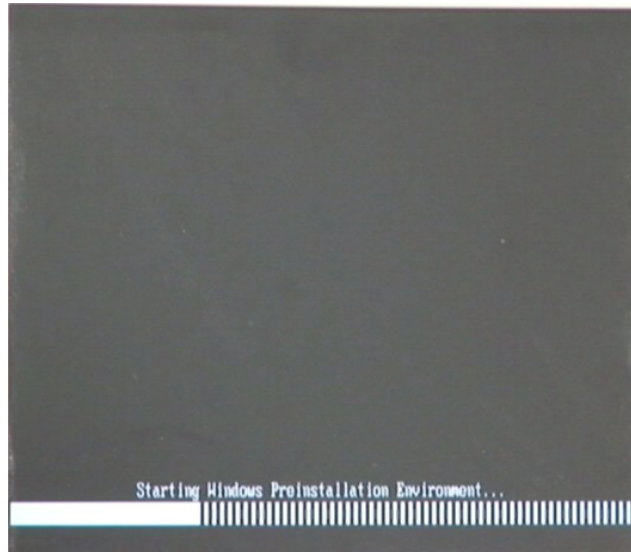

Figure B-2: Launching the Recovery Tool

**Step 3:** The recovery tool setup menu is shown as below.

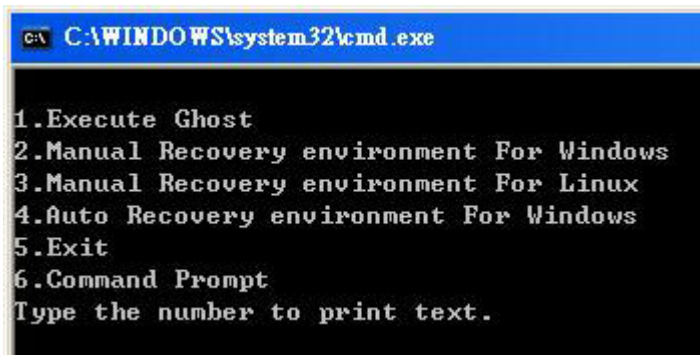
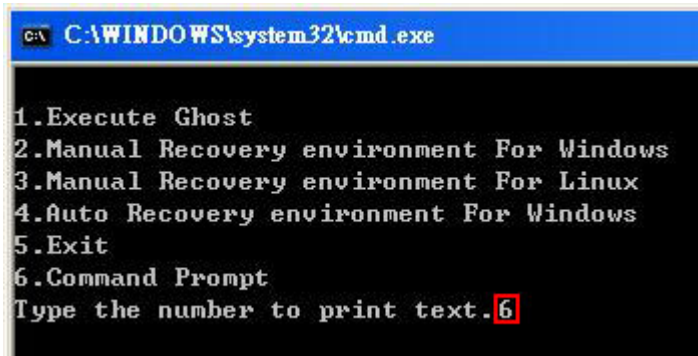

Figure B-3: Recovery Tool Setup Menu

**Step 4:** Press <6> then <Enter>.



## ICE-CV-D25502/N26002 COM Express Module



```
C:\WINDOWS\system32\cmd.exe

1.Execute Ghost
2.Manual Recovery environment For Windows
3.Manual Recovery environment For Linux
4.Auto Recovery environment For Windows
5.Exit
6.Command Prompt
Type the number to print text.6
```

Figure B-4: Command Prompt

**Step 5:** The command prompt window appears. Type the following commands (marked in red) to create two partitions. One is for the OS installation; the other is for saving recovery files and images which will be an invisible partition. (Press <Enter> after entering each line below)

```
system32>diskpart
DISKPART>list vol
DISKPART>sel disk 0
DISKPART>create part pri size= ____
DISKPART>assign letter=N
DISKPART>create part pri size= ____
DISKPART>assign letter=F
DISKPART>exit
system32>format N: /fs:ntfs /q /y
system32>format F: /fs:ntfs /q /v:Recovery /y
system32>exit
```

```

X:\I386\SYSTEM32\CMD.EXE
X:\I386\SYSTEM32>diskpart → Starts the Microsoft disk partitioning tool.

Microsoft DiskPart version 5.2.3790.1830
Copyright (C) 1999-2001 Microsoft Corporation.
On computer: MININT-JUC

DISKPART> list vol → Show partition information

   Volume ###  Ltr  Label          Fs      Type          Size      Status       Info
   -----  -  -  -  -  -  -  -  -
   Volume 0             X   CD_ROM        CDFS     DUD-ROM       405 MB    Healthy      Boot
   Volume 1             D                   FAT32    Removeable   3854 MB    Healthy

DISKPART> sel disk 0 → Select a disk

Disk 0 is now the selected disk.

DISKPART> create part pri size=2000 → Create partition 1 and assign a size.
                                       This partition is for OS installation.
DiskPart succeeded in creating the specified partition.

DISKPART> assign letter=N → Assign partition 1 a code name (N).
DiskPart successfully assigned the drive letter or mount point.

DISKPART> create part pri size=1800 → Create partition 2 and assign a size.
                                       This partition is for recovery images.
DiskPart succeeded in creating the specified partition.

DISKPART> assign letter=F → Assign partition 2 a code name (F).
DiskPart successfully assigned the drive letter or mount point.

DISKPART> exit → Exit diskpart

X:\I386\SYSTEM32>format n: /fs:ntfs /q /y → Format partition 1 (N) as NTFS format.
The type of the file system is RAW.
The new file system is NTFS.
QuickFormatting 2000M
Creating file system structures.
Format complete.
 2048254 KB total disk space.
 2035620 KB are available.

X:\I386\SYSTEM32>format f: /fs:ntfs /q /v:Recovery /y
The type of the file system is RAW.
The new file system is NTFS.
QuickFormatting 1804M
Creating file system structures.
Format complete.
 1847474 KB total disk space.
 1835860 KB are available.

X:\I386\SYSTEM32>exit → Exit Windows PE
  
```

**Figure B-5: Partition Creation Commands**



## NOTE:

Use the following commands to check if the partitions were created successfully.

```

X:\I386\SYSTEM32>diskpart
Microsoft DiskPart version 5.2.3790.1830
Copyright (C) 1999-2001 Microsoft Corporation.
On computer: MININT-JUC
DISKPART> sel disk 0
Disk 0 is now the selected disk.
DISKPART> list part
   Partition ###  Type              Size              Offset
-----
   Partition 1    Primary           2000 MB           32 KB
   Partition 2    Primary           1804 MB          2000 MB
DISKPART> exit
  
```

**Step 6:** Press any key to exit the recovery tool and automatically reboot the system.

Please continue to the following procedure: Build the Recovery Partition.

## B.2.3 Install Operating System, Drivers and Applications

Install the operating system onto the unlabelled partition. The partition labeled "Recovery" is for use by the system recovery tool and should not be used for installing the operating system or any applications.



## NOTE:

The operating system installation program may offer to reformat the chosen partition. DO NOT format the partition again. The partition has already been formatted and is ready for installing the new operating system.

To install the operating system, insert the operating system installation CD into the optical drive. Restart the computer and follow the installation instructions.

## B.2.4 Build-up Recovery Partition

- Step 1:** Put the recover CD in the optical drive.
- Step 2:** Start the system.
- Step 3:** **Boot the system from the recovery CD.** When prompted, press any key to boot from the recovery CD. It will take a while to launch the recovery tool. Please be patient!

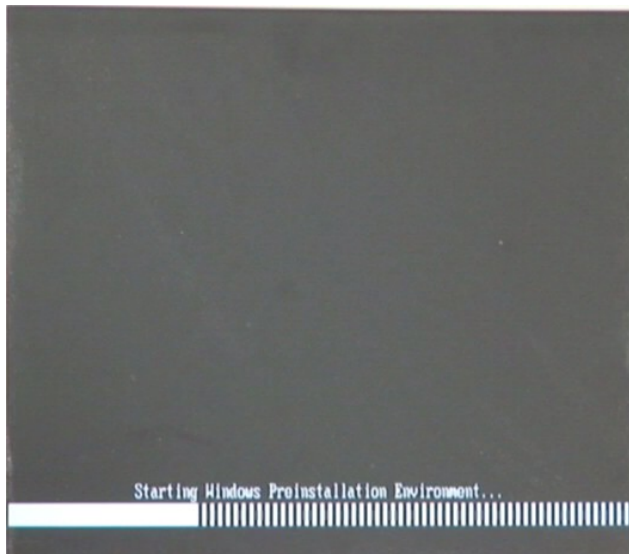

Figure B-6: Launching the Recovery Tool

- Step 4:** When the recovery tool setup menu appears, press <2> then <Enter>.

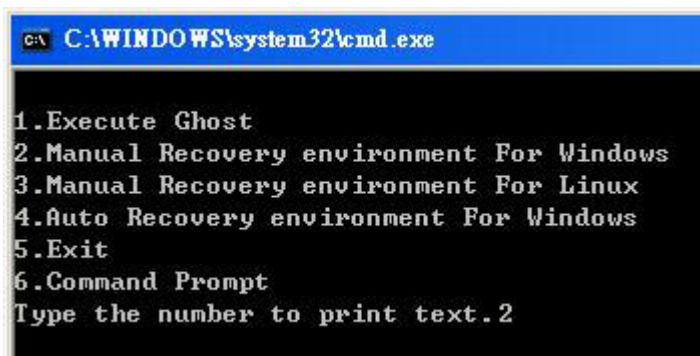
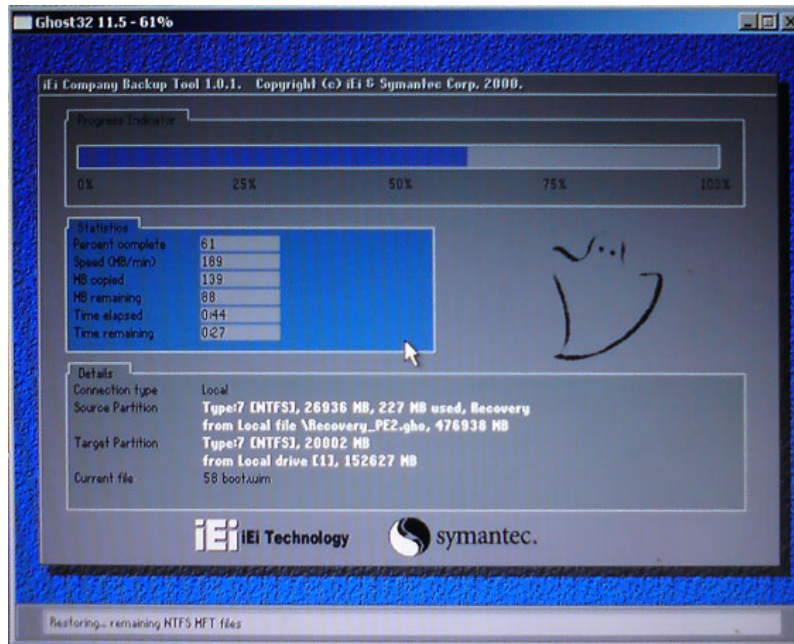

Figure B-7: Manual Recovery Environment for Windows

## ICE-CV-D25502/N26002 COM Express Module

**Step 5:** The Symantec Ghost window appears and starts configuring the system to build a recovery partition. In this process the partition created for recovery files in **Section B.2.2** is hidden and the recovery tool is saved in this partition.



**Figure B-8: Building the Recovery Partition**

**Step 6:** After completing the system configuration, press any key in the following window to reboot the system.

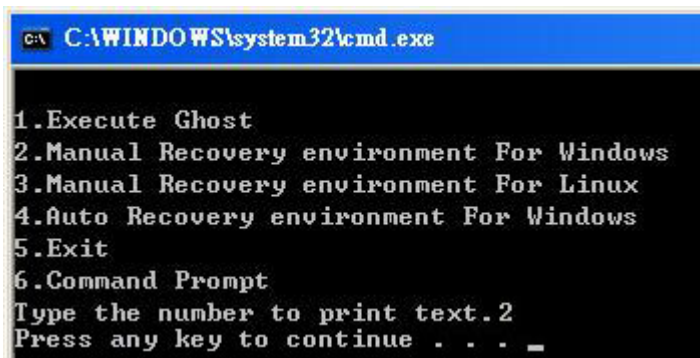

**Figure B-9: Press Any Key to Continue**

**Step 7:** Eject the recovery CD.

## B.2.5 Create Factory Default Image



### NOTE:

Before creating the factory default image, please configure the system to a factory default environment, including driver and application installations.

To create a factory default image, please follow the steps below.

**Step 1:** Turn on the system. When the following screen displays (**Figure B-10**), press the <F3> key to access the recovery tool. The message will display for 10 seconds, please press F3 before the system boots into the operating system.

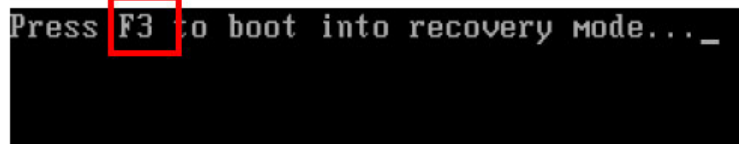

```
Press F3 to boot into recovery mode... _
```

Figure B-10: Press F3 to Boot into Recovery Mode

**Step 2:** The recovery tool menu appears. Type <4> and press <Enter>. (**Figure B-11**)

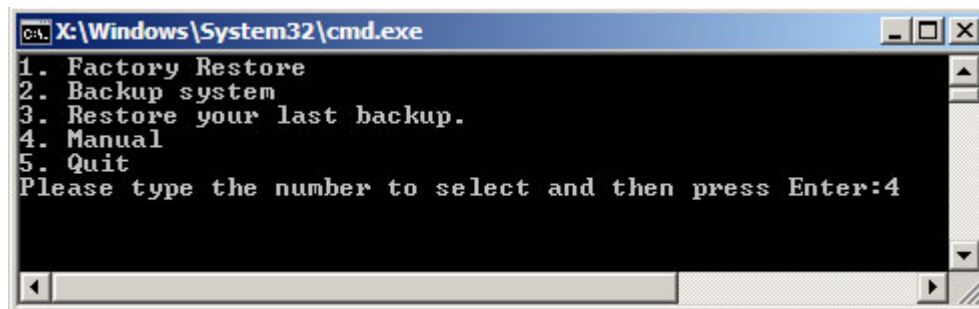

Figure B-11: Recovery Tool Menu

**Step 3:** The About Symantec Ghost window appears. Click **OK** button to continue.

ICE-CV-D25502/N26002 COM Express Module

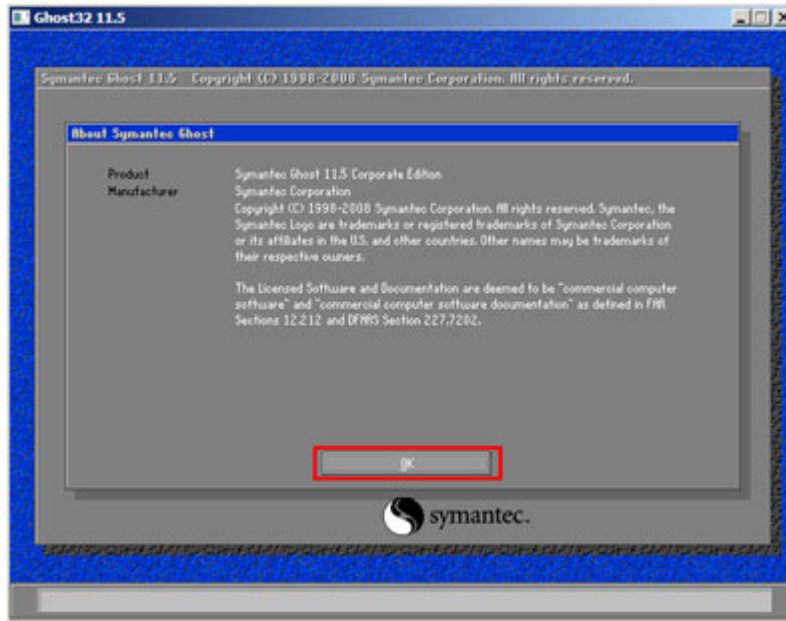

Figure B-12: About Symantec Ghost Window

**Step 4:** Use mouse to navigate to the option shown below (Figure B-13).

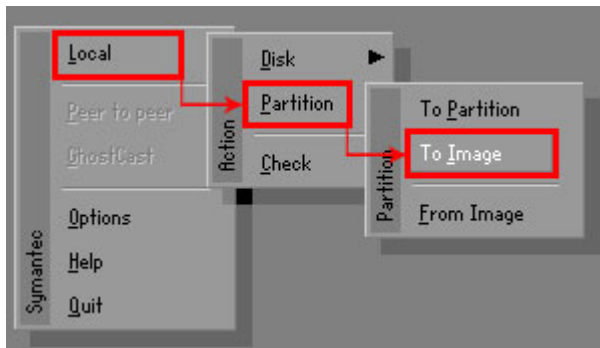
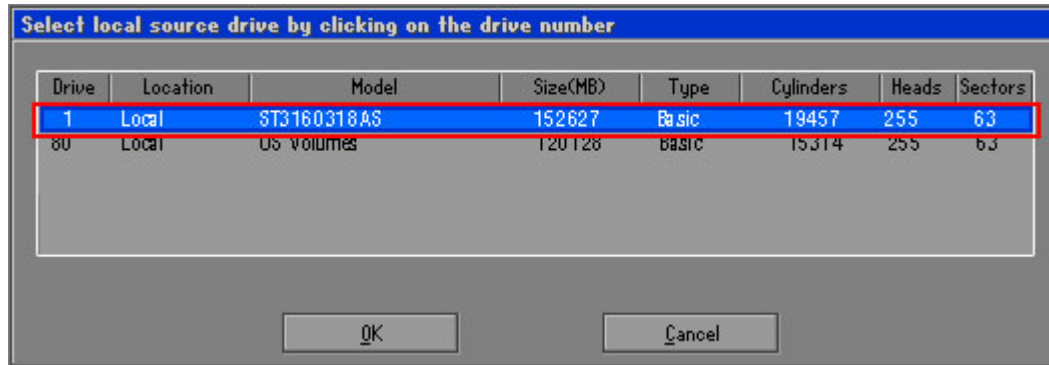

Figure B-13: Symantec Ghost Path

**Step 5:** Select the local source drive (Drive 1) as shown in Figure B-14. Then click OK.



**Figure B-14: Select a Local Source Drive**

**Step 6:** Select a source partition (Part 1) from basic drive as shown in **Figure B-15**. Then click OK.

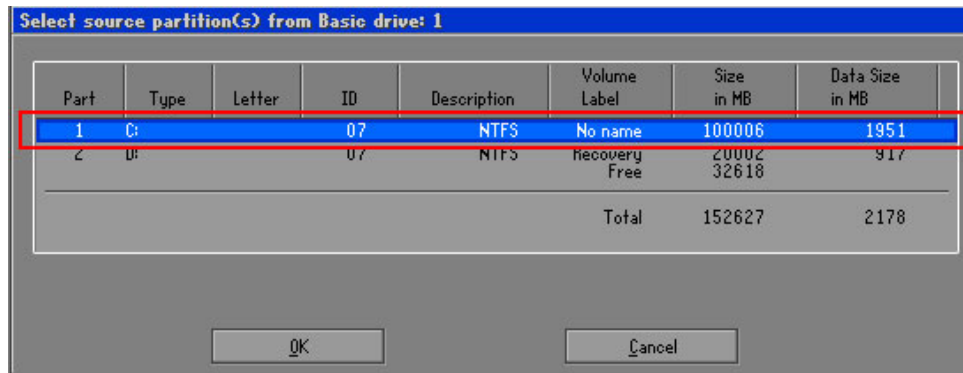

**Figure B-15: Select a Source Partition from Basic Drive**

**Step 7:** Select **1.2: [Recovery] NTFS drive** and enter a file name called **iei** (**Figure B-16**). Click **Save**. The factory default image will then be saved in the selected recovery drive and named **IEI.GHO**.



**WARNING:**

The file name of the factory default image must be **iei.GHO**.



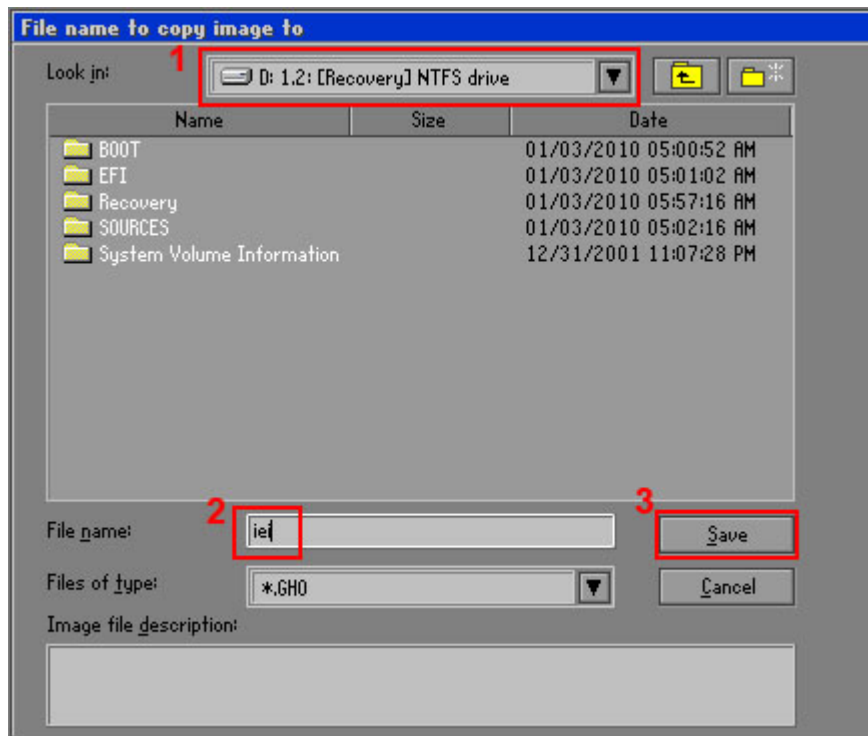

Figure B-16: File Name to Copy Image to

**Step 8:** When the Compress Image screen in **Figure B-17** prompts, click **High** to make the image file smaller.

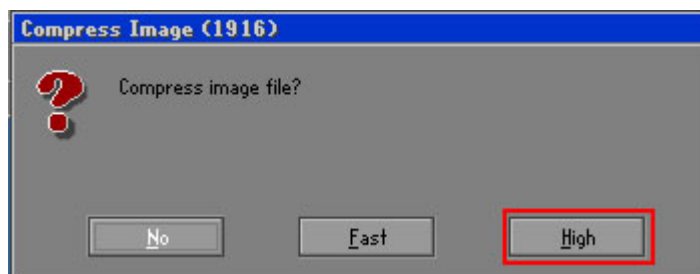
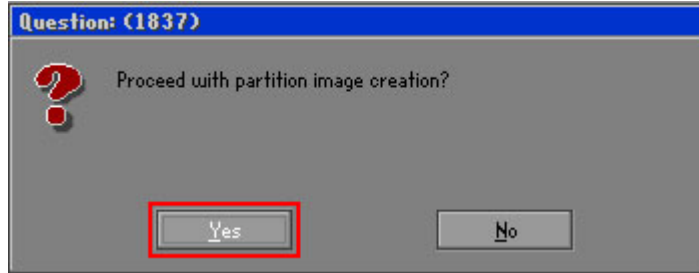

Figure B-17: Compress Image

**Step 9:** The Proceed with partition image creation window appears, click **Yes** to continue.



**Figure B-18: Image Creation Confirmation**

**Step 10:** The Symantec Ghost starts to create the factory default image (**Figure B-19**).

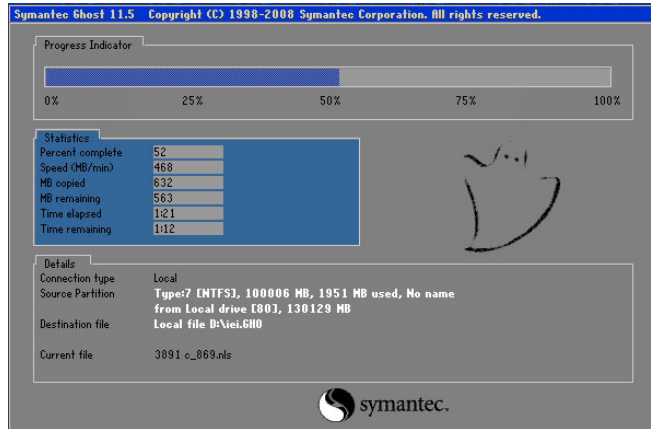

**Figure B-19: Image Creation Complete**

**Step 11:** When the image creation completes, a screen prompts as shown in **Figure B-20**.

Click **Continue** and close the Ghost window to exit the program.

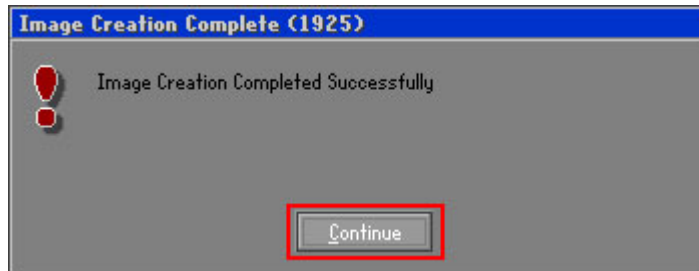

**Figure B-20: Image Creation Complete**

## ICE-CV-D25502/N26002 COM Express Module

**Step 12:** The recovery tool main menu window is shown as below. Press any key to reboot the system.

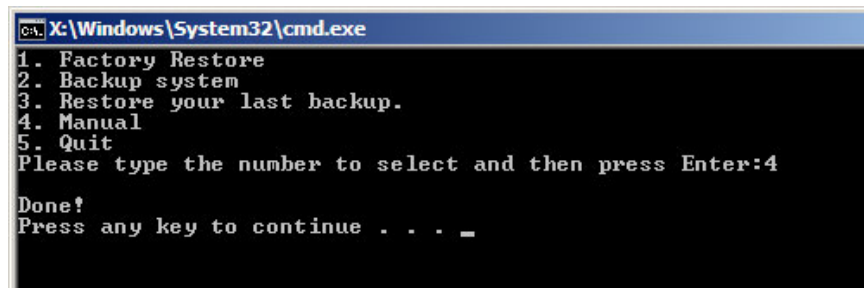

```
C:\Windows\System32\cmd.exe
1. Factory Restore
2. Backup system
3. Restore your last backup.
4. Manual
5. Quit
Please type the number to select and then press Enter:4
Done!
Press any key to continue . . . _
```

Figure B-21: Press Any Key to Continue

### B.3 Auto Recovery Setup Procedure

The auto recovery function allows a system to automatically restore from the factory default image after encountering a Blue Screen of Death (BSoD) or a hang for around 10 minutes. To use the auto recovery function, follow the steps described in the following sections.



#### CAUTION:

The auto recovery function can only run on a Microsoft Windows system with the following OS versions:

- Windows 2000
- Windows XP
- Windows Vista
- Windows 7
- Windows XP Embedded
- Windows Embedded Standard 7



#### CAUTION:

The setup procedure may include a step to create a factory default image. It is suggested to configure the system to a factory default environment before the configuration, including driver and application installations.

---

**Step 1:** Follow the steps described in **Section B.2.1 ~ Section B.2.3** to setup BIOS, create partitions and install operating system.

**Step 2:** Install the auto recovery utility into the system by double clicking the **Utility/AUTORECOVERY-SETUP.exe** in the One Key Recovery CD. This utility **MUST** be installed in the system, otherwise, the system will automatically restore from the factory default image every ten (10) minutes.



**Figure B-22: Auto Recovery Utility**

**Step 3:** **Disable the automatically restart function before creating the factory default image.** Go to: My Computer → Properties → Advanced. Click the Settings button of Startup and Recovery. Deselect “Automatically restart”. Click OK to save the settings and exit. (See **Figure B-23**)

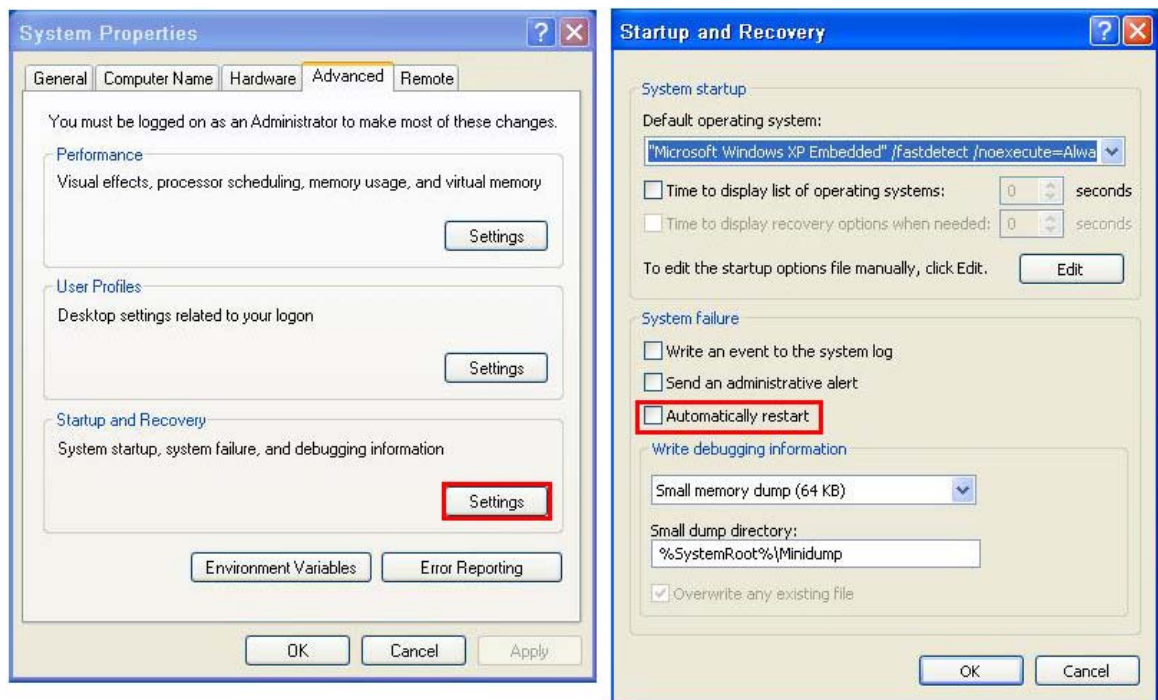

**Figure B-23: Disable Automatically Restart**

## ICE-CV-D25502/N26002 COM Express Module

**Step 4:** Reboot the system from the recovery CD. When prompted, press any key to boot from the recovery CD. It will take a while to launch the recovery tool. Please be patient!

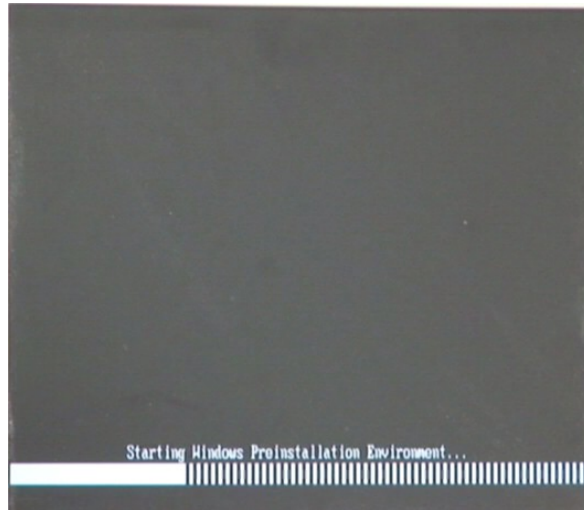

Figure B-24: Launching the Recovery Tool

**Step 5:** When the recovery tool setup menu appears, press <4> then <Enter>.

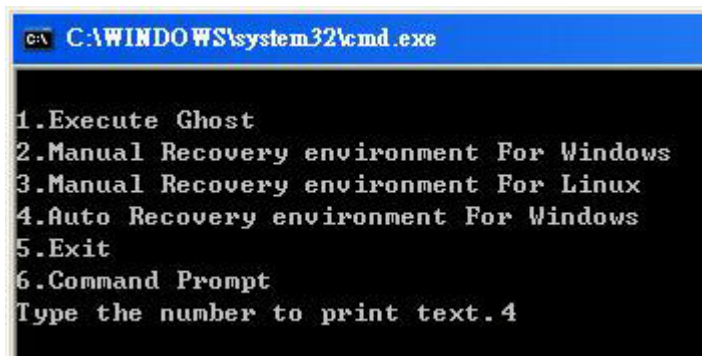
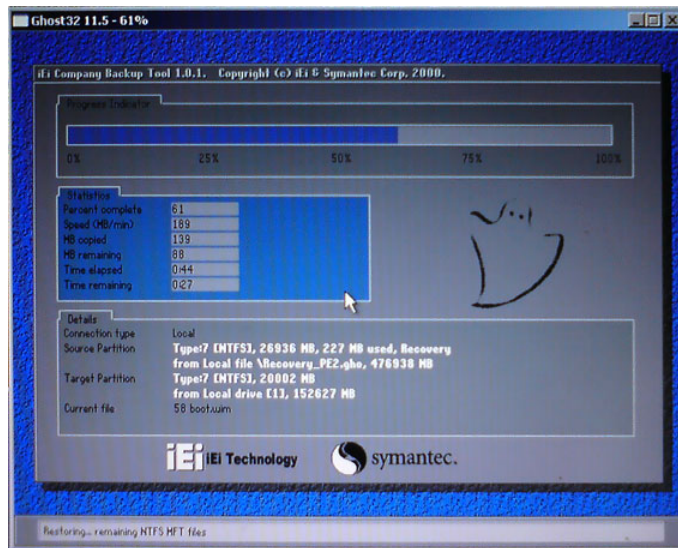

Figure B-25: Auto Recovery Environment for Windows

**Step 6:** The Symantec Ghost window appears and starts configuring the system to build an auto recovery partition. In this process the partition created for recovery files in **Section B.2.2** is hidden and the auto recovery tool is saved in this partition.



**Figure B-26: Building the Auto Recovery Partition**

**Step 7:** After completing the system configuration, the following message prompts to confirm whether to create a factory default image. Type **Y** to have the system create a factory default image automatically. Type **N** within 6 seconds to skip this process (The default option is YES). It is suggested to choose YES for this option.



**Figure B-27: Factory Default Image Confirmation**

## ICE-CV-D25502/N26002 COM Express Module

**Step 8:** The Symantec Ghost starts to create the factory default image (**Figure B-28**).

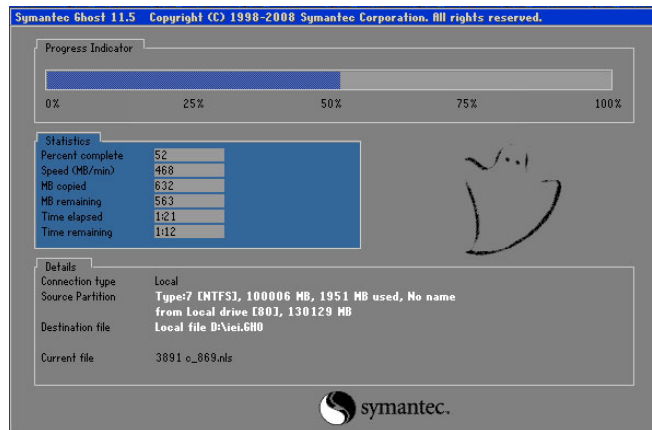

**Figure B-28: Image Creation Complete**

**Step 9:** After completing the system configuration, press any key in the following window to restart the system.

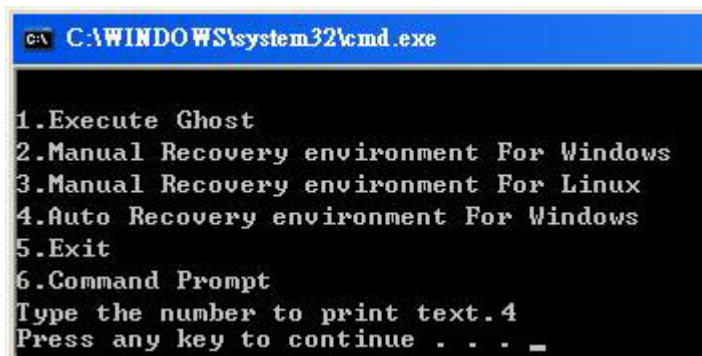
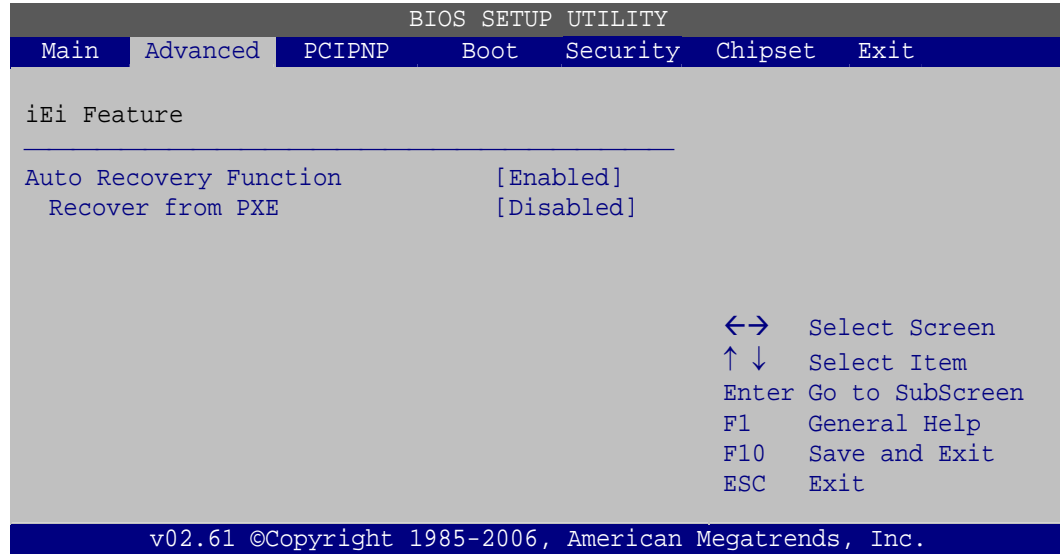

**Figure B-29: Press any key to continue**

**Step 10:** Eject the One Key Recovery CD and restart the system.

**Step 11:** Press the <DELETE> key as soon as the system is turned on to enter the BIOS.

**Step 12:** Enable the Auto Recovery Function option (**Advanced** → **iEi Feature** → **Auto Recovery Function**).



**Figure B-30: IEI Feature**

**Step 13:** Save changes and restart the system. If the system encounters a Blue Screen of Death (BSoD) or a hang for around 10 minutes, it will automatically restore from the factory default image.

## B.4 Setup Procedure for Linux

The initial setup procedures for a Linux system are mostly the same with the procedure for Microsoft Windows. Please follow the steps below to setup the recovery tool for Linux OS.

**Step 1:** Hardware and BIOS setup. Refer to **Section B.2.1**.

**Step 2: Install Linux operating system.** Make sure to install GRUB (v0.97 or earlier) MBR type and Ext3 partition type. Leave enough space on the hard drive to create the recover partition later.



**NOTE:**

If the Linux OS is not installed with GRUB (v0.97 or earlier) and Ext3, the Symantec Ghost may not function properly.

While installing Linux OS, please create two partitions:



## ICE-CV-D25502/N26002 COM Express Module

- Partition 1: /
- Partition 2: SWAP

**NOTE:**

Please reserve enough space for partition 3 for saving recovery images.

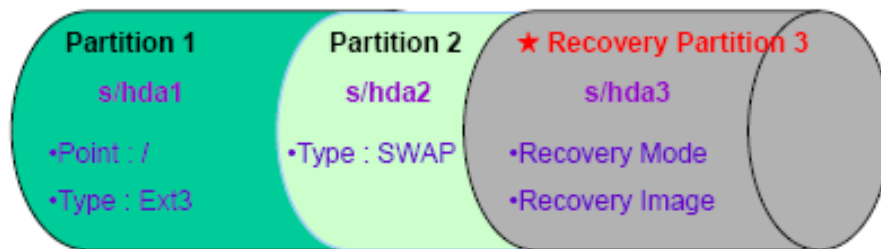

Figure B-31: Partitions for Linux

**Step 3:** Create a recovery partition. Insert the recovery CD into the optical disk drive.

Follow **Step 1 ~ Step 3** described in **Section B.2.2**. Then type the following commands (marked in red) to create a partition for recovery images.

```
system32>diskpart
DISKPART>list vol
DISKPART>sel disk 0
DISKPART>create part pri size= ____
DISKPART>assign letter=N
DISKPART>exit
system32>format N: /fs:ntfs /q /v:Recovery /y
system32>exit
```

**Step 4:** Build-up recovery partition. Press any key to boot from the recovery CD. It will take a while to launch the recovery tool. Please be patient. When the recovery tool setup menu appears, type <3> and press <Enter> (**Figure B-32**). The Symantec Ghost window appears and starts configuring the system to build-up a

recovery partition. After completing the system configuration, press any key to reboot the system. Eject the recovery CD.

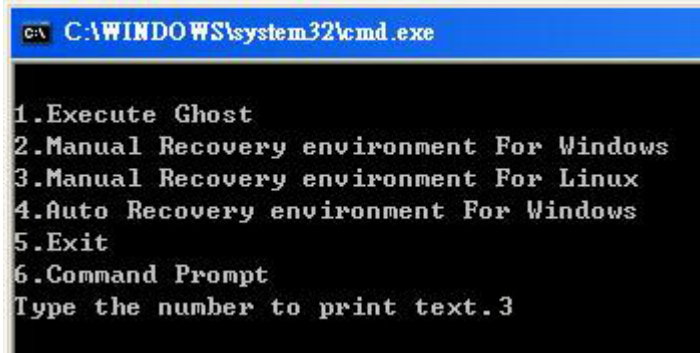

```

C:\WINDOWS\system32\cmd.exe

1.Execute Ghost
2.Manual Recovery environment For Windows
3.Manual Recovery environment For Linux
4.Auto Recovery environment For Windows
5.Exit
6.Command Prompt
Type the number to print text.3
    
```

**Figure B-32: System Configuration for Linux**

**Step 5:** Access the recovery tool main menu by modifying the “menu.lst”. To first access the recovery tool main menu, the menu.lst must be modified. In Linux, enter Administrator (root). When prompt appears, type:

**cd /boot/grub**

**vi menu.lst**

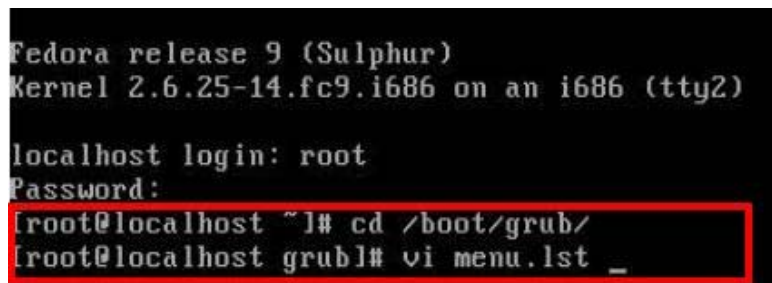

```

Fedora release 9 (Sulphur)
Kernel 2.6.25-14.fc9.i686 on an i686 (tty2)

localhost login: root
Password:
[root@localhost ~]# cd /boot/grub/
[root@localhost grub]# vi menu.lst
    
```

**Figure B-33: Access menu.lst in Linux (Text Mode)**

**Step 6:** Modify the menu.lst as shown below.

```
#boot=/dev/sda
default=0
timeout=10 ← Modify timeout=10
splashimage=(hd0,0)/grub/splash.xpm.gz
hiddenmenu
title Fedora (2.6.25-14.fc9.i686)
    root (hd0,0)
    kernel /vmlinuz-2.6.25-14.fc9.i686 ro root=UUID=10f1acd
ac38b5c78910 rhgb quiet
    initrd /initrd-2.6.25-14.fc9.i686.img

title Recovery Partition
root (hd0,2)
makeactive ← Type command
chainloader +1
```

- Type command:  
**title Recovery Partition**  
**root (hd0,2)**  
**makeactive**  
**chainloader +1**

**Step 7:** The recovery tool menu appears. (Figure B-34)

```
1. Factory Restore
2. Backup system
3. Restore your last backup.
4. Manual
5. Quit
Please type the number to select and then press Enter:
```

Figure B-34: Recovery Tool Menu

**Step 8:** Create a factory default image. Follow **Step 2 ~ Step 12** described in **Section B.2.5** to create a factory default image.

## B.5 Recovery Tool Functions

After completing the initial setup procedures as described above, users can access the recovery tool by pressing <F3> while booting up the system. However, if the setup procedure in Section B.3 has been completed and the auto recovery function is enabled, the system will automatically restore from the factory default image without pressing the F3 key. The recovery tool main menu is shown below.

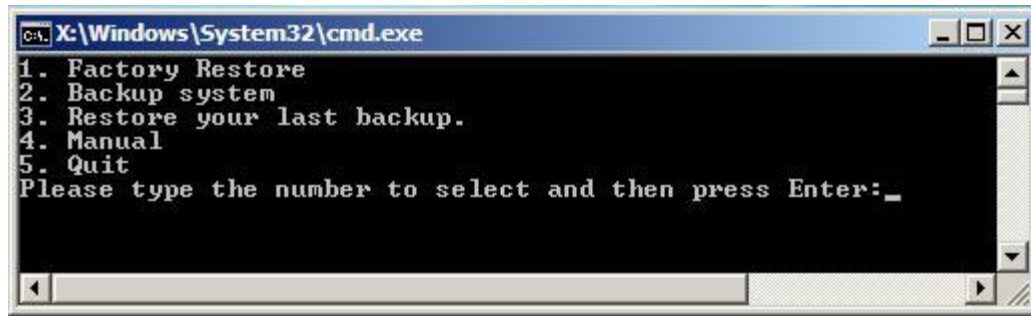

Figure B-35: Recovery Tool Main Menu

The recovery tool has several functions including:

1. **Factory Restore:** Restore the factory default image (iei.GHO) created in **Section B.2.5**.
2. **Backup system:** Create a system backup image (iei\_user.GHO) which will be saved in the hidden partition.
3. **Restore your last backup:** Restore the last system backup image
4. **Manual:** Enter the Symantec Ghost window to configure manually.
5. **Quit:** Exit the recovery tool and restart the system.



**WARNING:**

Please do not turn off the system power during the process of system recovery or backup.



**WARNING:**

All data in the system will be deleted during the system recovery. Please backup the system files before restoring the system (either Factory Restore or Restore Backup).

## ICE-CV-D25502/N26002 COM Express Module

### B.5.1 Factory Restore

To restore the factory default image, please follow the steps below.

**Step 1:** Type <1> and press <Enter> in the main menu.

**Step 2:** The Symantec Ghost window appears and starts to restore the factory default. A factory default image called **iei.GHO** is created in the hidden Recovery partition.

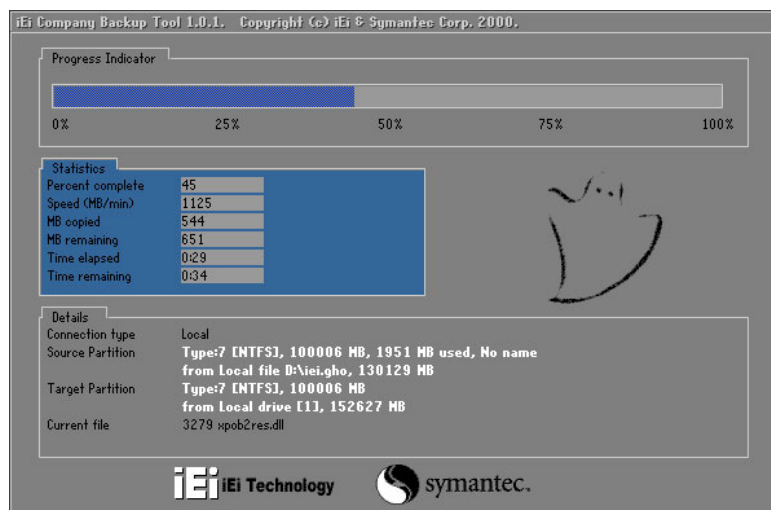

Figure B-36: Restore Factory Default

**Step 3:** The screen is shown in **Figure B-37** appears when completed. Press any key to reboot the system.

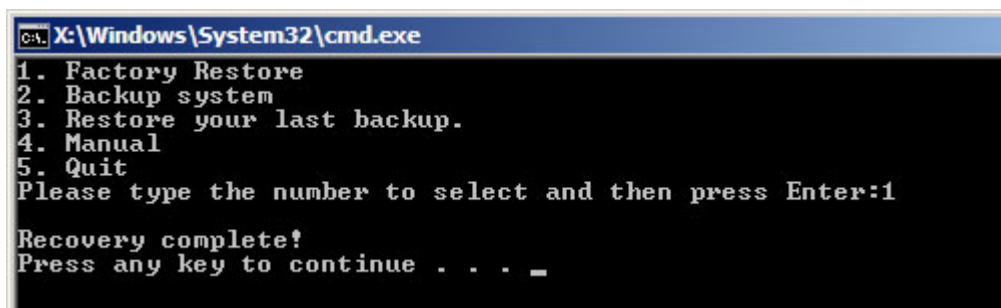

Figure B-37: Recovery Complete Window

## B.5.2 Backup System

To backup the system, please follow the steps below.

**Step 1:** Type <2> and press <Enter> in the main menu.

**Step 2:** The Symantec Ghost window appears and starts to backup the system. A backup image called `iei_user.GHO` is created in the hidden Recovery partition.

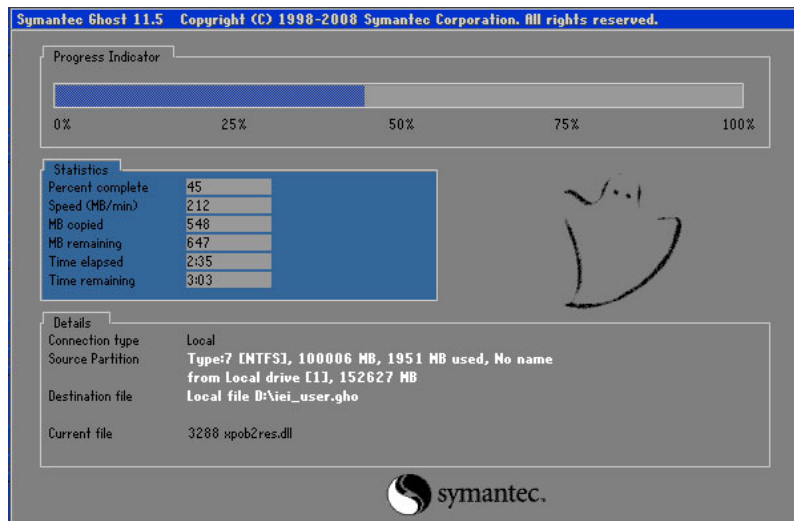

**Figure B-38: Backup System**

**Step 3:** The screen is shown in **Figure B-39** appears when system backup is complete. Press any key to reboot the system.

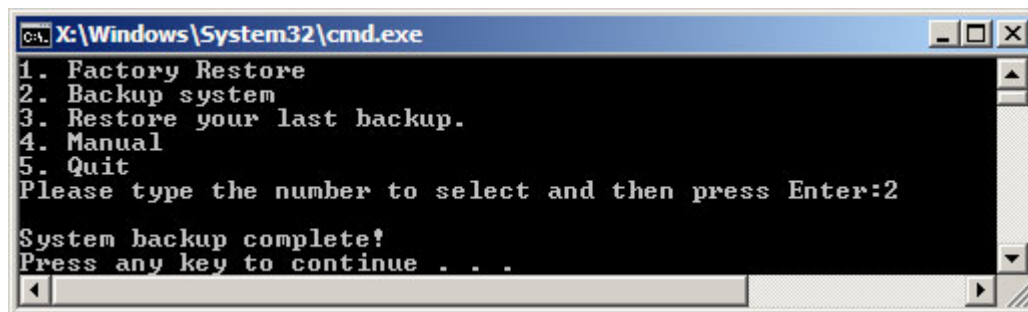

**Figure B-39: System Backup Complete Window**

## ICE-CV-D25502/N26002 COM Express Module

### B.5.3 Restore Your Last Backup

To restore the last system backup, please follow the steps below.

**Step 1:** Type <3> and press <Enter> in the main menu.

**Step 2:** The Symantec Ghost window appears and starts to restore the last backup image (iei\_user.GHO).

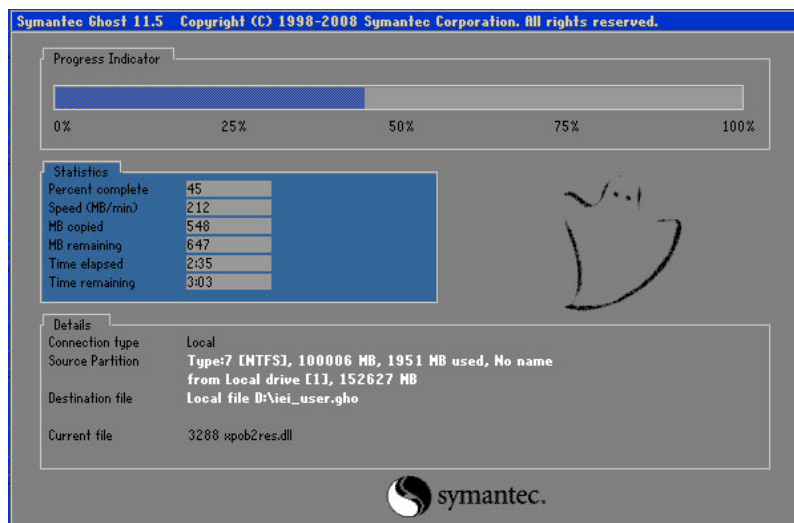

Figure B-40: Restore Backup

**Step 3:** The screen shown in **Figure B-41** appears when backup recovery is complete. Press any key to reboot the system.

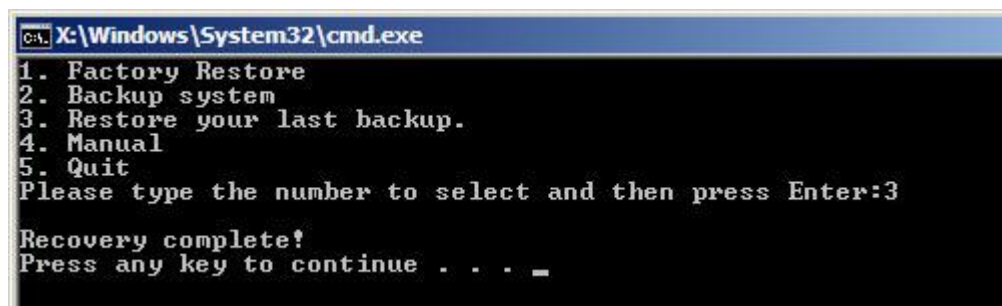

Figure B-41: Restore System Backup Complete Window

## B.5.4 Manual

To restore the last system backup, please follow the steps below.

**Step 1:** Type <4> and press <Enter> in the main menu.

**Step 2:** The Symantec Ghost window appears. Use the Ghost program to backup or recover the system manually.

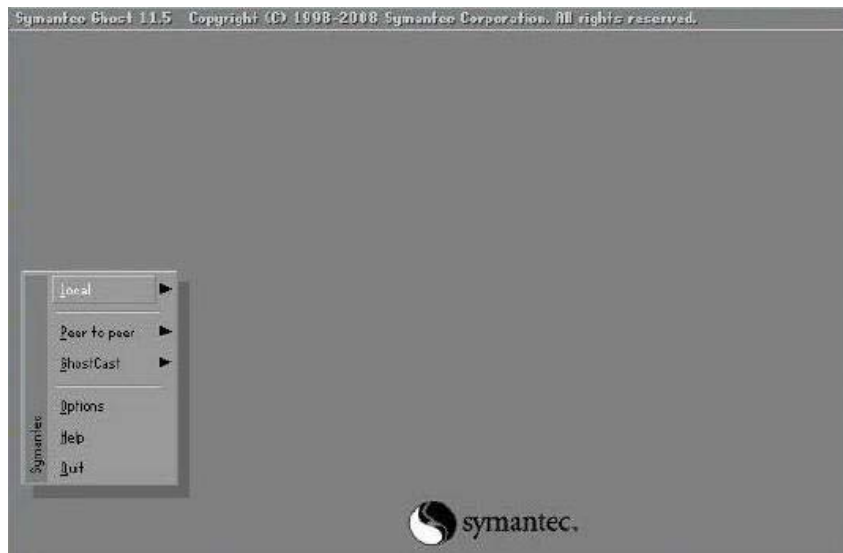

Figure B-42: Symantec Ghost Window

**Step 3:** When backup or recovery is completed, press any key to reboot the system.



## B.6 Restore Systems from a Linux Server through LAN

The One Key Recovery allows a client system to automatically restore to a factory default image saved in a Linux system (the server) through LAN connectivity after encountering a Blue Screen of Death (BSOD) or a hang for around 10 minutes. To be able to use this function, the client system and the Linux system MUST reside in the same domain.

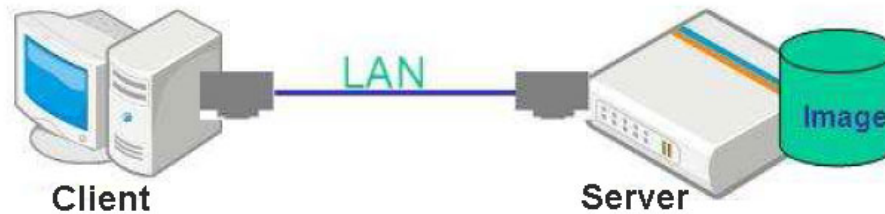

### CAUTION:

The supported client OS includes:

- Windows 2000
- Windows XP
- Windows Vista
- Windows 7
- Windows XP Embedded
- Windows Embedded Standard 7

Prior to restoring client systems from a Linux server, a few setup procedures are required.

**Step 1:** Configure DHCP server settings

**Step 2:** Configure TFTP settings

**Step 3:** Configure One Key Recovery server settings

**Step 4:** Start DHCP, TFTP and HTTP

**Step 5:** Create a shared directory

**Step 6:** Setup a client system for auto recovery

The detailed descriptions are described in the following sections. In this document, two types of Linux OS are used as examples to explain the configuration process – CentOS 5.5 (Kernel 2.6.18) and Debian 5.0.7 (Kernel 2.6.26).

## B.6.1 Configure DHCP Server Settings

**Step 1:** Install the DHCP

`#yum install dhcp` (CentOS, commands marked in red)

`#apt-get install dhcp3-server` (Debian, commands marked in blue)

**Step 2:** Confirm the operating system default settings: dhcpd.conf.

### CentOS

Use the following command to show the DHCP server sample location:

`#vi /etc/dhcpd.conf`

The DHCP server sample location is shown as below:

```
# DHCP Server Configuration file.
# see /usr/share/doc/dhcp*/dhcpd.conf.sample
#
```

Use the following command to copy the DHCP server sample to etc/dhcpd.conf:

`#cp /usr/share/doc/dhcp-3.0.5/dhcpd.conf.sample /etc/dhcpd.conf`

`#vi /etc/dhcpd.conf`

```
ddns-update-style interim;
ignore client-updates;

subnet 192.168.0.0 netmask 255.255.255.0 {
# --- default gateway
    option routers                192.168.0.2;
    option subnet-mask            255.255.255.0;

    option nis-domain             "domain.org";
    option domain-name            "domain.org";
    option domain-name-servers   192.168.0.1;
    next-server 192.168.0.6;
    filename "pxelinux.0";
    option time-offset            -18000; # Eastern Standard Time
    option ntp-servers            192.168.1.1;
    option netbios-name-servers  192.168.1.1;
}
```

### Debian

`#vi /etc/dhcpd.conf`

Edit “/etc/dhcpd.conf” for your environment. For example, add

`next-server PXE server IP address;`

filename "pxelinux.0";

```
ddns-update-style interim;
ignore client-updates;

subnet 192.168.0.0 netmask 255.255.255.0 {
# --- default gateway
    option routers                192.168.0.2;
    option subnet-mask            255.255.255.0;

    option nis-domain             "domain.org";
    option domain-name            "domain.org";
    option domain-name-servers   192.168.0.1;
    next-server 192.168.0.6;
    filename "pxelinux.0";
    option time-offset            -18000; # Eastern Standard Time
    option ntp-servers            192.168.1.1;
}
```

## B.6.2 Configure TFTP Settings

**Step 1:** Install the tftp, httpd and syslinux.

`#yum install tftp-server httpd syslinux` (CentOS)

`#apt-get install tftpd-hpa xinetd syslinux` (Debian)

**Step 2:** Enable the TFTP server by editing the "/etc/xinetd.d/tftp" file and make it use the remap file. The "-vvv" is optional but it could definitely help on getting more information while running the remap file. For example:

### CentOS

`#vi /etc/xinetd.d/tftp`

Modify:

`disable = no`

`server_args = -s /tftpboot -m /tftpboot/tftpd.remap -vvv_`

```
socket_type      = dgram
protocol        = udp
wait            = yes
user            = root
server          = /usr/sbin/in.tftpd
server_args     = -s /tftpboot -m /tftpboot/tftpd.remap -vvv
disable         = no
per_source      = 11
cps             = 100 2
flags           = IPv4
```

### Debian

Replace the TFTP settings from “inetd” to “xinetd” and annotate the “inetd” by adding “#”.

`#vi /etc/inetd.conf`

Modify: `#tftp dgram udp wait root /usr/sbin.....` (as shown below)

```
#:BOOT: TFTP service is provided primarily for booting. Most sites
#      run this only on machines acting as "boot servers."
#tftp  dgram  udp   wait  root  /usr/sbin/in.tftpd /usr/sbin/in.tftpd -s
      /var/lib/tftpboot
```

`#vi /etc/xinetd.d/tftp`

```
socket_type      = dgram
protocol        = udp
wait            = yes
user            = root
server          = /usr/sbin/in.tftpd
server_args     = -s /tftpboot -n /tftpboot/tftpd.remap -vvv
disable         = no
per_source      = 11
cps             = 100 2
flags           = IPv4
```

## B.6.3 Configure One Key Recovery Server Settings

**Step 1:** Copy the **Utility/RECOVERYR10.TAR.BZ2** package from the One Key Recovery CD to the system (server side).



**Step 2:** Extract the recovery package to /.

```
#cp RecoveryR10.tar.bz2 /
#cd /
#tar -xvzf RecoveryR10.tar.bz2
```

**Step 3:** Copy “pxelinux.0” from “syslinux” and install to “tftpboot”.

```
#cp /usr/lib/syslinux/pxelinux.0 /tftpboot/
```

### B.6.4 Start the DHCP, TFTP and HTTP

Start the DHCP, TFTP and HTTP. For example:

#### CentOS

```
#service xinetd restart
```

```
#service httpd restart
```

```
#service dhcpd restart
```

#### Debian

```
#/etc/init.d/xinetd reload
```

```
#/etc/init.d/xinetd restart
```

```
#/etc/init.d/dhcp3-server restart
```

### B.6.5 Create Shared Directory

**Step 1:** Install the samba.

```
#yum install samba
```

**Step 2:** Create a shared directory for the factory default image.

```
#mkdir /share
```

```
#cd /share
```

```
#mkdir /image
```

```
#cp iei.gho /image
```



#### **WARNING:**

The file name of the factory default image must be **iei.gho**.

---

**Step 3:** Confirm the operating system default settings: smb.conf.

```
#vi /etc/samba/smb.conf
```

Modify:

[image]

comment = One Key Recovery

path = /share/image

browseable = yes

writable = yes

public = yes

create mask = 0644

directory mask = 0755

**Step 4:** Edit “/etc/samba/smb.conf” for your environment. For example:

```
# "security = user" is always a good idea. This will require a Unix account
# in this server for every user accessing the server. See
# /usr/share/doc/samba-doc/htmldocs/Samba3-HOWTO/ServerType.html
# in the samba-doc package for details.
security = share
```

```
[image]
comment = One Key Recovery
path = /share/image
browseable = yes
writable = yes
public = yes
create mask = 0644
directory mask = 0755
```

**Step 5:** Modify the hostname

```
#vi /etc/hostname
```

Modify: RecoveryServer

```
RecoveryServer
```

## B.6.6 Setup a Client System for Auto Recovery

**Step 1:** Disable the automatically restart function before creating the factory default image. Go to: My Computer → Properties → Advanced. Click the Settings button of Startup and Recovery. Deselect “Automatically restart”. Click OK to save the settings and exit. (See **Figure B-43**)

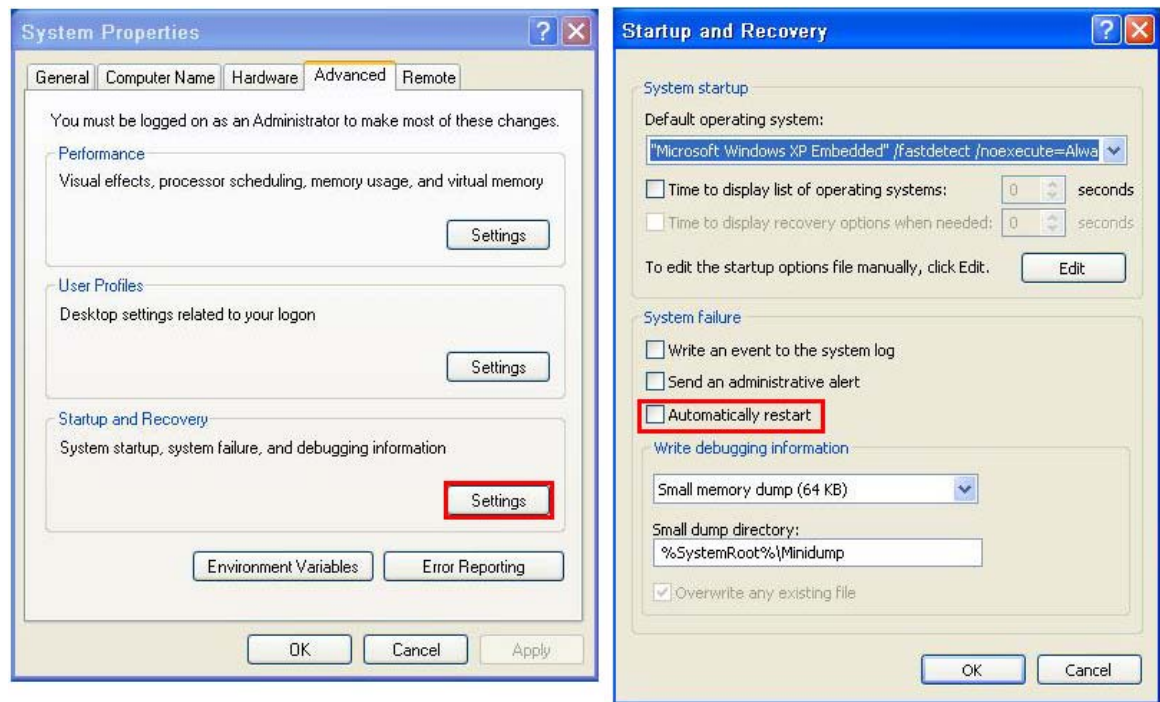

**Figure B-43: Disable Automatically Restart**

- Step 2:** Configure the following BIOS options of the client system.
  - Advanced → iEi Feature → Auto Recovery Function → **Enabled**
  - Advanced → iEi Feature → Recover from PXE → **Enabled**
  - Boot → Launch PXE OpROM → **Enabled**
  
- Step 3:** Continue to configure the **Boot Option Priorities** BIOS option of the client system:
  - Boot Option #1 → remain the default setting to boot from the original OS.
  - Boot Option #2 → select the boot from LAN option.
  
- Step 4:** Save changes and exit BIOS menu.
  - Exit → **Save Changes and Exit**
  
- Step 5:** Install the auto recovery utility into the system by double clicking the **Utility/AUTORECOVERY-SETUP.exe** in the One Key Recovery CD. This utility

MUST be installed in the system, otherwise, the system will automatically restore from the factory default image every ten (10) minutes.



**Step 6:** Restart the client system from LAN. If the system encounters a Blue Screen of Death (BSoD) or a hang for around 10 minutes, it will automatically restore from the factory default image. The following screens will show when the system starts auto recovering.

```
Realtek PCIe GBE Family Controller Series v2.35 (06/14/10)
CLIENT MAC ADDR: 00 18 7D 13 E6 89  GUID: 00020003-0004-0005-0006-0007000000
DHCP . ./
```

```
My IP address seems to be C0A80009 192.168.0.9
ip=192.168.0.9:192.168.0.8:192.168.0.2:255.255.255.0
TFTP prefix:
Trying to load: pxelinux.cfg/00020003-0004-0005-0006-000700000009
Trying to load: pxelinux.cfg/01-00-18-7d-13-e6-89
Trying to load: pxelinux.cfg/C0A80009
Trying to load: pxelinux.cfg/C0A8000
Trying to load: pxelinux.cfg/C0A800
Trying to load: pxelinux.cfg/C0A80
Trying to load: pxelinux.cfg/C0A8
Trying to load: pxelinux.cfg/C0A
Trying to load: pxelinux.cfg/C0
Trying to load: pxelinux.cfg/C
Trying to load: pxelinux.cfg/default
boot:
```

```
Windows is loading files...
IP: 192.168.0.8, File: \Boot\WinPE.wim
```



## ICE-CV-D25502/N26002 COM Express Module

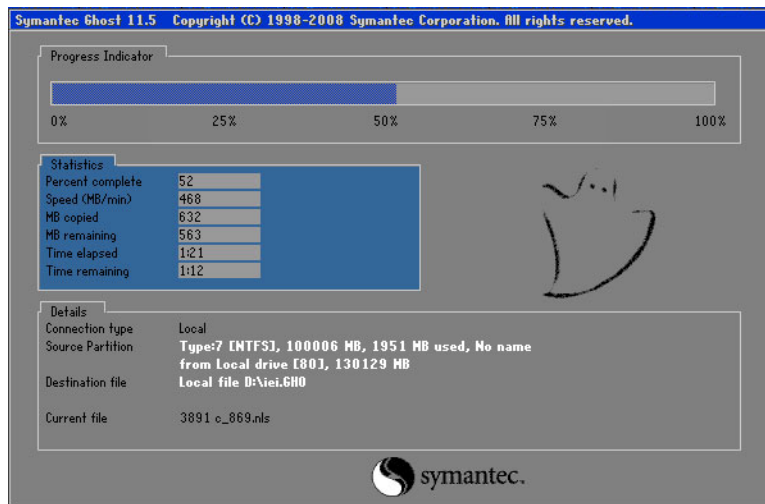

### NOTE:

A firewall or a SELinux is not in use in the whole setup process described above. If there is a firewall or a SELinux protecting the system, modify the configuration information to accommodate them.

## B.7 Other Information

### B.7.1 Using AHCI Mode or ALi M5283 / VIA VT6421A Controller

When the system uses AHCI mode or some specific SATA controllers such as ALi M5283 or VIA VT6421A, the SATA RAID/AHCI driver must be installed before using one key recovery. Please follow the steps below to install the SATA RAID/AHCI driver.

- Step 1:** Copy the SATA RAID/AHCI driver to a floppy disk and insert the floppy disk into a USB floppy disk drive. The SATA RAID/AHCI driver must be especially designed for the on-board SATA controller.
- Step 2:** Connect the USB floppy disk drive to the system.
- Step 3:** Insert the One Key Recovery CD into the system and boot the system from the CD.
- Step 4:** When launching the recovery tool, press <F6>.

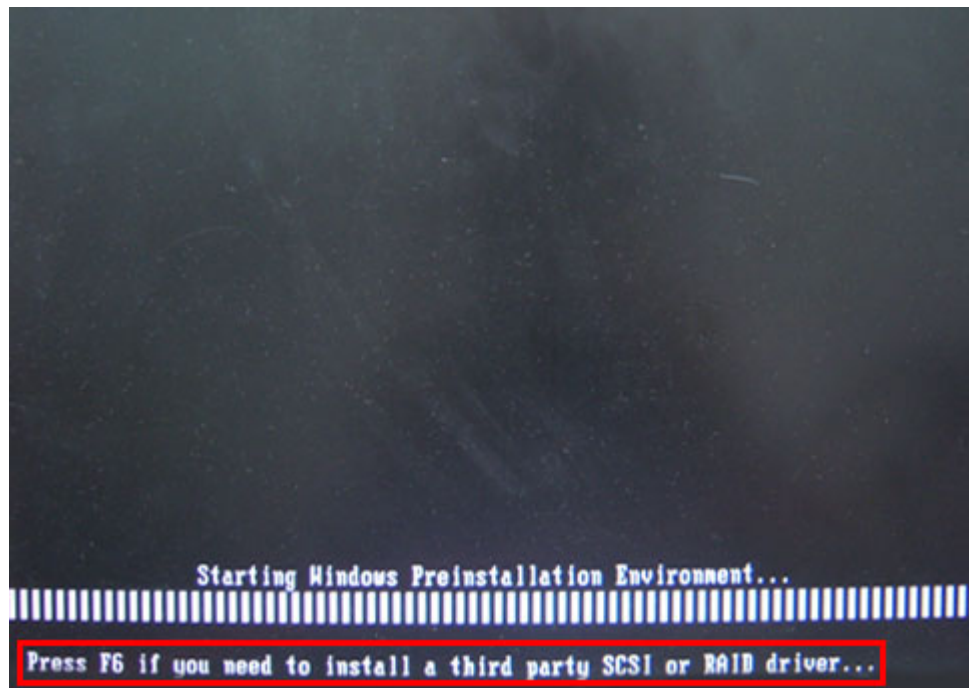

**Step 5:** When the following window appears, press <S> to select “Specify Additional Device”.

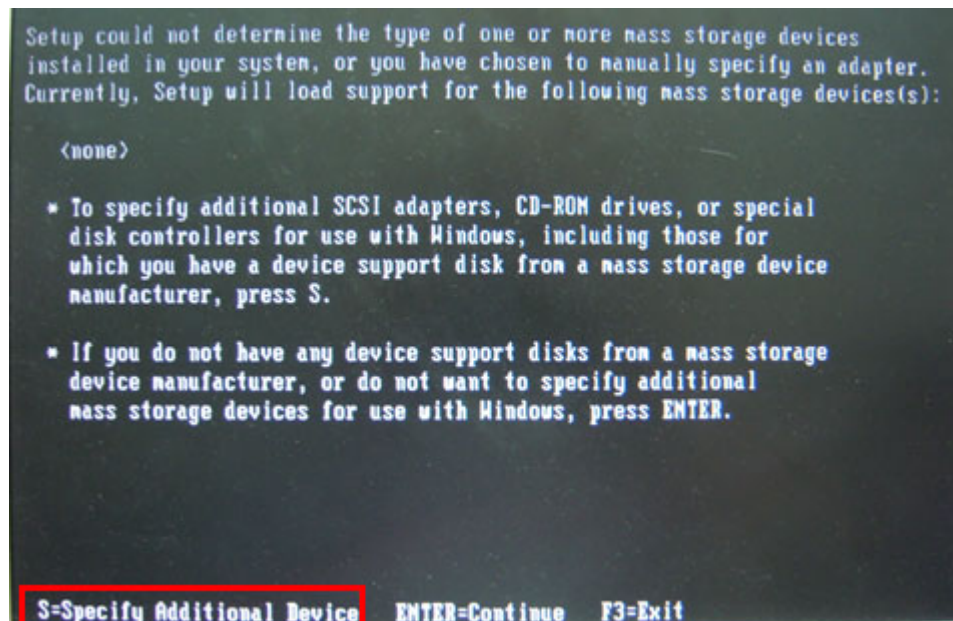

## ICE-CV-D25502/N26002 COM Express Module

**Step 6:** In the following window, select a SATA controller mode used in the system. Then press <Enter>. The user can now start using the SATA HDD.

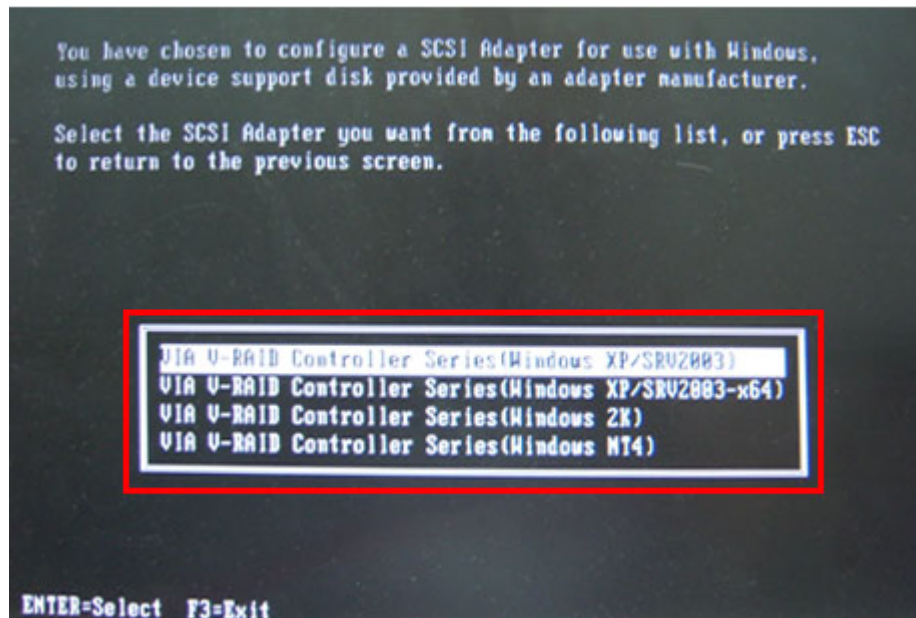

**Step 7:** After pressing <Enter>, the system will get into the recovery tool setup menu. Continue to follow the setup procedure from **Step 4** in **Section B.2.2 Create Partitions** to finish the whole setup process.

### B.7.2 System Memory Requirement

To be able to access the recovery tool by pressing <F3> while booting up the system, please make sure to have enough system memory. The minimum memory requirement is listed below.

- **Using Award BIOS:** 128 MB system memory
- **Using AMI BIOS:** 512 MB system memory.

Appendix

C

# Terminology

---

## ICE-CV-D25502/N26002 COM Express Module

<b>AC '97</b>	Audio Codec 97 (AC'97) refers to a codec standard developed by Intel® in 1997.
<b>ACPI</b>	Advanced Configuration and Power Interface (ACPI) is an OS-directed configuration, power management, and thermal management interface.
<b>AHCI</b>	Advanced Host Controller Interface (AHCI) is a SATA Host controller register-level interface.
<b>ATA</b>	The Advanced Technology Attachment (ATA) interface connects storage devices including hard disks and CD-ROM drives to a computer.
<b>ARMD</b>	An ATAPI Removable Media Device (ARMD) is any ATAPI device that supports removable media, besides CD and DVD drives.
<b>ASKIR</b>	Amplitude Shift Keyed Infrared (ASKIR) is a form of modulation that represents a digital signal by varying the amplitude (“volume”) of the signal. A low amplitude signal represents a binary 0, while a high amplitude signal represents a binary 1.
<b>BIOS</b>	The Basic Input/Output System (BIOS) is firmware that is first run when the computer is turned on and can be configured by the end user
<b>CODEC</b>	The Compressor-Decompressor (CODEC) encodes and decodes digital audio data on the system.
<b>CMOS</b>	Complimentary metal-oxide-conductor is an integrated circuit used in chips like static RAM and microprocessors.
<b>COM</b>	COM refers to serial ports. Serial ports offer serial communication to expansion devices. The serial port on a personal computer is usually a male DB-9 connector.
<b>DAC</b>	The Digital-to-Analog Converter (DAC) converts digital signals to analog signals.
<b>DDR</b>	Double Data Rate refers to a data bus transferring data on both the rising and falling edges of the clock signal.
<b>DMA</b>	Direct Memory Access (DMA) enables some peripheral devices to bypass the system processor and communicate directly with the system memory.

<b>DIMM</b>	Dual Inline Memory Modules are a type of RAM that offer a 64-bit data bus and have separate electrical contacts on each side of the module.
<b>DIO</b>	The digital inputs and digital outputs are general control signals that control the on/off circuit of external devices or TTL devices. Data can be read or written to the selected address to enable the DIO functions.
<b>EHCI</b>	The Enhanced Host Controller Interface (EHCI) specification is a register-level interface description for USB 2.0 Host Controllers.
<b>EIDE</b>	Enhanced IDE (EIDE) is a newer IDE interface standard that has data transfer rates between 4.0 MBps and 16.6 MBps.
<b>EIST</b>	Enhanced Intel® SpeedStep Technology (EIST) allows users to modify the power consumption levels and processor performance through application software. The application software changes the bus-to-core frequency ratio and the processor core voltage.
<b>FSB</b>	The Front Side Bus (FSB) is the bi-directional communication channel between the processor and the Northbridge chipset.
<b>GbE</b>	Gigabit Ethernet (GbE) is an Ethernet version that transfers data at 1.0 Gbps and complies with the IEEE 802.3-2005 standard.
<b>GPIO</b>	General purpose input
<b>HDD</b>	Hard disk drive (HDD) is a type of magnetic, non-volatile computer storage device that stores digitally encoded data.
<b>ICH</b>	The Input/Output Control Hub (ICH) is an Intel® Southbridge chipset.
<b>IrDA</b>	Infrared Data Association (IrDA) specify infrared data transmission protocols used to enable electronic devices to wirelessly communicate with each other.
<b>L1 Cache</b>	The Level 1 Cache (L1 Cache) is a small memory cache built into the system processor.
<b>L2 Cache</b>	The Level 2 Cache (L2 Cache) is an external processor memory cache.
<b>LCD</b>	Liquid crystal display (LCD) is a flat, low-power display device that consists of two polarizing plates with a liquid crystal panel in between.

## ICE-CV-D25502/N26002 COM Express Module

<b>LVDS</b>	Low-voltage differential signaling (LVDS) is a dual-wire, high-speed differential electrical signaling system commonly used to connect LCD displays to a computer.
<b>POST</b>	The Power-on Self Test (POST) is the pre-boot actions the system performs when the system is turned-on.
<b>RAM</b>	Random Access Memory (RAM) is volatile memory that loses data when power is lost. RAM has very fast data transfer rates compared to other storage like hard drives.
<b>SATA</b>	Serial ATA (SATA) is a serial communications bus designed for data transfers between storage devices and the computer chipsets. The SATA bus has transfer speeds up to 1.5 Gbps and the SATA II bus has data transfer speeds of up to 3.0 Gbps.
<b>S.M.A.R.T</b>	Self Monitoring Analysis and Reporting Technology (S.M.A.R.T) refers to automatic status checking technology implemented on hard disk drives.
<b>UART</b>	Universal Asynchronous Receiver-transmitter (UART) is responsible for asynchronous communications on the system and manages the system's serial communication (COM) ports.
<b>UHCI</b>	The Universal Host Controller Interface (UHCI) specification is a register-level interface description for USB 1.1 Host Controllers.
<b>USB</b>	The Universal Serial Bus (USB) is an external bus standard for interfacing devices. USB 1.1 supports 12Mbps data transfer rates and USB 2.0 supports 480Mbps data transfer rates.
<b>VGA</b>	The Video Graphics Array (VGA) is a graphics display system developed by IBM.

Appendix

D

# Watchdog Timer

---





**NOTE:**

The following discussion applies to DOS environment. Contact IEI support or visit the IEI website for specific drivers for other operating systems.

The Watchdog Timer is provided to ensure that standalone systems can always recover from catastrophic conditions that cause the CPU to crash. This condition may have occurred by external EMIs or a software bug. When the CPU stops working correctly, Watchdog Timer either performs a hardware reset (cold boot) or a Non-Maskable Interrupt (NMI) to bring the system back to a known state.

A BIOS function call (INT 15H) is used to control the Watchdog Timer.

INT 15H:

AH – 6FH Sub-function:	
AL – 2:	Sets the Watchdog Timer’s period.
BL:	Time-out value (Its unit-second is dependent on the item “Watchdog Timer unit select” in CMOS setup).

**Table D-1: AH-6FH Sub-function**

Call sub-function 2 to set the time-out period of Watchdog Timer first. If the time-out value is not zero, the Watchdog Timer starts counting down. When the timer value reaches zero, the system resets. To ensure that this reset condition does not occur, calling sub-function 2 must periodically refresh the Watchdog Timer. However, the watchdog timer is disabled if the time-out value is set to zero.

A tolerance of at least 10% must be maintained to avoid unknown routines within the operating system (DOS), such as disk I/O that can be very time-consuming.



**NOTE:**

When exiting a program it is necessary to disable the Watchdog Timer, otherwise the system resets.

**EXAMPLE PROGRAM:**

**; INITIAL TIMER PERIOD COUNTER**

;

**W\_LOOP:**

;

```

MOV      AX, 6F02H      ;setting the time-out value
MOV      BL, 30         ;time-out value is 48 seconds
INT      15H

```

;

**; ADD THE APPLICATION PROGRAM HERE**

;

```

CMP      EXIT_AP, 1     ;is the application over?
JNE      W_LOOP        ;No, restart the application

```

```

MOV      AX, 6F02H      ;disable Watchdog Timer
MOV      BL, 0         ;
INT      15H

```

;

**; EXIT ;**

Appendix

E

# Hazardous Materials Disclosure

---

## **E.1 Hazardous Materials Disclosure Table for IPB Products Certified as RoHS Compliant Under 2002/95/EC Without Mercury**

The details provided in this appendix are to ensure that the product is compliant with the Peoples Republic of China (China) RoHS standards. The table below acknowledges the presences of small quantities of certain materials in the product, and is applicable to China RoHS only.

A label will be placed on each product to indicate the estimated “Environmentally Friendly Use Period” (EFUP). This is an estimate of the number of years that these substances would “not leak out or undergo abrupt change.” This product may contain replaceable sub-assemblies/components which have a shorter EFUP such as batteries and lamps. These components will be separately marked.

Please refer to the table on the next page.

## ICE-CV-D25502/N26002 COM Express Module

Part Name	Toxic or Hazardous Substances and Elements					
	Lead (Pb)	Mercury (Hg)	Cadmium (Cd)	Hexavalent Chromium (CR(VI))	Polybrominated Biphenyls (PBB)	Polybrominated Diphenyl Ethers (PBDE)
<b>Housing</b>	X	O	O	O	O	X
<b>Display</b>	X	O	O	O	O	X
<b>Printed Circuit Board</b>	X	O	O	O	O	X
<b>Metal Fasteners</b>	X	O	O	O	O	O
<b>Cable Assembly</b>	X	O	O	O	O	X
<b>Fan Assembly</b>	X	O	O	O	O	X
<b>Power Supply Assemblies</b>	X	O	O	O	O	X
<b>Battery</b>	O	O	O	O	O	O

O: This toxic or hazardous substance is contained in all of the homogeneous materials for the part is below the limit requirement in SJ/T11363-2006

X: This toxic or hazardous substance is contained in at least one of the homogeneous materials for this part is above the limit requirement in SJ/T11363-2006

此附件旨在确保本产品符合中国 RoHS 标准。以下表格标示此产品中某有毒物质的含量符合中国 RoHS 标准规定的限量要求。

本产品上会附有“环境友好使用期限”的标签，此期限是估算这些物质“不会有泄漏或突变”的年限。本产品可能包含有较短的环境友好使用期限的可替换元件，像是电池或灯管，这些元件将会单独标示出来。

部件名称	有毒有害物质或元素					
	铅 (Pb)	汞 (Hg)	镉 (Cd)	六价铬 (CR(VI))	多溴联苯 (PBB)	多溴二苯 醚 (PBDE)
壳体	X	O	O	O	O	X
显示	X	O	O	O	O	X
印刷电路板	X	O	O	O	O	X
金属螺帽	X	O	O	O	O	O
电缆组装	X	O	O	O	O	X
风扇组装	X	O	O	O	O	X
电力供应组装	X	O	O	O	O	X
电池	O	O	O	O	O	O

O: 表示该有毒有害物质在该部件所有物质材料中的含量均在 SJ/T11363-2006 标准规定的限量要求以下。  
X: 表示该有毒有害物质至少在该部件的某一均质材料中的含量超出 SJ/T11363-2006 标准规定的限量要求。